



UNIVERSITÀ DEGLI STUDI DI MILANO



Scuola di dottorato in scienze  
biologiche e molecolari  
*PhD. School in biomolecular sciences*  
XXIII ciclo

**Identification of three novel regulatory  
pathways involved in the down-regulation of  
p63 protein levels**

Dr. Francesco Galli  
Matricola N°R07574

TUTOR: Dr. Luisa Guerrini

COORDINATORE DEL DOTTORATO: Prof. Roberto Mantovani

**Anno Accademico  
2009-2010**

# INDEX

<b>INTRODUCTION</b>	pag. 3
1. The p53 protein family	pag. 4
2. Structure of the <i>p63</i> gene	pag. 5
3. Role of p63 in development	pag. 6
4. Human syndromes associated to p63 mutations	pag. 9
Ectrodactyly, Ectodermal dysplasia, and Cleft lip/palate (EEC) syndrome	pag. 10
Limb Mammary Syndrome (LMS)	pag. 11
Acro-Dermato-Ungual-Lacrimal-Tooth (ADULT) Syndrome	pag. 11
Ankyloblepharon-Ectodermal dysplasia-Clefting (AEC) syndrome	pag. 12
Split Hand-Foot Malformation type IV (SHFM-IV)	pag. 12
5. Role of p63 in response to DNA damage	pag. 14
6. Role of p63 in cancer	pag. 15
7. Regulation of p63 protein expression	pag. 16
<b>RESULTS AND DISCUSSION</b>	pag. 21
MDM2 and Fbw7 cooperate to induce p63 protein degradation following DNA damage and cell differentiation	pag. 22
Induction of cell cycle arrest by the dual activity of TRIM8 on p53 and $\Delta$ Np63	pag. 24
Hipk2 phosphorylates DNp63a and promotes its degradation in response to DNA damage	pag. 25
<b>GENERAL DISCUSSION</b>	pag. 27
<b>APPENDIX</b>	pag. 30
<b>BIBLIOGRAPHY</b>	pag. 34

# INTRODUCTION

## 1. The p53 protein family

The tumor suppressor p53 is the most commonly mutated gene in human cancers and is the key regulator of responses to many types of cellular stresses, including DNA damage. When activated by the appropriate signals, p53 can induce cell cycle arrest and/or apoptosis and loss of p53 activity is considered to be ubiquitous to all cancers (Moll et al. 2001).

Recently two p53 homologues, p63 and p73, have been identified; the three p53 family members share significant similarities within three domains: the TransActivation domain (TA), the DNA Binding Domain (DBD) and the Oligomerization Domain (OD). (Fig.1).

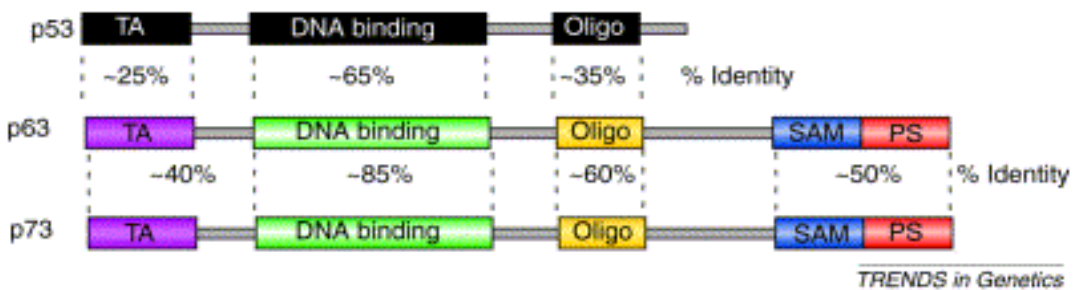
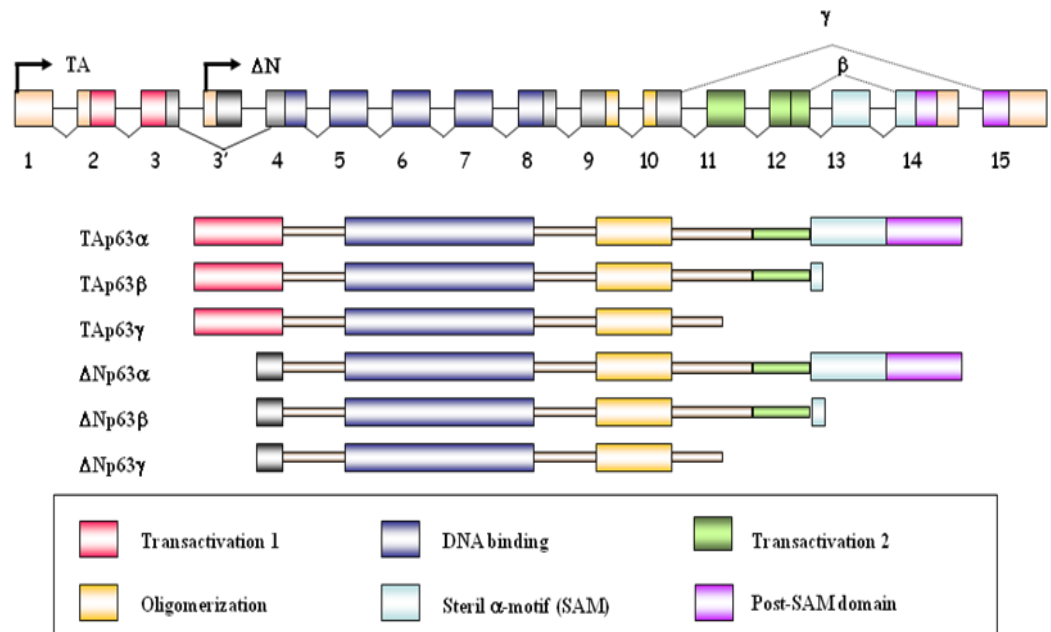

**Fig. 1:** Similarities between family members. p53, p63 and p73 have a very similar structure. The TransActivation domain (TA), DNA Binding Domain (DBD) and Oligomerization domain (Oligo) are present in all p53, p63 and p73 isoforms. The  $\alpha$  isoforms of p63 and p73 possess an additional region which contains the Sterile Alpha Motif (SAM) and Post SAM domains (PS).

The high level of sequence similarity between p63, p73 and p53 proteins, particularly in the DNA binding domain, allows p63 and p73 to bind to p53-responsive genes, causing cell cycle arrest and/or apoptosis. Unlike p53, the genes encoding for p63 and p73 are rarely mutated in human cancer, and neither of the Knock-Out mice models exhibits a propensity for tumor formation, but they present severe developmental defects that are absent in the p53 Knock-Out mice. This is a clear indication that, while p53 is important for the prevention of cancer, both p63 and p73 are crucial for normal development (Harms et al. 2002).

## 2. Structure of the *p63* gene

The *p63* gene is localized on 3q27. In p63 two alternative promoters drive the transcription of either TAp63 proteins, comprising a p53-related N-terminal Trans-Activation (TA1) domain, a DNA-Binding Domain (DBD) and an Oligomerization Domain (OD), or  $\Delta$ Np63 proteins, lacking the TA domain. An additional TA domain (TA2) has been identified within exons 11 and 12 of p63, a region present only in the  $\alpha$  and  $\beta$  isoforms, but not in the  $\gamma$ , that is implicated in the transcriptional activities of the  $\Delta$ Np63 isoforms (Ghioni et al. 2002; Laurikkala et al. 2006) (Fig. 2). A Sterile-Alpha-Motif domain (SAM) and a post-SAM domain are present only in the  $\alpha$ -isoforms (Qiao and Bowie 2005) (Fig. 2). Altogether, the *p63* gene expresses at least six mRNA variants which encode for six different p63 protein isoforms: TAp63 $\alpha$ , TAp63 $\beta$ , TAp63 $\gamma$ ,  $\Delta$ Np63 $\alpha$ ,  $\Delta$ Np63 $\beta$  and  $\Delta$ Np63 $\gamma$  (Fig. 2).



**Fig. 2:** Schematic representation of *p63* isoforms.

A Transactivation Inhibitory Domain (TID) has been found after the SAM domain in the  $\alpha$  isoforms of p63. The TID can bind the TA1 at the N-terminus of TAp63 $\alpha$  by an intra-molecular mechanism, thus inhibiting the transcriptional activity of this isoform (Serber et al. 2002) (Fig. 3).

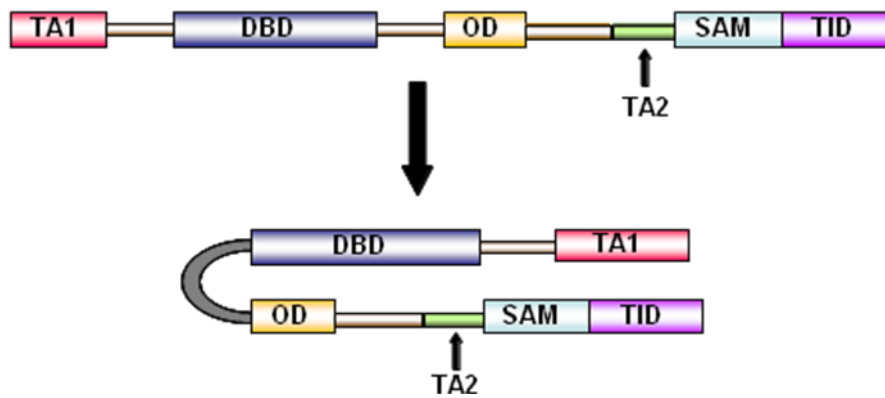

**Fig. 3:** “Intramolecular masking” mechanism.

### 3. Role of p63 in development

The *p63* gene is conserved throughout evolution, and is found in *Xenopus Laevis*, fish, mice and man.

To understand the role of *p63*, in 1999 the Knock-Out (KO) mice for *p63* (*p63*<sup>-/-</sup>) were generated. At birth *p63*<sup>-/-</sup> mice have striking and visible skin defects. Histological analysis of neonatal *p63*<sup>-/-</sup> skin revealed the absence of the normal epidermal structure and complete lack of hair follicles and teeth. The skin surface of *p63*<sup>-/-</sup> mice is covered by a single layer of flattened cells and the spinosum, granulosum and stratum corneum are missing. The water loss-assay, as *in vivo* measure of the functional permeability of the skin, showed that *p63* KO mice lose more water than the *p63* wt mice, and for this reason, they die few hours after birth from dehydration. Furthermore, *p63*<sup>-/-</sup> newborns display striking limb defects. The fore-limbs are truncated while hind-limbs are completely absent in all *p63*<sup>-/-</sup> homozygous mutant animals (Mills et al. 1999; Yang et al. 1999). In all *p63* KO mice fore-limbs skeletal preparations analysed phalanges and carpals were absent, whereas proximal forelimbs structures were slightly heterogenous in the extent of the truncation. For example, the ulna was present in a subset (37,5%) of the limbs, but the radius was not present in any of the mutant limbs analysed. Although the humerus was present in each of the mutant limbs, it was truncated, deformed and smaller than those of wt. The femur and all distal skeletal elements were absent in all of the *p63* KO mice limbs examined (Fig. 4).

The *p53*<sup>-/-</sup> mice develop normally but develop multiple types of tumor with a higher frequency than their wild-type counterparts at young ages (5-6 months

old) (**Donehowere** et al. 1992). Since  $p63^{-/-}$  mice die at birth due to dehydration, it was not possible to observe tumors formation in these mice.

The phenotype of the  $p63$  KO mice suggests an essential role for p63 in the development of the skin, ectoderm-derived tissues and limbs. Recent studies confirmed that  $p63$  is essential for the epithelial stratification program (**Koster and Roop** 2004; **Laurikkala** et al. 2006) and to maintain the proliferation potential of the epithelial stem cells (**Senoo** et al. 2007).

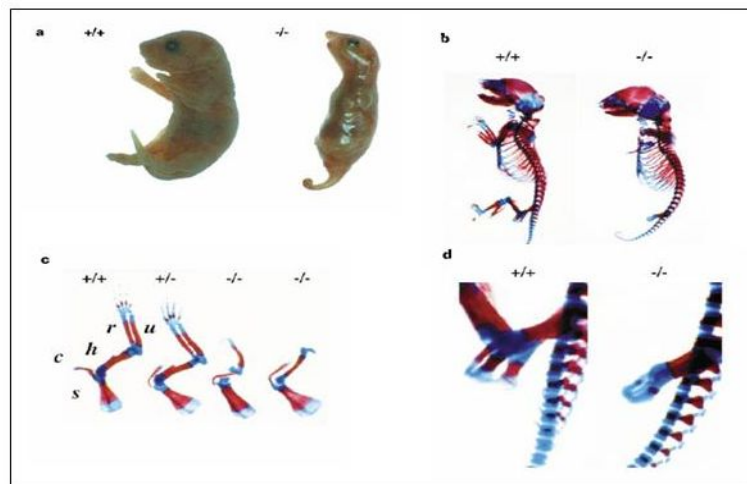

**Fig. 4:** *a. Comparison of the Wild-Type (WT) phenotype (+/+) and Knock-Out (-/-). b. Comparison of the WT skeleton (+/+) and Knock-Out (-/-). c. Fore-limbs skeleton, is known limb truncation in the mutant. d. Pelvic girdle skeleton. It is known absence of the for hind-limbs. Abbreviations: c: clavicle, h: humerus, r: radio, s: scapula, u: ulna.*

During mouse embryogenesis p63 is expressed within the ectoderm of the branchial arches, tail, limbs buds and in the Apical Ectodermal Ridge (AER). The AER is required for normal limb development and it is the most distal tip of the limb bud (**Kuhlman and Niswander** 1997) (Fig. 5).

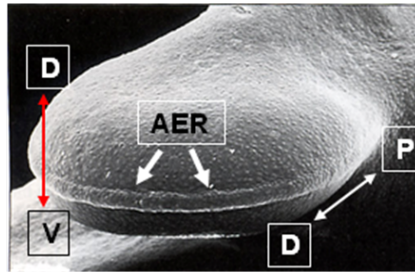

**Fig. 5:** Limb bud at the stage E11. Note the dorsal-ventral symmetry (*V* and *D*, double red arrow), the plan of growth proximo-distal (*P* and *D*, double white arrow) and the position of the Apical Ectodermal Ridge (*AER*, white arrows).

The AER is a pluri-stratified epithelial structure rimming the distal edge of the limb bud required for limb bud growth and patterning along the Proximal-Distal (P-D) axis (Yang 2009). Under the AER there is the Progress Zone (PZ) that receives a proliferative signals and it is maintained in a state of intense cell division activity. These signals sent by the AER induce the growth of the whole structure.

The reduction of limb development in the *p63* KO mice could be associated to a failure in AER function, where *p63* is highly expressed (Fig. 6). The lack of *p63* expression induces a deregulation of the *p63* target genes reducing limb development along the Proximal-Distal (P-D) axis, reflecting the lack of the maintenance of the AER function.

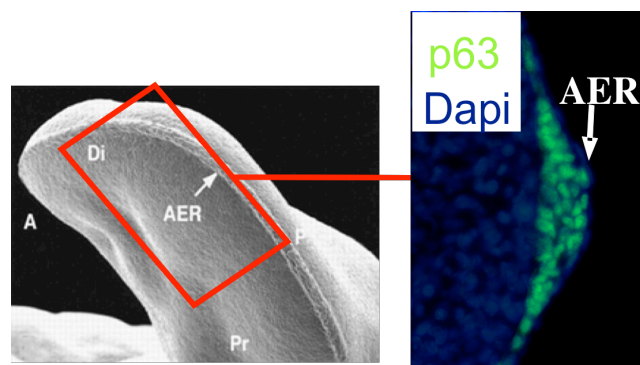

**Fig. 6:** Section of mouse limb at stage E11.5, display in green *p63* nuclear expression in AER (Lo Iacono et al. 2008).



In the mature epidermis, p63 is mainly expressed in the basal layer, while its expression is down-regulated in the differentiated layers. The p63 isoform predominantly expressed in the basal layer is the  $\Delta Np63\alpha$  (**Koster and Roop** 2004). TAp63 $\alpha$ , during mouse epidermal morphogenesis, is the first isoform detected in the single-layer epithelium at stage E7.5, before commitment to stratification.  $\Delta Np63\alpha$  is firstly detected at stage E9.5, before terminal differentiation, but after developing epidermis has committed to stratification. The expression of TAp63 $\alpha$  is down-regulated after this stage, probably because TAp63 $\alpha$  is the molecular switch that start the epithelial stratification program. This program requires a shift in the balance between the p63 isoforms toward  $\Delta Np63\alpha$  expression to allow keratinocytes to respond to signals required for the maturation of the epidermis. When the mature epidermis is formed, the basal layer of the mature epidermis displays elevated p63 levels that are required for maintaining the proliferative potential of keratinocytes (**Koster et al.** 2004).

In case of wound of the epidermis and the dermal tissue, the repair mechanisms induce the formation of new layers of epidermal cells. In the wound region, during tissue repair, it is possible to detect the presence of several p63 isoforms, TAp63 $\alpha$ , TAp63 $\gamma$ ,  $\Delta Np63\alpha$  and  $\Delta Np63\gamma$ , demonstrating that an interplay between the main isoforms of the p63 family is needed not only during development but also for re-epithelization to occur (**Bamberger et al.** 2005).

#### **4. Human syndromes associated to p63 mutations**

The phenotype of the KO *p63* mice displayed many phenotypic similarities with that of human patients affected by syndromes associated to altered development of the limbs and skull. These similarities induced the search for p63 mutation in these human syndromes, for which the disease gene was unknown.

Mutations of the p63 gene have been found in at least five distinct human malformation syndromes (Fig. 7). These syndromes are characterized by limb abnormalities that fit the split hand/foot spectrum and ectodermal dysplasias affecting hair, teeth, nails and sweat glands, absence of mammary glands and a range of other malformations of the facial skeleton and the eyes. These malformations can be largely explained by assuming that the mutations disrupt

normal ectoderm formation and limb malformations are likely due to interferences with normal formation of the AER.

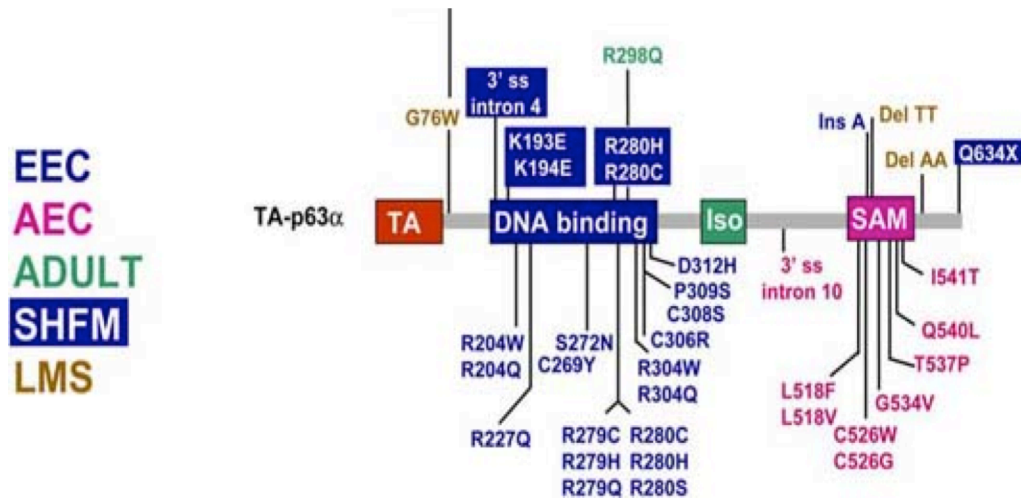

**Fig. 7:** Schematic representation of the localization of *p63* natural mutations that are associated to different human syndromes (**Brunner** et al. 2002).

### **Ectrodactyly, Ectodermal Dysplasia, and Cleft lip/palate (EEC) syndrome**

The EEC syndrome has been linked to two different chromosomes, precisely to the 7q21 (**Haberlandt** et al. 2001; **Tackels-Horne** et al. 2001) and 3q27 (**Celli** et al. 1999), the same chromosome of *p63* gene, loci. Indeed *p63* mutations have been demonstrated in 98% of patients with a classical EEC phenotype (**Celli** et al. 1999; **van Bokhoven** et al. 2001) and EEC syndrome is mainly caused by point mutations in the DBD of the *p63* gene (**Rinne** et al. 2007).

Mutations in *p63*-derived EEC patients have been reported in 152 cases. These comprise 26 families and 60 sporadic cases (**Wessagowit** et al. 2000; **Kosaki** et al. 2001; **van Bokhoven** et al. 2001; **Ray** et al. 2004; **Lehmann** et al. 2005).

The EEC syndrome, the best known human syndrome including ectrodactyly, is also characterized by ectodermal dysplasia and clefting of the lip/palate (**Duijf** et al. 2003; **Rinne** et al. 2006; **Rinne** et al. 2007). EEC patients are invariably characterized by one or more features of ectodermal dysplasia,

which can present as defects of hair, skin, nails, teeth and glands. The severity and type of the ectodermal features is highly variable, and to some extent dependent on the exact nature of the mutation. Only few patients show defects in all of the described ectodermal structures. EEC patients occasionally also have mammary gland/nipple hypoplasia (14 %) and hypohidrosis (11 %). Furthermore two-thirds of these patients display frequently ectrodactyly and syndactyly (43 %). Cleft lip/palate is present in about 40% of the EEC patients, mostly as cleft/lip with or without cleft/palate (**Rinne** et al. 2006; **Rinne** et al. 2007).

### **Limb Mammary Syndrome (LMS)**

Mutations in LMS patients are located in the N- and C-terminus of the *p63* gene (**Rinne** et al. 2007).

The LMS phenotype resembles the EEC phenotype, but the ectodermal manifestations are milder (**van Bokhoven** et al. 1999). A consistent feature of LMS patients is the mammary gland and/or nipple hypoplasia. Lacrimal duct obstruction and dystrophic nails are frequently observed (59 % and 46 % respectively), hypohidrosis and teeth defects are detected in about 30 % but other ectodermal defects such as hair and skin defects are rarely detected. About 70% of LMS patients have similar limb malformations as in EEC syndrome, and about 30% orofacial clefting, notably always in form of cleft palate (**Rinne** et al. 2006; **Rinne** et al. 2007).

### **Acro-Dermato-Ungual-Lacrimal-Tooth (ADULT) syndrome**

Point mutations in ADULT syndrome patients are located in the  $\Delta Np63$  promoter, in the TA domain and in the p63 DBD (**Rinne** et al. 2006; **Rinne** et al. 2007).

The ADULT syndrome phenotype is similar to the LMS syndrome phenotype, although clear differences can be seen. The main difference is the absence of orofacial clefting and the presence of hair and skin defects in the ADULT syndrome. Teeth (100 %), skin (93 %) and nail (100%) defects are constantly present in ADULT syndrome, but only rarely in LMS patients. Hair and lacrimal duct defects (respectively 53 % and 67 %) are observed in ADULT patients more frequently than in LMS patients. Freckling has been reported, but

cannot be considered to be a differentiating feature of this syndrome (**Rinne** et al. 2006; **Rinne** et al. 2007).

### **Ankyloblepharon-Ectodermal dysplasia-Clefting (AEC) syndrome**

AEC patients have point mutations in the SAM domain or deletions in the SAM or TID domains of *p63* (**Rinne** et al. 2006; **Rinne** et al. 2007).

The AEC syndrome phenotype differs from the other conditions mainly by the severity of the skin phenotype, the absence of limb malformations and the occurrence of eyelids fusion at birth. Approximately 80% of the patients have severe skin erosion at birth, which usually recover in the first years of life. The eyelid fusion, also called ankyloblepharon, is present in about 45% of AEC patients, but only rarely in other *p63*-associated conditions. The patients display also nail and teeth defects, present in more than 80 % patients, and hair defects and/or alopecia, present in 94 % of the patients. Occasionally, mammary gland hypoplasia and hypohydrosis occurs (both 13 %), whereas lacrimal duct obstruction is seen in 50% of affected patients. Limb malformations are almost absent. Ectrodactyly has never been reported, but 25% of patients have only mild syndactyly. Cleft palate is present in about 80 % , cleft lip in 44 % and almost 40 % of patients have hearing impairment and genito-urinary defects (**Rinne** et al. 2006; **Rinne** et al. 2007).

### **Split Hand-Foot Malformation type IV (SHFM-IV)**

Up to now, the 3q27 locus is the only SHFM locus for which the causative gene has been identified. Mutations underlying SHFM-IV have been found in the *p63* gene (**Ianakiev** et al. 2001; **van Bokhoven** et al. 2001):

- R58C, a point mutation in the Trans-Activation domain.
- A splice site mutation that predicts an amino acid insertion in the DNA Binding Domain (3'ss intron 4).
- K193E and K194E, two missense mutations in the DNA Binding Domain.
- R280C and R280H, two other mutations in the DNA Binding Domain that have also been encountered many times in patients with EEC syndrome.
- Q634X and E639X, two nonsense mutations that predict carboxy-terminal truncations.

Several mutations involved in SHFM-IV are reported to cause alteration in p63 protein trans-activation potential and stability: the mutations Q634X and E639X are known to disrupt p63 sumoylation site. p63 protein half-life is regulated also by sumoylation and the mutations Q634X and E639X have been demonstrated to alter the stability and transcriptional activity of the p63 $\alpha$  isoforms (Ghioni et al. 2005). Aminoacids K193 and K194 are required for ubiquitin conjugation by E3-ubiquitin ligase Itch and naturally occurring mutations in these aminoacids also cause more stable p63 protein (Rossi et al. 2006). Possibly, SHFM is caused by altered p63 protein turnover with consequent dysregulation of p63 downstream target genes (Rinne et al. 2007; Lo Iacono et al. 2008).



**Fig. 8:** Split Hand Foot Malformation examples. In B, a radiograph showing the absence of the median radius and the syndactyly (Ianakiev et al. 2000).

## 5. Role of p63 in response to DNA damage

Induction of cell cycle arrest and apoptosis in response to cellular stress is the key function to ensure genomic integrity and prevent propagation of genetic errors that leads to tumor formation. It has been demonstrated that p63 was required for p53-dependent apoptosis in response to DNA-damage (**Flores et al. 2002**).

Upon DNA damage eukaryotic cells activate signaling networks leading to cell cycle arrest or apoptosis with c-Abl, a ubiquitously expressed non receptor tyrosine kinase, mediated p53 and p73 protein stabilization. p53 is due to c-Abl phosphorylation of MDM2 on Y394 that prevents p53/MDM2 interaction blocking MDM2 ability to ubiquitinate/degrade p53 (**Puri et al. 2002**). c-Abl directly phosphorylates p73 on Y99 (**Agami et al. 1999**) and stabilizing p73 and enhancing activation of pro-apoptotic genes.

Expression of TAp63 induced apoptosis and cell growth arrest (**Gressner et al. 2005**). In mouse oocytes, cisplatin treatment induces c-Abl mediated TAp63 phosphorylation on a specific tyrosine residues that stabilizes TAp63 promoting p63-dependent activation of pro-apoptotic promoters and consequently a massive drug induced oocyte death (**Gonfloni et al. 2009**), supporting a model in which signals initiated by DNA double-strand breaks are detected by c-Abl, which, through its kinase activity, modulates TAp63 protein activity in oocytes.

In epidermal tissue upon DNA-damaging induced by treatment with UV radiation, cisplatin or adriamycin  $\Delta$ Np63 $\alpha$  transcript levels decreased (**Harmes et al. 2003**). The increased phosphorylation of  $\Delta$ Np63 $\alpha$  following cellular stress mediated p63 ubiquitination and proteasomal degradation (**Westfall et al. 2005**). After DNA-damage induced by treatment with UV radiation p38 MAP-Kinase rapidly mediated  $\Delta$ Np63 $\alpha$  phosphorylation, thus leading to the detachment of  $\Delta$ Np63 proteins from p53-dependent promoters and to the induction of apoptosis mediated by p53 (**Papoutsaki et al. 2005**).

All these findings suggest that TAp63 is a regulator in response to DNA-damage similar to p53, while the down-regulation of the dominant negative  $\Delta$ Np63 can promote functions of TAp63 and p53 to induce apoptosis in response to DNA-damage.

## 6. Role of p63 in cancer

Despite the high similarity with the p53 tumor suppressor, the role of p63 in human tumors is still controversial and p63 mutations were not found in many kind of tumors analyzed. Rather, an aberrant over-expression of  $\Delta Np63$  was found in many epithelial carcinomas, in squamous cell carcinoma (**Hibi et al. 2000**) and in Head and Neck Squamous cell carcinoma (HNSCC) (**Rocco et al. 2006**), skin, lung and cervix (**Nylander et al. 2002**). Further it was shown that over-expression of  $\Delta Np63\alpha$  in human cancers maintains keratinocyte proliferation under conditions that normally induce growth arrest (**King et al. 2003**).  $\Delta Np63\alpha$  over-expression in squamous carcinoma cells suppressed TAp63-dependent pro-apoptotic program and promoted cell survival (**Rocco et al. 2006**) and p63 knockdown led to TAp73-mediated apoptosis (**DeYoung et al. 2006**). Furthermore an oncogenic property of p63 was shown in HNSCC cells by maintaining cell survival. Over-expression of  $\Delta Np63\alpha$  in HNSCC cells induced expression of the cancer stem cell marker CD44, suggesting a role of p63 in the regulation of adhesion, metastasis and the cancer stem cell phenotype (**Boldrup et al. 2007**). Elevated p63 in cancers could cause aberrant activation of cell growth progression genes, indicating its contributions to cancer initiation and progression (**Lefkimiatis et al. 2009**). Interestingly p63 over-expression was associated with poor prognosis in HNSCC cells (**Lo Muzio et al. 2007**) while at the same time lower expression of p63 was associated with poor prognosis in esophageal squamous cell carcinoma (**Takahashi et al. 2006**). Loss of  $\Delta Np63\alpha$  expression was found in bladder cancer and was associated with increased metastasis (**Koga et al. 2003**). The role of p63 in different cancer types is controversial and p63 seems to have multiple functions. It is possible that  $\Delta Np63\alpha$  acts in two different ways, promoting early steps in tumorigenesis by protecting cells from growth arrest and apoptosis, and at the same time acting as a metastasis suppressor by maintaining the epithelial character of cancer cells (**Barbieri and Pietenpol 2006**).

$p53^{-/-}$  and  $p53^{+/-}$  mice are highly tumor-prone with the majority of mice developing spontaneous tumors by 10 months and 2 years, respectively (**Donehower et al. 1992**; **Jacks et al. 1994**). The effect of germ-line deficiency of p63 in cancer could not be evaluated since mice lacking p63 die few hours after birth (**Mills et al. 1999**; **Yang et al. 1999**). p63 heterozygous mice ( $p63^{+/-}$ ), aged

for two years, develop malignant lesions with a frequency that is consistently higher than normal mice. In addition to that, p63 heterozygous mice (p63<sup>+/-</sup>) in combination with p53 heterozygous mice (p53<sup>+/-</sup>) lead to a tumor phenotype which is more aggressive than the phenotype of heterozygous p53<sup>+/-</sup> mice, thus demonstrating that p63 can take part in tumor suppression (**Flores et al. 2005**).

## 7. Regulation of p63 protein expression

p63 activity is regulated by post-translational modification. Post-translational modifications have an important role in the regulation of the biological activity of a protein because they allow both to extend the range of functions of a protein and to monitor the activity and determine the activation or inactivation of the protein.

p63 protein stability is regulated by protein modification such as acetylation, phosphorylation, ubiquitylation and sumoylation. It has been reported that several distinct mechanisms control p63 protein levels. Proteasome and lysosomes have both been found to be involved in p63 protein degradation (**Watson and Irwin 2006**). Many protein modifications and different mechanisms are involved in the regulation of the p63 protein expression; the following are some of the main mechanisms involved in regulation of p63 protein expression levels:

1. The Dlx3 homeodomain protein function as a transcriptional activator expressed in superbasal layer of stratified epidermis, ectodermal appendage such as tooth and hair follicle, bone and placenta (**Hassan et al. 2004**). Targeted deletion of the Dlx3 in mice gene is lethal because of placental defects (**Morasso et al. 1999**). Dlx3 has a role in the post-translational regulation of  $\Delta$ Np63 $\alpha$  protein levels during epidermal differentiation. Raf1 kinase, essential for epidermal differentiation, can directly interact with Dlx3 inducing Raf1 kinase phosphorylation at serine 338 (S338); subsequently Raf1 kinase can bind and directly phosphorylate p63 on threonine 397 (T397) thereby targeting the p63 protein for degradation by a proteasome-dependent pathway. Dlx3 seems to control  $\Delta$ Np63 $\alpha$  protein levels during differentiation of stratified epithelia (**Di Costanzo et al. 2008**).



2.  $\Delta$ Np63 $\alpha$  proteasomal degradation, in response to genotoxic stress has been proposed to involve RACK-1, a scaffold protein containing seven WD-40 repeats, found in proteins that target substrates for degradation through multisubunit E3 ligases, and mediate multiprotein interaction (**McCahill** et al. 2002). RACK-1 degrades  $\Delta$ Np63 $\alpha$  protein under both normal and DNA-damaging conditions. In unstressed situations,  $\Delta$ Np63 $\alpha$  protein are kept stable by Stxbp-4, which in turn suppresses RACK-1 activity. Upon DNA-damage, Stxbp-4 itself is down-regulated, allowing  $\Delta$ Np63 $\alpha$  to be rapidly destabilized (**Li** et al. 2009).
3. The E3 ubiquitin ligase Itch/AIP4 and Nedd4 have both been found to be involved in the control of p63 steady state levels. Itch/AIP4, a HECT-type E3-ubiquitin protein ligase important for the regulation of murine epithelia and hematopoietic cell growth, binds to p63 and promotes p63 degradation by both proteasomal and lysosomal pathways (**Rossi** et al. 2006), whereas Nedd4, an other HECT-type E3 ubiquitin ligase, is a protein promoting  $\Delta$ Np63 $\alpha$  ubiquitination and degradation both in cell culture and in zebrafish embryos.
4. The p63 K637 residue is the the target for SUMO-1 (Small Ubiquitin-like MOdifier), a small protein that is covalently attached to substrate proteins via an isopeptide bond between a C-terminal glycine and a lysine residue in the substrate, to modify their protein function. The E1 activating and the E2 conjugation enzymes, involved in sumoylation, are highly related to the same enzymes involved in ubiquitination, but if in the ubiquitination system have been identified many E2 conjugation enzymes, in the SUMO-1 system only one E2 conjugation enzymes is known, Ubc9 (**Seeler** et al. 2003). In contrast to ubiquitination, SUMOylation is known to have different effect: regulation of cellular localization, trascriptional activation and inhibition, modification of histones, modulation of protein involved in DNA repair and protein stabilization. The mechanism through which SUMO-1 protects proteins from degradation is blocking their ubiquitination by competing for the same lysine residues (**Gill** 2004). SUMO-1 acts as a negative regulator of p63 $\alpha$  leading to proteasomal degradation of the  $\Delta$ Np63 $\alpha$  isoform. Interestingly, the p63

mutation E639X, related to the SHFM-IV, falls within SUMO-1 site, disrupting it and affecting the protein stability of p63 (**Ghioni et al. 2005**).

5. As previously said, up-regulation of  $\Delta\text{Np63}\alpha$  might contribute to tumorigenesis by conferring proliferative potential to cancer cells through trans-activation of target genes necessary for cell division (**Sbisa et al. 2006**). These observations suggest that  $\Delta\text{Np63}\alpha$  is a positive regulator of genes necessary for cell cycle progression like cyclins, and it is a negative regulator of genes related to cell cycle inhibition.  $\Delta\text{Np63}\alpha$  and TAp73 have also been reported to be involved in the cellular response to DNA-damage induced by UV light and gamma radiation.  $\Delta\text{Np63}\alpha$  protein levels decrease after UV treatment, with UV treatment inducing a significant alteration in the phosphorylation status of the p63 protein (**Westfall et al. 2005**). The decrease of  $\Delta\text{Np63}\alpha$  protein levels is essential for the apoptotic response: in fact  $\Delta\text{Np63}\alpha$  has anti-apoptotic activities. On the other hand, TAp73 protein levels increase after UV treatment, and the stabilization of p73 is required for activation of the p73-dependent apoptotic response to DNA damage. Recently it has been shown that stabilization of p73, upon UV-induced DNA damage, is dependent on the phosphorylation on tyrosine 99 (Y99) by c-Abl, a ubiquitously expressed non receptor tyrosine kinase that is potently activated in response to DNA damage (**Agami et al 1999**; **Sanchez-Prieto et al 2002**). Also p63 seems to be a target of c-Abl: in fact *Gleevec*, an inhibitor of the tyrosine kinase activity of c-Abl used in the treatment of chronic myeloid leukaemia, down-regulates the expression of  $\Delta\text{Np63}\alpha$  in a dose dependent-manner under both normal and DNA-damaging conditions. This regulation can be explained by *Gleevec*'s inhibition of c-Abl, which in turns could result in  $\Delta\text{Np63}\alpha$  destabilization (**Ongkeko et al. 2006**).
6. Several kinase are known to phosphorylate p53 after UV irradiation including p38, member of the MAP-Kinase family (**Buschmann et al. 2000**).  $\Delta\text{Np63}$  proteins, largely expressed in proliferating keratinocytes, may have an antagonistic function toward p53 (**Yang et al. 1998**). It has been demonstrated that upon UV irradiation, the down-regulation and the functional inactivation of  $\Delta\text{Np63}$  proteins is crucial to allow the efficient transcription of p53

apoptotic target genes. This mechanism involved the phosphorylation of  $\Delta$ Np63 proteins by p38 MAP-Kinase.  $\Delta$ Np63 proteins is rapidly phosphorylated by p38 MAP-Kinase after apoptotic doses of UV irradiation, the consequences of UV-induced  $\Delta$ Np63 proteins phosphorylation is the detachment of  $\Delta$ Np63 proteins from p53-dependent promoters and the transient down-regulation of  $\Delta$ Np63 (**Papoutsaki** et al. 2005).

7. It's well accepted that acetylation of p53 is indispensable for its transcriptional activation. p300 is a transcriptional co-activator that function as integrator of numerous signalling pathways and is utilized by many DNA-binding proteins to activate transcription (**Barlev** et al. 2001). Indeed, the transcriptional co-activator p300 is known to mediated acetylation of p53 and p73 and tune their apoptotic functions (**Mantovani** et al. 2004). It has been demonstrated that the transcriptional co-activator p300 act also as a regulator of the transcriptional factor p63. It has been demonstrated that the transcriptional co-activator p300 acetylates TAp63 $\gamma$  isoform but doesn't acetylated  $\Delta$ Np63 $\gamma$  isoform. Similar to p73 the transcriptional co-activator p300 binds the N-terminal domain of TAp63 $\gamma$  and TAp63 $\gamma$  binds to the N-terminus of the transcriptional co-activator p300. Moreover the transcriptional co-activator p300 stimulated the transcriptional activity of TAp63 $\gamma$  and subsequently the transcriptional co-activator p300 stimulates the induction of p21, a cyclin-dependent kinase inhibitor, whose function is to regulate the cell cycle progression at G<sub>1</sub>, by TAp63 $\gamma$  isoform and consequently enhancing TAp63 $\gamma$  dependent G<sub>1</sub> arrest (**MacPartlin** et al. 2005). The transcriptional co-activator p300 regulates p63 dependent transcription of p21 suggesting that this regulation may be involved in cell differentiation.
8. p53, beside its effects on the modulation of p63 transcription (**Harmes** et al. 2003), plays an important role on the control of p63 stability. p53 is able to bind p63 in the DBD, in the absence of DNA, and to promote p63 degradation through Caspase-1-mediated pathway. The physical interaction between p53 and p63 is essential for the p63 protein level down-regulation mediated by p53, and no further p63 post-translational modifications are needed to observe its

caspase-mediated degradation (**Ratovitsky** et al. 2001). The ability of p53 to mediate  $\Delta$ Np63 degradation may balance the oncogenic and growth stimulating activity of p63 in tumorigenesis during apoptosis or cell cycle arrest.

All these distinct mechanisms seem to play a critical role in regulating the biological activity of p63 by promoting its stabilization, degradation and enhancing p63 transcriptional activity. The regulation of p63 protein expression influences the biological activity of p63 in both physiological and pathological contexts.

The aim of this thesis was to analyze different aspects of the regulation of p63 protein expression in normal condition through the analysis of the molecular mechanisms exerted by different proteins like MDM2, Fbw7, Hipk2 and TRIM8, and then to various stimuli, such as DNA-damage induced by UV treatment and DNA-damage induced by treatment with genotoxic drugs.

# **RESULTS AND DISCUSSION**

## **MDM2 and Fbw7 cooperate to induce p63 protein degradation following DNA damage and cell differentiation**

*Francesco Galli, Mariangela Rossi, Yuri D'Alessandra, Marco De Simone, Teresa Lopardo, Ygal Haupt, Osnat Alseich-Bartok, Shira Anzi, Eitan Shaulian, Viola Calabrò, Girolama La Mantia and Luisa Guerrini; (2010) J Cell Science 123, 2423-2433.*

In the first part of my PhD thesis we have identified a new regulatory pathway involved in the regulation of the p63 protein expression. We have demonstrated that MDM2 and Fbw7 cooperate in regulating  $\Delta$ Np63 protein stability during cellular differentiation and in response to DNA-damage.

MDM2 (Murine Double Minute clone 2) is one of the most important regulators of p53. In normal cells the MDM2 protein binds to the p53 protein and maintains p53 at low levels by increasing its susceptibility to degradation by the 26S proteasome. In fact, MDM2 binds to the N-terminus of p53, thus blocking its transactivation potential, and acts as a ubiquitin ligase, triggering p53's nuclear export and ubiquitin-mediated degradation (**Momand** et al. 2000).

The Fbw7 protein is an E3 ubiquitin ligase that controls the expression of central regulators of cell cycle including cyclin E, Myc, Jun, Aurora A and Notch and it has an essential role for preservation of genomic stability and prevention of tumor formation. Mutations of the Fbw7 gene are associated to a wide spectrum of human cancers suggesting a onco-suppressor role for Fbw7. The existence of three Fbw7 isoforms with different subcellular localization and with multiple Fbw7 substrates protooncogenes, has made understanding of the mechanism of tumor suppression by Fbw7 complex and not completely understood yet.

We demonstrated that MDM2 binds  $\Delta$ Np63 $\alpha$  in the nucleus promoting its translocation to the cytoplasm and that the MDM2 nuclear localization signal is required for  $\Delta$ Np63 $\alpha$  nuclear export and subsequent degradation, while the RING-finger domain of MDM2 is not required to promote  $\Delta$ Np63 $\alpha$  export. We found that in the cytoplasm p63 is targeted for degradation by the Fbw7 E3-ubiquitin ligase and that an efficient degradation of  $\Delta$ Np63 $\alpha$  by Fbw7 requires the GSK3 kinase activity.

In order to clarify the physiological contexts in which the MDM2-Fbw7 pathway is regulating  $\Delta$ Np63 $\alpha$  protein levels, we performed silencing of Fbw7 and MDM2 and demonstrated that degradation of endogenous  $\Delta$ Np63 $\alpha$  in cells exposed to UV irradiation, adriamycin or upon keratinocyte differentiation is dependent on MDM2 or Fbw7 expression.

Our data suggest that both MDM2 and Fbw7 cooperate in order to regulate  $\Delta$ Np63 $\alpha$  levels during epithelia differentiation. Indeed in epithelia, during keratinocytes differentiation down-regulation of  $\Delta$ Np63 $\alpha$ , that supports the proliferative potential of basal cells, is required (**Koster** et al. 2004).

$\Delta$ Np63 $\alpha$  has been shown to be degraded upon exposure of cells to UV and adriamycin (**Papoutasaky** et al. 2005). DNA-damaging agents has opposite effect on  $\Delta$ Np63 $\alpha$  and p53; down-regulation of  $\Delta$ Np63 $\alpha$  while activating p53 (**Petitjean** et al. 2006). It has been proposed that the  $\Delta$ Np63 $\alpha$  oncogenic role is based on its ability to counteract the p53 transcriptional response to DNA-damage, by competing for DNA binding to common target promoters (**Murray-Zmijewski** et al. 2006).

We have demonstrated that indeed the MDM2-Fbw7 pathway contributes to reduce the endogenous or transfected  $\Delta$ Np63 $\alpha$  protein levels when cells are treated with DNA-damaging agents.

The natural mutation of Fbw7 falls within the F-box domain, and we have shown that the integrity of this domain is essential to promote  $\Delta$ Np63 $\alpha$  degradation and ubiquitilation. The over-expression of  $\Delta$ Np63 $\alpha$  seems to be involved in the genesis and progression of tumors and this hypothesis is supported by the finding of  $\Delta$ Np63 $\alpha$  over-expression in many epithelial carcinomas, in squamous cell carcinoma (**Hibi** et al. 2000) and in Head and Neck Squamous cell carcinoma (HNSCC) (**Rocco** et al. 2006), skin, lung and cervix (**Nylander** et al. 2002). Since the molecular mechanisms involved in  $\Delta$ Np63 over-expression are still unknown, our data suggest to study in the future the correlation between  $\Delta$ Np63 $\alpha$  over-expression with Fbw7 mutations.

## **Induction of cell cycle arrest by the dual activity of TRIM8 on p53 and $\Delta$ Np63**

*Mariano Caratozzolo, Lucia Micale, Teresa Lopardo, **Francesco Galli**, Anna Maria D'Erchia, Luisa Guerrini, Graziano Pesole, Elisabetta Sbisà, Giuseppe Merla and Apollonia Tullo; Under revision, on Molecular Cell.*

In the second part of my PhD thesis we described an unknown function for the human TRIM8 gene, a member of TRIPartite Motif protein (TRIM) family, as a key node necessary to enhance p53 oncosuppressor activity and, at the same time, to down-modulate oncogenic  $\Delta$ Np63 $\alpha$  activity.

p53 and p63 play a crucial role in controlling cell proliferation and apoptosis. In order to avoid malignant transformation, p53 and p63 stability and activities are modulated by post-translational modifications and protein-protein interaction (**Alsafadi** et al. 2009). MDM2 is the main regulator of p53 turn-over (**Li** et al.2003) but other modulators are involved in control of p53 stability and functionality (**Le Cam** et al. 2006; **Kruse** et al. 2009).

Our data revealed that TRIM8 over-expression induces MDM2 degradation, which results in increased p53 protein levels and activity. Interestingly Chromatin ImmunoPrecipitation (ChIP) analysis showed that p53 and p63 bind in vivo TRIM8 in the intron-1 of the *TRIM8* gene. Moreover p53 and p63 over-expression resulted in increased TRIM8 mRNA levels.

We investigated the effect of TRIM8 over-expression on the oncogenic  $\Delta$ Np63 $\alpha$ . TRIM8 over-expression resulted in  $\Delta$ Np63 $\alpha$  degradation while the mutants  $\Delta$ Np63 $\alpha$  K494R/K505R was resistant to TRIM8 over-expression suggesting that K494 and K505 are involved in  $\Delta$ Np63 $\alpha$  degradation upon TRIM8 overexpression. Interestingly, the data showed that TRIM8 has a new dual function, increasing p53 protein levels and activity by MDM2 degradation and inducing  $\Delta$ Np63 $\alpha$  degradation through the proteasome pathway by the E3-ligase activity of the ring domain of TRIM8.

All together these data show a new regulatory pathway that control at the same time the activities and the expression of both p53 and p63, indicating



TRIM8 as an interesting new therapeutic target able to simultaneously impair  $\Delta$ Np63 $\alpha$  oncogenic and enhance p53 oncosuppressor activities.

## **Hipk2 phosphorylates $\Delta$ Np63 $\alpha$ and promotes its degradation in response to DNA damage**

*Chiara Lazzari, Andrea Prodosmo, Francesca Siepi, Cinzia Rinaldo, Francesco Galli, Mariapia Gentileschi, Antonio Costanzo, Ada Sacchi, Luisa Guerrini and Silvia Soddu; Under revision, on Oncogene.*

During the last part of my PhD thesis we have clarified the mechanisms regulating p63 protein stability involved in the response to several genotoxic drugs.

Hipk2 (Homeodomain-Interacting Protein Kinase 2), a Ser/Thr kinase identified as co-repressor for homeodomain transcription factor (**Kim** et al. 1998), play a role in cell response to genotoxic agents and to DNA damage, and contributes to induce cell cycle arrest and apoptosis. In response to lethal doses of UV, ionizing radiation, or different anticancer drugs, such as cisplatin, roscovitine and doxorubicin the most characterized function of Hipk2 is to phosphorylate p53 at Serine 46, an apoptosis-specific p53 post-translational modification.

The Hipk2 activity on  $\Delta$ Np63 $\alpha$  promotes its degradation in response to DNA damage. A phosphorylation-dependent pro-degradation Hipk2 function has been reported for c-Myb (**Kanei-Ishii** et al. 2004) suggesting that it could be a normal mechanism to destabilize pro-survival factors. The Hipk2 destabilizing activity on  $\Delta$ Np63 $\alpha$  we have described upon treatment with different anticancer drugs, independently from the *TP53* gene status, further support the concept that Hipk2 contribute to DNA-damage response in p53 dependent and independent manners. We demonstrated that Hipk2, in response to genotoxic drugs, phosphorylate  $\Delta$ Np63 $\alpha$  on a specific residue, threonine 397, and this specific modification contributes to Hipk2-induced degradation of  $\Delta$ Np63 $\alpha$  and that the  $\Delta$ Np63 $\alpha$ T397A mutant, which it is not phosphorylated, is not degraded in the face either of Hipk2 over-expression or doxorubicin treatment.

All together these data suggest a dual role for Hipk2, activator for pro-apoptotic factors, like p53, and inhibitor for anti-apoptotic factor, like  $\Delta$ Np63 $\alpha$ .

Furthermore all these consideration suggest a key role for Hipk2 in tumorigenicity and allow to suppose that tumor-associated inhibition of Hipk2 activity might strongly contribute to chemoresistance in addition to much better characterized events, such as p53 mutation/inactivation or  $\Delta$ Np63 over-expression.

# **GENERAL DISCUSSION**

One way to regulate protein functions is by post-translational modification. Post-translational modifications have an important role in the regulation of biological activity of the protein because they allow both to extend the range of functions of a protein and to monitor the activity and determine the activation or inactivation of a protein. The most common protein post-translational modifications include ubiquitylation, phosphorylation and acetylation play an essential role in cellular functions such as cellular differentiation, apoptosis, DNA repair, antigen processing, and stress response. Under particular conditions abnormal post-translational modifications were found in many diseases like: Alzheimer's disease, Parkinson's disease, induction of different cancer and others. These abnormal post-translational modifications are permanent and can cause loss or alteration of protein function by changing enzyme activities or capacity aggregation (**Stadtman and Levine 2000; Shacter 2000**).

p63 protein stability is regulated by different protein modifications such phosphorylation, ubiquitylation and sumoylation. p63 is known to be degraded by ubiquitin-mediated proteasomal degradation, the E3 ubiquitin ligase NEDD4-like, ubiquitin protein ligase Itch and ubiquitin-like protein SUMO-1 have been shown to directly interact with p63 and regulate p63 protein stability (**Ghioni et al. 2005; Rossi et al. 2006; Rossi et al. 2006**) suggest the importance of regulating p63 to tune its biological activity.

During my PhD thesis we found three novel and distinct mechanisms that are involved in the regulation of the p63 protein levels; all these mechanisms induce p63 degradation. We demonstrated that these mechanisms are relevant in different physiological contexts and that they are involved in the regulation of p63 biological function.

1. MDM2-Fbw7 pathway contribute to reduce  $\Delta Np63\alpha$  protein levels during keratinocytes differentiation and upon DNA-damage induced by UV exposure and adriamycin treatment.
2. TRIM8 plays a role in enhancing p53 anti-oncogenic activity and at the same time down-modulate oncogenic  $\Delta Np63\alpha$  activity.
3. Hipk2 phosphorylates and promotes proteasomal degradation of  $\Delta Np63\alpha$  to enable an effective DNA-damage response induced by genotoxic drugs.

All these evidences indicate that regulation of p63 protein stability is a key mechanism to control p63 activities, in particular during epithelia differentiation and in response to genotoxic agents.

The knowledge and the identification of the molecular mechanisms governing p63 regulation under physiological context might be fundamental for understanding the pathogenesis of human syndromes associated to p63 mutations and the mechanism by which p63 promotes disease development.

We hope that future studies focusing on the mechanisms involved in p63 protein regulation might increase our knowledge on the p63 role in tumorigenicity and in response to anti-cancer therapy to improve anti-cancer therapies.

# APPENDIX

**MDM2 and Fbw7 cooperate to induce p63 protein degradation following DNA damage and cell differentiation**

*Francesco Galli, Mariangela Rossi, Yuri D'Alessandra, Marco De Simone, Teresa Lopardo, Ygal Haupt, Osnat Alseich-Bartok, Shira Anzi, Eitan Shaulian, Viola Calabrò, Girolama La Mantia and Luisa Guerrini;* (2010) *J Cell Science* 123, 2423-2433.

**Induction of cell cycle arrest by the dual activity of TRIM8 on p53 and  $\Delta$ Np63**

*Mariano Caratozzolo, Lucia Micale, Teresa Lopardo, Francesco Galli, Anna Maria D'Erchia, Luisa Guerrini, Graziano Pesole, Elisabetta Sbisà, Giuseppe Merla and Apollonia Tullo; Under revision, on Molecular Cell.*



**Hipk2 phosphorylates  $\Delta$ Np63 $\alpha$  and promotes its degradation in response to DNA damage**

*Chiara Lazzari, Andrea Prodosmo, Francesca Siepi, Cinzia Rinaldo, Francesco Galli, Mariapia Gentileschi, Antonio Costanzo, Ada Sacchi, Luisa Guerrini and Silvia Soddu; Under revision, on Oncogene.*

# BIBLIOGRAPHY

**Agami R., Blandino G., Oren M. and Shaul Y.** Interaction of c-Abl and p73 $\alpha$  and their collaboration to induce apoptosis. *Nature* (1999); 399(6738): 809-13.

**Alsafadi S., Tourpin S., André F., Vassal G. and Ahomadegbe J.C.** P53 family: at the crossroads in cancer therapy. *Curr Med Chem.* (2009); 16(32): 4328-44.

**Bamberger C., Hafner A., Schmale H. and Werner S.** Expression of different p63 variants in healing skin wounds suggests a role of p63 in reepithelialization and muscle repair. *Wound Repair Regen.* (2005); 13(1): 41-50.

**Barbieri C.E. and Pietenpol J.A.** p63 and epithelial biology. *Exp Cell Res.* (2006); 312(6): 695-706.

**Barlev N.A., Liu L., Chehab N.H., Mansfield K., Harris K.G., Halazonetis T.D. and Berger S.L.** Acetylation of p53 activates transcription through recruitment of coactivators/histone acetyltransferases. *Mol Cell.* (2001); 8(6): 1243-54.

**Boldrup L., Coates P.J., Gu X. and Nylander K.** DeltaNp63 isoforms regulate CD44 and keratins 4, 6, 14 and 19 in squamous cell carcinoma of head and neck. *J Pathol.* (2007); 213(4): 384-91.

**Brunner H.G., Hamel B.C.J. and van Bokhoven H.** The p63 gene and other syndromes. *J. Med. Genet.* (2002); 39: 377-381.

**Buschmann T., Adler V., Matusевич E., Fuchs S.Y. and Ronai Z.** p53 phosphorylation and association with murine double minute 2, c-Jun NH2-terminal kinase, p14ARF, and p300/CBP during the cell cycle and after exposure to ultraviolet irradiation. *Cancer Res.* (2000); 60(4): 896-900.

**Celli J., Duijf P., Hamel B.C., Bamshad M., Kramer B., Smits A.P., Newbury-Ecob R., Hennekam R.C., Van Buggenhout G., van Haeringen A., Woods C.G., van Essen A.J., de Waal R., Vriend G., Haber D.A., Yang A., McKeon F., Brunner H.G. and van Bokhoven H.** Heterozygous germline mutations in the p53 homolog p63 are the cause of EEC syndrome. *Cell.* (1999); 99(2): 143-53.

**DeYoung M.P., Johannessen C.M., Leong C.O., Faquin W., Rocco J.W. and Ellisen L.W.** Tumor-specific p73 up-regulation mediates p63 dependence in squamous cell carcinoma. *Cancer Res.* (2006);66(19): 9362-8.

**Di Costanzo A., Festa L., Duverger O., Vivo M., Guerrini L., La Mantia G., Morasso M.I., Calabrò V.** Homeodomain protein Dlx3 induces phosphorylation-dependent p63 degradation. *Cell Cycle.* (2009); 8(8): 1185-95.

**Donehower L.A., Harvey M., Slagle B.L., McArthur M.J., Montgomery C.A. Jr, Butel J.S. and Bradley A.** Mice deficient for p53 are developmentally normal but susceptible to spontaneous tumours. *Nature* (1992); 356(6366): 215-21.

**Duijf P.H.G., van Bokhoven H. and Brunner H.G.** Pathogenesis of split-hand/split-foot malformation. *Hum. Mol. Genet.* (2003); 12: 51-60.

**Flores E.R., Sengupta S., Miller J.B., Newman J.J., Bronson R., Crowley D., Yang A., McKeon F. and Jacks T.** Tumor predisposition in mice mutant for p63 and p73: evidence for broader tumor suppressor functions for the p53 family. *Cancer Cell.* (2005); 7(4): 363-73.

**Flores E.R., Tsai K.Y., Crowley D., Sengupta S., Yang A., McKeon F. and Jacks T.** p63 and p73 are required for p53-dependent apoptosis in response to DNA damage. *Nature* (2002); 416(6880): 560-4.

**Ghioni P., Bolognese F., Duijf P.H., Van Bokhoven H., Mantovani R. and Guerrini L.** Complex transcriptional effects of p63 isoforms: identification of novel activation and repression domains. *Mol Cell Biol.* (2002); 22: 8659-8668.

**Ghioni P., D'Alessandra Y., Mansueto G., Jaffray E., Hay R.T., La Mantia G. and Guerrini L.** The protein stability and transcriptional activity of p63alpha are regulated by SUMO-1 conjugation. *Cell Cycle.* (2005); 4(1): 183-90.

**Gill G.** SUMO and ubiquitin in the nucleus: different functions, similar mechanisms? *Genes Dev.* (2004); 18(17): 2046-59.

**Gonfloni S., Di Tella L., Caldarola S., Cannata S.M., Klinger F.G., Di Bartolomeo C., Mattei M., Candi E., De Felici M., Melino G. and Cesareni G.** Inhibition of the c-Abl-TAp63 pathway protects mouse oocytes from chemotherapy-induced death. *Nat Med.* (2009); 15(10): 1179-85.

**Gressner O., Schilling T., Lorenz K., Schulze Schleithoff E., Koch A., Schulze-Bergkamen H., Lena A.M., Candi E., Terrinoni A., Catani M.V., Oren M., Melino G., Krammer P.H., Stremmel W. and Müller M.** TAp63alpha induces apoptosis by activating signaling via death receptors and mitochondria. *EMBO J.* (2005); 24(13): 2458-71.

**Haberlandt E., Löffler J., Hirst-Stadlmann A., Stöckl B., Judmaier W., Fischer H., Heinz-Erian P., Müller T., Utermann G., Smith R.J. and Janecke A.R.** Split hand/split foot malformation associated with sensorineural deafness, inner and middle ear malformation, hypodontia, congenital vertical talus, and deletion of eight microsatellite markers in 7q21.1-q21.3. *J Med Genet.* (2001);38(6):405-9.

**Harmes D.C., Bresnick E., Lubin E.A., Watson J.K., Heim K.E., Curtin J.C., Suskind A.M., Lamb J. and DiRenzo J.** Positive and negative regulation of deltaN-p63 promoter activity by p53 and deltaN-p63-alpha contributes to differential regulation of p53 target genes. *Oncogene.* (2003); 22(48): 7607-16.

**Harms K., Nozell S. and Chen X.** The common and distinct target genes of the p53 family transcription factors. *Cell Mol Life Sci.* (2004); 61(7-8): 822-42.

**Hassan M.Q., Javed A., Morasso M.I., Karlin J., Montecino M., van Wijnen A.J., Stein G.S., Stein J.L. and Lian J.B.** Dlx3 transcriptional regulation of osteoblast differentiation: temporal recruitment of Msx2, Dlx3, and Dlx5 homeodomain proteins to chromatin of the osteocalcin gene. *Mol Cell Biol.* (2004); 24(20): 9248-61.

**Hibi K., Trink B., Patturajan M., Westra W.H., Caballero O.L., Hill D.E., Ratovitski E.A., Jen J. and Sidransky D.** AIS is an oncogene amplified in squamous cell carcinoma. *Proc Natl Acad Sci U S A.* (2000); 97(10): 5462-7.

**Ianakiev P., Kilpatrick M.W., Toudjarska I., Basel D., Beighton P. and Tsiouras P.** Split-hand/split-foot malformation is caused by mutations in the p63 gene on 3q27. *Am J Hum Genet.* (2000); 67(1): 59-66.

**Jacks T., Remington L., Williams B.O., Schmitt E.M., Halachmi S., Bronson R.T. and Weinberg R.A.** Tumor spectrum analysis in p53-mutant mice. *Curr Biol.* (1994); 4(1): 1-7.

**Kanei-Ishii C., Ninomiya-Tsuji J., Tanikawa J., Nomura T., Ishitani T., Kishida S., Kokura K., Kurahashi T., Ichikawa-Iwata E., Kim Y., Matsumoto K. and Ishii S.** Wnt-1 signal induces phosphorylation and degradation of c-Myb protein via TAK1, HIPK2, and NLK. *Genes Dev.* (2004); 18(7): 816-29.

**Kim Y.H., Choi C.Y., Lee S.J., Conti M.A. and Kim Y.** Homeodomain-interacting protein kinases, a novel family of co-repressors for homeodomain transcription factors. *J Biol Chem.* (1998); 273(40): 25875-9.

**King K.E., Ponnampereuma R.M., Yamashita T., Tokino T., Lee L.A., Young M.F. and Weinberg W.C.** deltaNp63alpha functions as both a positive and a negative transcriptional regulator and blocks in vitro differentiation of murine keratinocytes. *Oncogene.* (2003); 22(23): 3635-44.

**Koga F., Kawakami S., Fujii Y., Saito K., Ohtsuka Y., Iwai A., Ando N., Takizawa T., Kageyama Y. and Kihara K.** Impaired p63 expression associates with poor prognosis and uroplakin III expression in invasive urothelial carcinoma of the bladder. *Clin Cancer Res.* (2003); 9(15): 5501-7.

**Kosaki R., Ohashi H., Yoshihashi H., Suzuki T. and Kosaki K.** A de novo mutation (R279C) in the P63 gene in a patient with EEC syndrome. *Clin Genet.* (2001); 60(4): 314-5.

**Koster M.I. and Roop D.R.** The role of p63 in development and differentiation of the epidermis. *J Dermatol Sci.* (2004); 34(1): 3-9.

**Koster M.I., Kim S., Mills A.A., DeMayo F.J. and Roop D.R.** p63 is the molecular switch for initiation of an epithelial stratification program. *Genes Dev.* (2004); 18(2): 126-31.

**Kruse J.P. and Gu W.** MSL2 promotes Mdm2-independent cytoplasmic localization of p53. *J Biol Chem.* (2009); 284(5): 3250-63.

**Kuhlman J. and Niswander L.** Limb deformity proteins: role in mesodermal induction of the apical ectodermal ridge. *Development* (1997); 124(1): 133-9.

**Laurikkala J., Mikkola M.L., James M., Tummers M., Mills A.A. and Thesleff I.** p63 regulates multiple signalling pathways required for ectodermal organogenesis and differentiation. *Development*. (2006); 133(8): 1553-63.

**Le Cam L, Linares LK, Paul C, Julien E, Lacroix M, Hatchi E, Triboulet R, Bossis G, Shmueli A, Rodriguez MS, Coux O, Sardet C.** E4F1 is an atypical ubiquitin ligase that modulates p53 effector functions independently of degradation. *Cell*. (2006) ; 127(4): 775-88.

**Lefkimiatis K., Caratozzolo M.F., Merlo P., D'Erchia A.M., Navarro B., Levrero M., Sbisà E. and Tullo A.** p73 and p63 sustain cellular growth by transcriptional activation of cell cycle progression genes. *Cancer Res.* (2009); 69(22): 8563-71.

**Lehmann K., Mundlos S. and Meinecke P.** An unusual combination of EEC syndrome and hypomelanosis Ito due to a p63 mutation. *Eur J Pediatr.* (2005); 164(8): 530-1.

**Li M., Brooks C.L., Wu-Baer F., Chen D., Baer R. and Gu W.** Mono- versus polyubiquitination: differential control of p53 fate by Mdm2. *Science.* (2003); 302(5652): 1972-5.

**Li Y., Peart M.J. and Prives C.** Stxbp4 regulates DeltaNp63 stability by suppression of RACK1-dependent degradation. *Mol Cell Biol.* (2009); 29(14): 3953-63.

**Lo Iacono N., Mantero S., Chiarelli A., Garcia E., Mills A.A., Morasso M.I., Costanzo A., Levi G., Guerrini L. and Merlo G.R.** Regulation of Dlx5 and Dlx6 gene expression by p63 is involved in EEC and SHFM congenital limb defects. *Development*. (2008); 135(7): 1377-88.

**Lo Muzio L., Campisi G., Farina A., Rubini C., Pastore L., Giannone N., Colella G., Leonardi R. and Carinci F.** Effect of p63 expression on survival in oral squamous cell carcinoma. *Cancer Invest.* (2007); 25(6): 464-9.

**MacPartlin M., Zeng S., Lee H., Stauffer D., Jin Y., Thayer M. and Lu H.** p300 regulates p63 transcriptional activity. *J Biol Chem.* (2005); 280(34): 30604-10.

**Mantovani F., Piazza S., Gostissa M., Strano S., Zacchi P., Mantovani R., Blandino G. and Del Sal G.** Pin1 links the activities of c-Abl and p300 in regulating p73 function. *Mol Cell.* (2004); 14(5): 625-36.

**McCahill A., Warwicker J., Bolger G.B., Houslay M.D. and Yarwood S.J.** The RACK1 scaffold protein: a dynamic cog in cell response mechanisms. *Mol Pharmacol.* (2002); 62(6): 1261-73.

**Mills A.A., Zheng B., Wang X-J., Vogel H., Roop D.R. and Bradley A.** p63 is a p53 homologue required for limb and epidermal morphogenesis. *Nature* (1999); 398: 708-713.

**Moll U.M., Erster S. and Zaika A.** p53, p63 and p73--solos, alliances and feuds among family members. *Biochim Biophys Acta.* (2001); 1552(2): 47-59.

**Momand J., Wu H.H. and Dasgupta G.** MDM2--master regulator of the p53 tumor suppressor protein. *Gene.* (2000); 242(1-2): 15-29.

**Morasso M.I., Grinberg A., Robinson G., Sargent T.D. and Mahon K.A.** Placental failure in mice lacking the homeobox gene *Dlx3*. *Proc Natl Acad Sci U S A.* (1999); 96(1): 162-7.

**Murray-Zmijewski F., Lane D.P. and Bourdon J.C.** p53/p63/p73 isoforms: an orchestra of isoforms to harmonise cell differentiation and response to stress. *Cell Death Differ.* (2006); 13(6): 962-72.

**Nylander K., Vojtesek B., Nenutil R., Lindgren B., Roos G., Zhanxiang W., Sjöström B., Dahlqvist A. and Coates P.J.** Differential expression of p63 isoforms in normal tissues and neoplastic cells. *J Pathol.* (2002); 198(4): 417-27.

**Ongkeko W.M., Chu T.S., Aguilera J., Dang C.L. Wang-Rodriguez J.** Gleevec suppresses p63 expression in Head and Neck Squamous Cell carcinoma despite activation by DNA-Damaging Agents. *The Laryngoscope* (2006); 116: 1390-1396.

**Papoutsaki M., Moretti F., Lanza M., Marinari B., Sartorelli V., Guerrini L., Chimenti S., Levrero M. and Costanzo A.** A p38-dependent pathway regulates DeltaNp63 DNA binding to p53-dependent promoters in UV-induced apoptosis of keratinocytes. *Oncogene.* (2005); 24(46): 6970-5.

**Petitjean A., Hainaut P. and Caron de Fromental C.** TP63 gene in stress response and carcinogenesis: a broader role than expected. *Bull Cancer.* (2006); 93(12): 126-35.

**Puri PL, Bhakta K, Wood LD, Costanzo A, Zhu J, Wang JY.** A myogenic differentiation checkpoint activated by genotoxic stress. *Nat Genet.* (2002); 32(4): 585-93.

**Qiao F. and Bowie J.U.** The many faces of SAM. *Sci STKE.* (2005); 2005(286): re7.

**Ratovitski E.A., Patturajan M., Hibi K., Trink B., Yamaguchi K. and Sidransky D.** p53 associates with and targets DeltaNp63 into a protein degradation pathway. *Proc Natl Acad Sci U S A.* (2001); 98(4): 1817-22.

**Ray A.K., Marazita M.L., Pathak R., Beever C.L., Cooper M.E., Goldstein T., Shaw D.F. and Field L.L.** TP63 mutation and clefting modifier genes in an EEC syndrome family. *Clin Genet.* (2004); 66(4): 373.

- Rinne T., Brunner H.G. and van Bokhoven H.** p63-associated disorders. *Cell Cycle*. (2007); 6(3): 262-8.
- Rinne T., Hamel B., van Bokhoven H. and Brunner H.G.** Pattern of p63 mutations and their phenotypes--update. *Am J Med Genet A*. (2006); 140(13): 1396-406.
- Rocco J.W., Leong C.O., Kuperwasser N., DeYoung M.P. and Ellisen L.W.** p63 mediates survival in squamous cell carcinoma by suppression of p73-dependent apoptosis. *Cancer Cell*. (2006);9(1) :45-56.
- Rossi M., Aqeilan R.I., Neale M., Candi E., Salomoni P., Knight R.A., Croce C.M. and Melino G.** The E3 ubiquitin ligase Itch controls the protein stability of p63. *Proc Natl Acad Sci U S A*. (2006); 103(34): 12753-8.
- Rossi M., De Simone M., Pollice A., Santoro R., La Mantia G., Guerrini L. and Calabrò V.** Itch/AIP4 associates with and promotes p63 protein degradation. *Cell Cycle*. (2006); 5(16): 1816-22.
- Sanchez-Prieto R., Sanchez-Arevalo V.J., Servitja J. and Gutkind J.S.** Regulation of p73 by c-Abl Through the p38 MAP kinase pathway. *Oncogene* (2002); 21: 974-979.
- Sbisà E., Mastropasqua G., Lefkimmatis K., Caratozzolo M.F., D'Erchia A.M. and Tullo A.** Connecting p63 to cellular proliferation: the example of the adenosine deaminase target gene. *Cell Cycle*. (2006); 5(2): 205-12.
- Seeler J.S. and Dejean A.** Nuclear and unclear functions of SUMO. *Nat Rev Mol Cell Biol*. (2003); 4(9): 690-9.
- Senoo M., Pinto F., Crum C.P. and McKeon F.** p63 Is essential for the proliferative potential of stem cells in stratified epithelia. *Cell* (2007); 129(3): 523-36.
- Serber Z., Lai H.C., Yang A., Ou H.D., Sigal M.S., Kelly A.E., Darimont B.D., Duijf P.H., Van Bokhoven H., McKeon F. and Dotsch V.** A C-terminal inhibitory domain controls the activity of p63 by an intramolecular mechanism. *Mol Cell Biol*. (2002); 22(24): 8601-11.
- Shacter E.** Protein oxidative damage. *Methods Enzymol*. (2000); 319: 428-36.
- Stadtman E.R. and Levine R.L.** Protein oxidation. *Ann N Y Acad Sci*. (2000); 899: 191-208.
- Takahashi Y., Noguchi T., Takeno S., Kimura Y., Okubo M. and Kawahara K.** Reduced expression of p63 has prognostic implications for patients with esophageal squamous cell carcinoma. *Oncol Rep*. (2006); 15(2): 323-8.



**Yang A., Schweitzer R., Sun D., Kaghad M., Walker N., Bronson R.T., Tabin C., Sharpe A., Caput D., Crum C. and McKeon F.** p63 is essential for regenerative proliferation in limb, craniofacial and epithelial development. *Nature* (1999); 398(6729): 714-8.

**Yang Y.** Growth and patterning in the limb: signaling gradients make the decision. *Sci Signal*. (2009); 2(53): pe3.

**Yang A., Kaghad M., Wang Y., Gillett E., Fleming M.D., Dötsch V., Andrews N.C., Caput D. and McKeon F.** p63, a p53 homolog at 3q27-29, encodes multiple products with transactivating, death-inducing, and dominant-negative activities. *Mol Cell*. (1998) ; 2(3): 305-16.

**Tackels-Horne D., Toburen A., Sangiorgi E., Gurrieri F., de Mollerat X., Fischetto R., Causio F., Clarkson K., Stevenson R.E. and Schwartz C.E.** Split hand/split foot malformation with hearing loss: first report of families linked to the SHFM1 locus in 7q21. *Clin Genet*. (2001); 59(1): 28-36.

**van Bokhoven H., Hamel B.C., Bamshad M., Sangiorgi E., Gurrieri F., Duijf P.H., Vanmolkot K.R., van Beusekom E., van Beersum S.E., Celli J., Merx G.F., Tenconi R., Fryns J.P., Verloes A., Newbury-Ecob R.A., Raas-Rotschild A., Majewski F., Beemer F.A., Janecke A., Chitayat D., Crisponi G., Kayserili H., Yates J.R., Neri G. and Brunner H.G.** p63 Gene mutations in eec syndrome, limb-mammary syndrome, and isolated split hand-split foot malformation suggest a genotype-phenotype correlation. *Am J Hum Genet*. (2001); 69(3): 481-92.

**van Bokhoven H., Jung M., Smits A.P., van Beersum S., Rüschenhoff F., van Steensel M., Veenstra M., Tuerlings J.H., Mariman E.C., Brunner H.G., Wienker T.F., Reis A., Ropers H.H. and Hamel B.C.** Limb mammary syndrome: a new genetic disorder with mammary hypoplasia, ectrodactyly, and other Hand/Foot anomalies maps to human chromosome 3q27. *Am J Hum Genet*. (1999); 64(2): 538-46.

**Watson I.R. and Irwin M.S.** Ubiquitin and ubiquitin-like modifications of the p53 family. *Neoplasia*. (2006); 8(8): 655-66.

**Wessagowit V., Mellerio J.E., Pembroke A.C. and McGrath J.A.** Heterozygous germline missense mutation in the p63 gene underlying EEC syndrome. *Clin Exp Dermatol*. (2000); 25(5): 441-3.

**Westfall M.D., Joyner A.S., Barbieri C.E., Livingstone M. and Pietsenpol J.A.** Ultraviolet radiation induces phosphorylation and ubiquitin-mediated degradation of DeltaNp63alpha. *Cell Cycle*. (2005); 4(5): 710-6.