

UNIVERSITÀ DEGLI STUDI DI MILANO



PhD course in Biochemical Sciences, XXX cycle

Department of Medical Biotechnology and Translational Medicine

**THE ROLE OF THE HYPOXIA INDUCIBLE FACTOR
(HIF-1 α) IN MYOGENESIS**

Giulia RESMINI

Supervisor: Prof. Luigi ANASTASIA

Coordinator: Prof. Sandro SONNINO

A.A. 2016/2017

INDEX

Introduction

| | |
|--|----|
| 1. The hypoxia inducible factor (HIF) and its regulation | 3 |
| 1.1. Structure and function of the hypoxia inducible factor (HIF) | 4 |
| 1.2. HIF Prolyl hydroxylases (PHDs) | 7 |
| 1.3. PHDs Inhibitors | 8 |
| 2. Skeletal Muscle Differentiation | 9 |
| 2.1. Mechanisms of myogenesis | 9 |
| 2.2. Role of satellite cells in muscle regeneration | 13 |
| 3. Effects of hypoxia on myogenesis | 14 |
| 3.1. Effects of HIF-1 α activation in skeletal muscle differentiation | 14 |
| 3.2. Role of WNT-family proteins in muscle differentiation | 16 |
| 4. Aim | 20 |

Materials and Methods

| | |
|--|----|
| 1. Cell Cultures | 22 |
| 1.1. Cell Proliferation | 22 |
| 1.2. Cell Viability and Cellular Metabolism | 23 |
| 1.3. Cell Toxicity Tests | 24 |
| 2. Luciferase Assay | 24 |
| 3. WNT7a-promoter Plasmid Construct | 25 |
| 4. Nano-Glo Luciferase Assay | 25 |
| 5. RNA Extraction and Gene Expression by RealTime PCR (qPCR) | 26 |
| 6. Isolation of the Plasma Membranes and Nuclei Compartments | 27 |
| 7. Western Blot Analyses | 27 |
| 8. Immunofluorescence Staining | 28 |
| 9. Chromatin Immunoprecipitation (ChIP) | 28 |
| 10. Statistical Analysis | 30 |

Results

| | |
|---|----|
| 1. Proliferation and Cell Toxicity Assays | 31 |
| 2. Activation of the HIF-1 α pathway under hypoxia | 31 |
| 3. Effects of hypoxia on Myogenesis | 32 |
| 4. Mechanistic Study of HIF-1 α -induced Activation of MyoD | 35 |
| 5. Effects of two commercial PHDs inhibitors on C2C12 cells | 40 |
| 6. Activation of the HIF-1 α pathway | 42 |
| 7. Effects of a Chemical Activation of HIF-1 α on Myogenic Differentiation | 43 |
| 8. Mechanistic study of HIF-1 α -induced Activation of MyoD | 46 |

| | |
|-----------------------------------|----|
| <u>Discussion and conclusions</u> | 49 |
|-----------------------------------|----|

| | |
|---------------------|----|
| <u>Bibliography</u> | 55 |
|---------------------|----|

INTRODUCTION

1. THE HYPOXIA INDUCIBLE FACTOR (HIF) AND ITS REGULATION

Oxygen is the main element present on the earth (Webb et al. 2009) and it is fundamental for life and strongly linked to the evolution of the whole planet. The ability of cells to adapt and maintain homeostasis under hypoxic conditions depends on an highly conserved oxygen-sensing mechanism which regulates the transcription of several genes involved in metabolic adaptation, angiogenesis, energy conservation, erythropoiesis, and cell survival (Gunaratnam and Bonventre 2009). A reduced level or tension of oxygen, called hypoxia, is observed in many situations, such as embryogenesis (Provot and Schipani 2007), exposure to high altitude or physical exercise (Richardson et al. 1995), as well as pathologic conditions (Semenza 2014).

Low oxygen levels can determine cellular dysfunction and eventually cell death, in aerobic organisms (Kaelin and Ratcliffe 2008). In humans, there are two different clinical scenarios of hypoxia: the former regarding the hypoxia localized in the organs such as myocardial infarction, ischemic stroke, organ harvesting for transplantation or surgical procedures associated with cessation of arterial blood supply, the latter occurring as a systemic hypoxia, in example the intense and protracted hypotension, shock and cardiorespiratory arrest (Heyman et al. 2016). Interestingly, each tissue is characterized by a specific hypoxic threshold which depends on the baseline oxygen supply, the metabolic rates, the ability to shift energy metabolism towards anaerobic glycolysis. Thus, it is critical to identify the absolute value of physiological hypoxia, but it is normally defined as a decrease in oxygen tension under the standard concentration present in organ or specific cell types (Heyman et al. 2016). The role of cardiovascular and respiratory systems is to guarantee the proper oxygen supply to cells and tissues (Kaelin and Ratcliffe 2008). The cellular response to oxygen levels' variation is ultimately regulated by hypoxia-inducible factor (HIF) (Greer et al. 2012). HIF has a pivotal role in restoring the homeostasis by promoting glycolysis, erythropoiesis and angiogenesis (Semenza 1996, Wenger and Gassmann 1997) (Iyer et al. 1998). For these reasons, HIF is considered the master regulator of hypoxia processes, and it is able to play a central role in the capacity to acquire resistance to hypoxia.

1.1. STRUCTURE AND FUNCTION OF THE HYPOXIA INDUCIBLE FACTOR (HIF)

The hypoxia-inducible factor (HIF) is a heterodimer composed by an oxygen-sensible α -subunit (HIF-1 α) and a constitutively expressed β -subunit (HIF-1 β or ARNT). Both subunits are part of the basic Helix–Loop–Helix PER-ARNT-SIM (bHLH-PAS) family of transcription factors. Three genes encoding distinct HIF- α isoforms exist in humans: HIF1A, encoding HIF-1 α ; EPAS1, encoding HIF-2 α ; and HIF3A, which is expressed as multiple HIF-3 α splice variants (Makino et al. 2002, Maynard et al. 2003). HIF-1 α , HIF-2 α and HIF-3 α splice variants 1–3 possess an oxygen-dependent degradation domain (ODD) and an N-terminal transactivation domain (NTAD), while HIF-1 α and HIF-2 α possess a C-terminal transactivation domain (CTAD) (Jiang et al. 1997, Pugh et al. 1997, O'Rourke et al. 1999, Hara et al. 2001, Maynard et al. 2003).

The two best characterized HIF- α isoforms (HIF-1 α and HIF-2 α) contain two sites of prolyl hydroxylation and a single site of asparaginyl hydroxylation. HIF-1 α prolyl hydroxylation occurs at two sites (residues Pro⁴⁰² and Pro⁵⁶⁴) lying in the N-terminal (NODD) and C-terminal (CODD) regions of the central ODD in HIF-1 α (Jaakkola et al. 2001). HIF-1 α prolyl hydroxylation supports the interaction with the von Hippel-Lindau ubiquitin E3 ligase complex and targets HIF- α subunits for degradation by the ubiquitin-proteasome pathway (Hon et al. 2002).

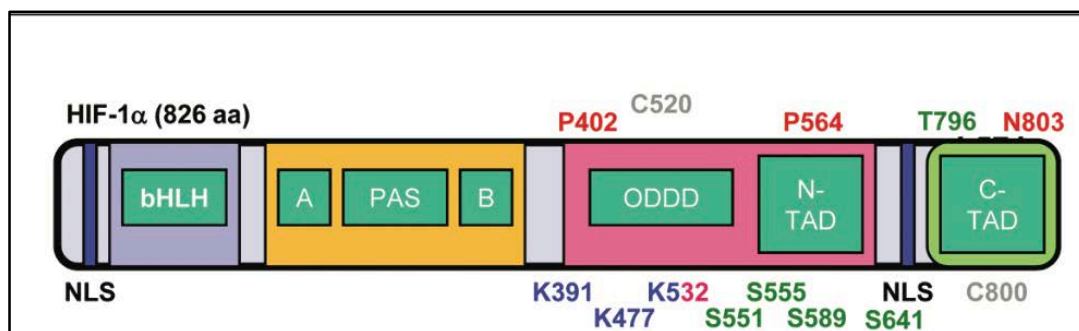

Figure 1. Schematic representation of HIF- α . bHLH = basic helix loop helix domain; PAS = Per-ARNT-Sim motif; ODDD = oxygen-dependent degradation domain; N-TAD = N-terminal transactivation domain; C-TAD = C-terminal transactivation domain. Hydroxylated residues (red).

In normoxia, HIF-1 α is constitutively transcribed and translated to HIF-1 α protein. While in hypoxia, HIF-1 α is hydroxylated and degraded by the ubiquitin-proteasome pathway (Karuppagounder and Ratan 2012). HIF-1 α is hydroxylated on at least one of two conserved proline residues Pro402 and Pro564 within the ODD (Jaakkola et al. 2001) by prolyl-hydroxylase domain (PHDs)-containing enzymes (Epstein et al. 2001) in the presence of oxygen, ferrous iron and ascorbate (Schofield and Ratcliffe 2004). Hydroxylation of HIF-1 α allows it to bind to the Von Hippel-Lindau tumor suppressor protein (pVHL) that acts as a recognition component of E3 ubiquitin

ligase complex. Hydroxylated HIF-1 α is polyubiquitinated at three lysines in the ODD domain and degraded by the 26S proteasome (Paltoglou and Roberts 2007). pVHL is part of a ubiquitin ligase linking the HIF subunits via elongin C and a complex composed of several proteins to the ubiquitination system (Wenger et al. 2005).

An alteration in HIF ubiquitination is followed by HIF- α stabilization, increasing the transcription of its target genes (Haase 2009). In this context, the factor-inhibiting-HIF (FIH) operates in the carboxy-terminal transactivation domain of HIF- α with oxygen-dependent asparagine hydroxylation by blocking CBP/p300 recruitment. Inhibition of FIH upon hypoxia promotes CBP/p300 recruitment, leading to an up-regulation of HIF target genes (Mahon et al. 2001).

While hydroxylation is required for the polyubiquitination and degradation, thus the non-hydroxylated HIF-1 α is stabilized and translocates to the nucleus. In the nucleus, the HIF-1 α binds several factors in order to promote the transcription of specific genes that induce the adaptive response to hypoxia; in particular, HIF-1 α can bind HIF-1 β to form HIF-1 α /HIF-1 β heterodimers, before binding to hypoxia-response elements (HREs) comprising a core 5'-[A/G]CGTG-3' consensus sequence (Wenger et al. 2005). This heterodimer can bind to HREs and recruit specific transcriptional coactivator complexes, including p300/CBP and SRC (steroid receptor coactivator). HIF-1 α and HIF-2 α proteins are closely related and are regulated in a similar manner by oxygen levels, but can differ in their coactivators (Karuppagounder and Ratan 2012).

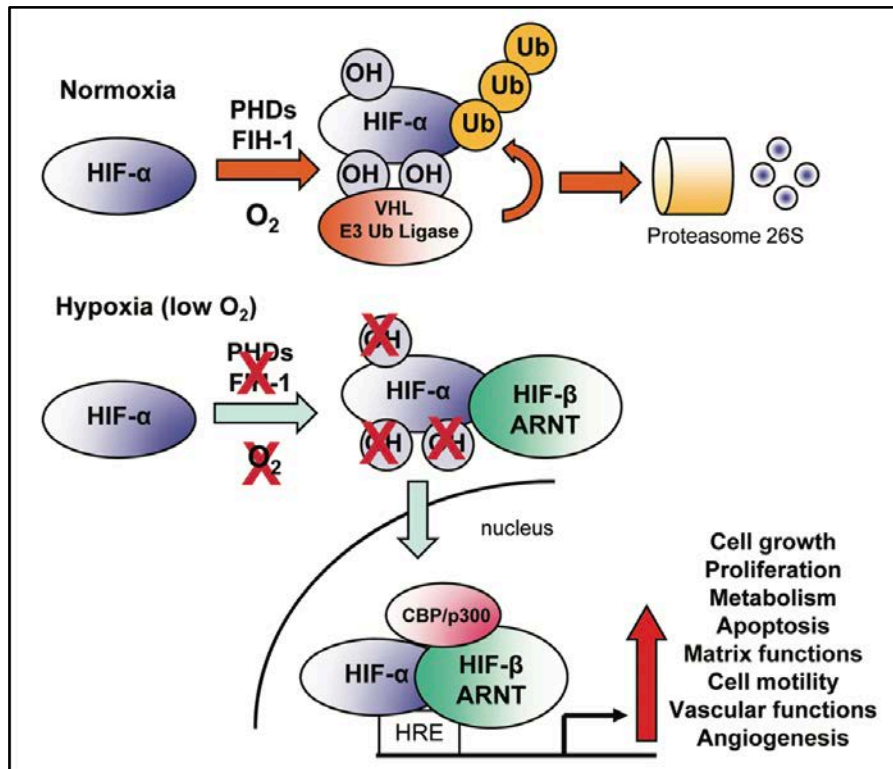

Figure 2. Regulation of hypoxia-inducible factor (HIF) activity. OH = hydroxylation; Ub = ubiquitin.

A milestone in the study of the oxygen-sensing mechanisms has been the control of erythropoietin (EPO) gene expression (Webb et al. 2009). In late 1995, the discovery of the modulation of EPO gene transcription led to the first discovery of HIF family as important transcriptional activators (Wang and Semenza 1995).

It has been reported that HIF regulates about 300 target genes, which promote the hypoxia response pathway to address the oxygen delivery and restrict its use. It is well known that HIF-1 α and HIF-2 α regulate the expression of different pathway, such as glycolysis and EPO, respectively (Kaelin and Ratcliffe 2008). Nowadays, we know that HIF could boast a long list of target genes including hexokinase, phosphofructokinase, aldolase, enolase, glucose transporters, adrenomedullin, heme-oxygenase-1 (HO-1), carbonic anhydrase-9 (CAIX), vascular endothelial growth factor (VEGF), transforming growth factor (TGF), insulin-like growth factor (IGF) and its binding proteins, transferrin, transferrin receptor and ceruloplasmin, nitric oxide synthases, endothelin and endothelin converting enzyme-1 (ECE-1), adrenergic receptors, and many others (Schodel et al. 2011).

Moreover, it has been demonstrated the pivotal role of HIF also in stem cell biology. For example, it was shown that pluripotent embryonic stem cells (ESCs) undergo a metabolic shift towards glycolysis during development (Zhou et al. 2012). Indeed, HIF1 α promotes the transcription of key metabolic enzymes such as pyruvate dehydrogenase kinase-1 (PDK1) (Kim et al. 2006) and

lactate dehydrogenase A (LDHA) (Seagroves et al. 2001). Other HIF target genes include those involved in cell cycle and apoptosis signaling, however, the role of HIF in cell proliferation and survival response is not completely understood (Mason and Johnson 2007).

It is important to notice that HIF-1 α regulates more than 2% of proteins in mammals and controls all apoptotic and angiogenic pathways (Sen Banerjee et al. 2012). Therefore, the regulation of HIF-1 α plays a pivotal role in many cardioprotective approaches (Hirota and Semenza 2006).

1.2. HIF PROLYL HYDROXYLASES (PHDs)

HIF prolyl hydroxylases (PHDs) are oxygen sensors and promote HIF-1 α degradation. As mentioned above, HIF is mainly regulated by oxygen-dependent proteolysis of its α -subunit (Gunaratnam and Bonventre 2009). Thus, PHDs play a pivotal role in the regulation of HIF adaptive response (Myllyharju 2013), while PHD inhibition or HIF stabilization allow a control on HIF target genes (Webb et al. 2009).

PHDs belong to the superfamily of iron and 2-oxoglutarate (2OG)-dependent dioxygenase (Hausinger 2004, Loenarz and Schofield 2008). 2OG oxygenases have a role in different mechanisms, such as: collagen and carnitine biosynthesis, lipid metabolism, histone/nucleic acid modification/repair, ribosome hydroxylation and modification of epidermal growth factor-like domains, and RNA splicing related proteins (Klose and Zhang 2007).

Prolyl hydroxylases are the most important regulators of HIF levels (Bruick and McKnight 2001), these enzymes require molecular oxygen and Fe²⁺ for their reactions (Sen Banerjee et al. 2012).

The first PHD was discovered in *C. Elegans* in 2001 (Epstein et al. 2001), and it was named egg-laying abnormal 9 (EGL-9). Three ortholog human isoforms were next identified and named PHD1 (EGLN2), PHD2 (EGLN1), PHD3 (EGLN3). Alternative splicing variants have been described for PHD2 (Hirsila et al. 2003), PHD3 (Cervera et al. 2006) and a shorter PHD1 isoform result from alternative translational initiation (Tian et al. 2006). The three known PHD isoforms PHD1, PHD2 and PHD3, hydroxylate the HIF-1 α subunit in the presence of oxygen (Sen Banerjee et al. 2012). Their expression level, throughout the body, depends on the types of tissue (Berra et al. 2003). PHD1 is abundant in the testis, PHD2 is ubiquitously expressed, while, PHD3 is expressed in the heart and smooth muscle (Willam et al. 2006). Regarding their localization in the cell, PHD1 was found exclusively in the nucleus, while PHD2 is predominant in the cytoplasm but is able to shuttle in between the cytoplasm and the nucleus. Finally, PHD3 was found to be uniformly distributed in both these cellular compartments (Berra et al. 2003). Among the three PHD family members, PHD2

appears to be the most important in the regulation of HIF-1 α levels (Berra et al. 2003, Minamishima et al. 2008). Indeed, the inactivation of PHD2 strongly dysregulates normal murine embryonic development, resulting in embryonic lethality, whereas PHD1 and PHD3 KO mice are viable (Takeda et al. 2006).

1.3. PHDs INHIBITORS

Hypoxia can be partially mimicked by a number of compounds that inhibit 2OG oxygenases including iron chelators, transition metal ions, and small molecule 2OG analogues. There is widespread interest in the possibility of developing PHDs inhibitors that activate HIF pathways therapeutically in ischemic disease (Myllyharju 2009). In fact, while PHDs were becoming attractive drug targets (Sen Banerjee et al. 2012), PHDs inhibitors gained a protective role in stroke models, but there is still significant work to do to make this a viable therapeutic approach (Karuppagounder and Ratan 2012). The control PHD activity should be a new therapeutic target to regulate the adaptive response to hypoxia. For this reason, several compounds have been used to inhibit PHDs, in order to stabilize HIF, and increase the transcription of its target genes (Heyman et al. 2011). For example, renal EPO synthesis is hastened in animals and humans given DMOG derivatives (Bernhardt et al. 2010), enhancing erythropoiesis. Furthermore, HIF stabilization was found to be organ-protective in renal, cardiac, neural (Corcoran and O'Connor 2013) or gastrointestinal injuries (Hart et al. 2011), to improve graft survival of transplanted organs and to prevent organ damage in septic shock (Heyman et al. 2011). Nonetheless, HIF stabilization results in a non-selective regulation of its gene expression.

In fact, some target genes promote vasoconstriction (endothelin-1), thrombosis (plasminogen activator inhibitor-1) or fibrosis (fibroblast growth factor, connective tissue growth factor). But at the same time induce angiogenesis by VEGF activation, which is beneficial in myocardial infarction (Bao et al. 2010), but detrimental in proliferative retinopathy and macular degeneration (Heyman et al. 2016).

However, it has been reported that GSK360A, a novel orally active PHDs inhibitor, could promote HIF pathway and play a cardioprotective role in rats, improving ventricular function, remodeling, and vascularity (Bao et al. 2010). In addition, it has been recently discovered new tricyclic triazole-containing compounds as potent and selective PHD inhibitors which compete with the 2OG. One compound (IOX4) induces HIF-1 α in cells and in wildtype mice with marked induction in the brain tissue, revealing its therapeutic use in cerebral diseases (Chan et al. 2015). Moreover, IOX2 was identified eligible for study the functional effects of PHDs inhibition in cells and in animals (Chowdhury et al. 2013). FG-4592, also known as Roxadustat, an oral PHDs inhibitor that stimulates erythropoiesis, regulates iron metabolism, and reduces hepcidin, was evaluated in patients with

nondialysis chronic kidney disease (CKD) and is now employed in a clinic trial phase 3 for the treatment of renal anemia (Maxwell and Eckardt 2016).

In general, the activity of PHDs inhibitors is to block the binding of the co-substrate 2OG to the catalytic domain, which is fundamental for enzymatic activity (Fraisl et al. 2009). Therefore, in the last few years several 2OG analogues, such as N-oxalylglycine or its precursor DMOG, have been developed to inhibit PHDs. Moreover, PHDs inhibitors can interfere with the catalytic activity by chelating iron, such as desferrioxamine (DFO). Unfortunately, none of these compounds have an absolute specificity for the distinct PHD sub-types (Fraisl et al. 2009). Finally, metal ions such as Co^{2+} , Cu^{2+} , Zn^{2+} and Mn^{2+} cannot support the enzymatic activity of the PHDs, and therefore also function as inhibitors (Schofield and Ratcliffe 2004). As ascorbate is maintaining iron in its active (reduced) Fe^{2+} state, it is essential for proper PHD function. Several other enzymes host an iron molecule in their catalytic domain, therefore, attempts to inhibit PHDs using chelating agents or ion substitution will probably be non-selective, and result in undesired side effects. Indeed, iron chelation interferes with several other cellular processes, such as oxidative phosphorylation and arachidonic acid signaling (Needleman et al. 1986). The main problem of the commercial available PHDs inhibitors is their lack of specificity. So, further compounds are being developed to be more powerful and selective, as the new aromatic heterocycles, related to pyridine derivatives, including pyrazolopyridines and 8-hydroxyquinolines (Hewitson et al. 2004). The generation of 8-hydroxyquinolines is based on a recently described isoquinoline derivative that specifically inhibits PHDs. In the last few years, it was characterized the identification of dual action PHD inhibitors, such as diacylhydrazines, which bind to the active site iron and also induce the binding of a second iron ion at the active site (Yeoh et al. 2013). It was demonstrated that these compounds have the potential to simultaneously chelate a second transition metal ion when appropriately functionalized with additional metal-chelating groups (Li et al. 2011).

Taken together, these data encourage efforts to develop new PHDs inhibitors, but more information is required to define their function, biological properties, and safety profile.

2. SKELETAL MUSCLE DIFFERENTIATION

2.1. MECHANISMS OF MYOGENESIS

Myogenesis leads to the formation of muscle tissue, which is promoted by the activation of signaling molecules from neighboring tissues which determine myogenic cell fate (Buckingham 2001).

Skeletal muscle cells, or myotubes, are contractile, multinucleated cells, which constitute the minimal functional unit of all muscles in the body. Undifferentiated muscle cells are called myoblasts, they are mononucleated and are characterized by the expression of muscle-specific transcription factors (muscle regulatory factors, MRFs) (Bismuth and Relaix 2010). MRFs, myocyte enhancer factor 2 (Mef2) family and other general and muscle-specific factors are crucial for the differentiation of skeletal muscle cells, and coordinate the expression of target genes during myogenesis (Berkes and Tapscott 2005).

In the embryo, skeletal myogenic progenitors originate from somites (Summerbell and Rigby 2000), which are formed along the rostro-caudal axis of the embryo and are organized in dorso-ventral compartments (Bismuth and Relaix 2010): somites differentiate along the dorso-ventral axis to give rise to the dorsally located epithelial dermomyotome and the ventrally located mesenchymal sclerotome. The dermomyotome gives rise to the dermis and the skeletal muscle of the trunk and limbs, whereas the sclerotome develops into the cartilage and bone. Skeletal muscles originated from the dermomyotome (Bentzinger et al. 2012), and in particular the first muscle fibers are formed, then additional fibers are added using the former as a template (Parker et al. 2003).

It has been observed that myogenic precursors express Pax3, Pax7 and low levels of Myf5 in the dermomyotome (Jostes et al. 1990). The Pax3-expressing cells proliferate as an undifferentiated population due to the secretion of specific signals from the lateral plate mesoderm and surface ectoderm (Amthor et al. 1999). In detail, Pax3 is expressed in the pre-somitic mesoderm and early epithelial somites (Goulding et al. 1994), during the early stages of embryonic development, whereas Pax7 is induced during somite maturation (Jostes et al. 1990). The principal regulator and activator of Pax3 is the genetic network Six-Eya-Dach, which is able to induce, when overexpressed, the up-regulation of Pax3, ultimately promoting muscle differentiation (Kardon et al. 2002).

The high concentrations of FGF and WNT in the caudal area of somites lead to formation of mesenchymal cells in an undifferentiated state (Aulehla and Pourquie 2010) which represent the most ventral part, called the sclerotome, while most dorsally the dermomyotome is comprised of cells that will generate dermis and muscle progenitors cells (MPC) and to the majority of skeletal muscles.

The maturation of a dermomyotome will form the myotome, which contains the first differentiated myofibers and it is characterized by MyoD and Myf5 expression (Kiefer and Hauschka 2001).

Muscle progenitors subsequently fit into the primary myotome, and these will originate a fraction of the satellite cells (SCs) that resides within the postnatal skeletal muscle (Relaix et al. 2005). The epaxial (dorso-medial) part of the myotome will originate the back muscles and is constituted when progenitor cells of the dorsal medial lip (DML) leave the cell cycle and terminally

differentiate (Christ and Ordahl 1995); while the hypaxial (ventro-lateral) somite will generate the rest of the trunk and limb muscles (Parker et al. 2003).

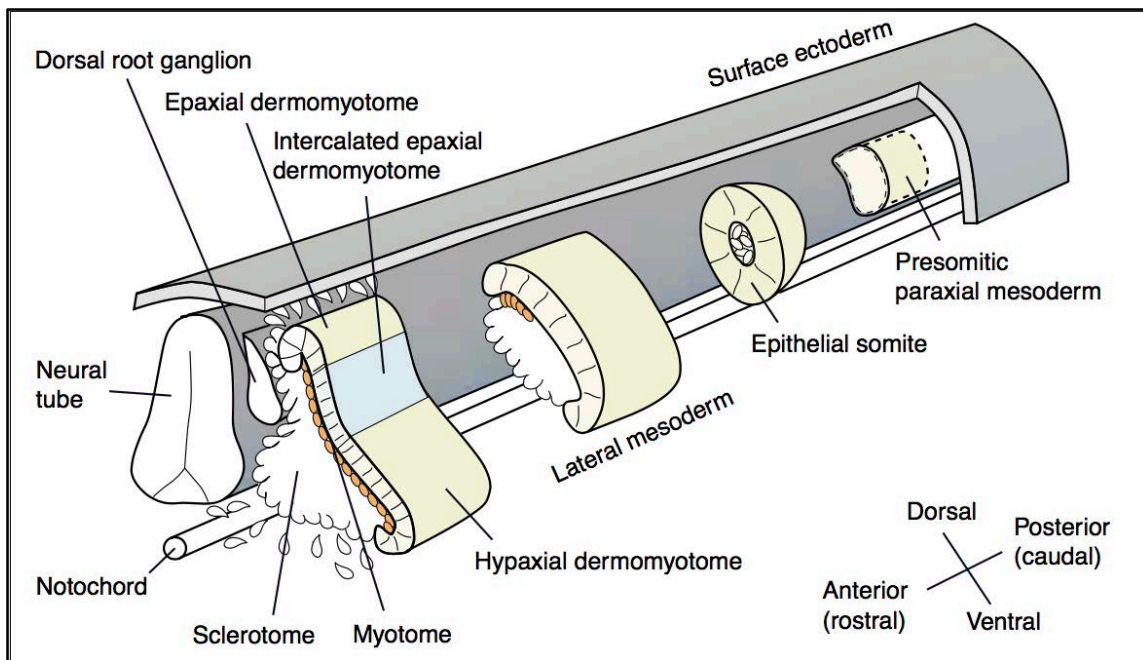

Figure 3. Schematic representation of vertebrate somitogenesis (Buckingham 2001)

In adult, myogenesis is regulated by MRFs, which are expressed in a temporally ordered manner (Yablonka-Reuveni and Rivera 1994). MRFs are constituted by myogenic determination factor 1 (MyoD), myogenic factor 5 (Myf5), myogenin (also known as myogenic factor 4 when first discovered), and myogenic regulatory factor 4 (MRF4, also known as myogenic factor 6 and herculin when first discovered), which are involved in determining the myogenic fate during early embryogenesis (Ludolph and Konieczny 1995).

It has been demonstrated the pivotal role of MRFs during myogenesis, by the binding between their homologous "basic helix-loop-helix" (bHLH) domain and DNA sequence, which gives rise to the dimerization with the E-protein family (Pownall et al. 2002).

Each MRF protein has a different temporal expression which reflects the functional differences (Wilson-Rawls et al. 1999). In particular, the early markers Myf5 and MyoD are necessary for the differentiation of mesodermal cells into myoblasts, while the late myogenin and MRF4 are required for muscle fusion and myotubes differentiation (Ferri et al. 2009).

The myoblast induction (commitment) is driven by Myf5 and MyoD and it is essential for the determination of myogenic line, since both regulate the expression of specific proteins expressed in the muscle, as myogenin, M-cadherin, Myosin Heavy Chain (MHC) and creatin-muscle kinase. Myf5

was first transcribed in cells located at the edges of dermomyotome which later delaminate to form the skeletal muscle of the myotome (Tajbakhsh and Buckingham 2000). MyoD is later activated in hypaxial and epaxial progenitors that generate the mature myotome (Braun et al. 1992). In mutant mice for MyoD, Myf5 remains highly expressed, even if its expression normally decreases after the activation of MyoD. These results show that these two transcription factors are overlapping and each one is able to compensate the absence of the other, according to the gene redundancy. In mice double mutants Myf5/MyoD, the process of myogenesis failed (Rudnicki et al. 1993). Furthermore, transfecting human fibroblasts with a plasmid containing the cDNA of MyoD, it was shown that MyoD is crucial in promoting myogenesis and the induction of myogenin and MHC (Berkes and Tapscott 2005). Myogenin has a pivotal role in the differentiation of myoblasts (Walters et al. 2000) and knockout (KO) mice show the presence of mononuclear cells and rare muscle fibers, revealing that myogenin regulates the fusion of mononuclear myoblasts and the formation of multinucleated fibers called myotubes (Hasty et al. 1993). Furthermore, MRF4 is expressed in differentiated muscle fibers suggesting its involvement in the late stages of muscle differentiation; in fact, MRF4 KO mice develop a normal skeletal muscle with higher levels of expression of myogenin than wildtype mice, suggesting that MRF4 and myogenin are partially overlapping (Zhu and Miller 1997).

Mef2 (myocyte enhancer factors 2) is important for the skeletal muscle fate (Yun and Wold 1996). Although MRFs control myoblast differentiation by regulating gene expression by binding to distinct DNA sequences (E-box) localized in the promoters of muscle-specific genes (Berkes and Tapscott 2005), the complete activation of the expression of these genes depends on their association with other bHLH transcription factors, represented by the Mef2 transcription factors, belonging to the MADS family, which function as transcriptional co-activators of the myogenic proteins (Black et al. 1998). The MADS domain and Mef2 domain that characterize these proteins respectively mediate DNA binding and dimerization (Olson et al. 1995). These factors function as homo- and heterodimers binding consensus sequences rich in A/T present in almost all the myogenic promoters and synergistically with the MRFs proteins alter the chromatin structure, thus promoting the transcription and myogenesis (Naya et al. 1999). The Mef2 factors are not sufficient to induce the myogenic program alone and their expression is under the control of the MyoD family (Dodou et al. 2003). After birth, the expression of Mef2 decreases, but is restored during muscle regeneration.

In the embryo, skeletal muscle formation is constituted by two different phases: the first one includes an early myogenesis during the initial 14 days, subsequently, the following step is characterized by the proliferation and differentiation of myoblasts, determining the formation and maturation of muscle fiber types identity (Zhang and McLennan 1998). In fact, the final part of muscle differentiation process is regulated by the expression of Myosin Heavy Chain (MHC), which

is expressed in different isoforms depending on the muscle type (Weiss and Leinwand 1996). In adult, there are four different isoforms: MHC type I, or slow isoform and three fast MHC type IIb, IIa and IIc/x. According to these isoforms, it is possible to classify three types of skeletal muscle fibers: slow, fast and intermediate. The slow fibers express MHC type I, show small dimensions and are characterized by an oxidative metabolism. Physiologically, slow fibers exhibit slow speeds of contraction, but a high resistance to fatigue. On the other hand, fast fibers express the MHC type IIb and are predominantly characterized by glycolytic anaerobic metabolism. These fibers are able to contract very rapidly, producing intense muscular forces, but have a low resistance to fatigue. Finally, the intermediate fibers show contractile and metabolic characteristics in the middle to the previously described muscle fibers, and express MHC isoforms IIa and IIc/x (Talmadge et al. 1993).

The molecular mechanisms regulating slow versus fast fiber phenotypes were investigated (Buckingham 2001): slow fibers will revert to a fast phenotype on denervation. It has been demonstrated that NFAT transcription factor regulates the gene expression in slow fibers as a result of calcineurin-activated Ca^{2+} -dependent pathway (Olson and Williams 2000), moreover it has been proposed also MEF2 as another mediator of calcineurin signalling (Olson and Williams 2000).

Furthermore, slow fiber type identity depends on an E-box motif (O'Mahoney et al. 1998), which in the case of the slow Troponin1 gene binds a TFII-1 like factor (O'Mahoney et al. 1998). Finally, in order to mimic the effect of slow motor neurons on myosin gene expression, Ras signalling was found as another important actor for the activation of slow muscle specific genes.

2.2. ROLE OF SATELLITE CELLS IN MUSCLE REGENERATION

Satellite cells (SCs) are muscle stem cells, known as myogenic progenitors localized in a specific *niches*, suggesting the critical role of oxygen during muscle regeneration (Chaillou and Lanner 2016). *In vivo*, SCs respond to hypoxic, ischemic muscle damage by activation, proliferation, differentiation to myotubes, and maturation to muscle fibers, while maintaining their reserve pool of SCs (Koning et al. 2011). Therefore, the hypothesis is that hypoxia improves proliferation and differentiation of SCs (Koning et al. 2011). Skeletal muscle is a post-mitotic tissue that has a high regenerative potential (Almeida et al. 2016) and this feature is mainly due to SCs, highly heterogeneous cells population, which form a reservoir of precursor cells that are responsible for its after-birth growth and also for the response to injuries, either by exercise or by disease (Charge and Rudnicki 2004). Their amounts in the adult muscle could vary between 3 and 11% of the myonuclei, depending upon which species are being analyzed. In mice, the amount of SCs drops from 32% in neonates to 5% in adults (Allbrook et al. 1971) (Bischoff and Heintz 1994). These cells are strictly associated with the sarcolemma, residing between the membrane and the basal lamina (Mauro 1961),

becoming associated with the muscle fiber before the formation of its surrounding lamina (Bischoff and Heintz 1994). These cells are easily identified by their location and morphology; the transcription factor Pax7 is found to be the most important marker that characterizes this cell type (Seale and Rudnicki 2000). While it is clear that bovine satellite cells were shown to both proliferate and differentiate more efficiently under hypoxia (Kook et al. 2008), most is unknown for different species and cell types; in fact, for example, the influence of hypoxia on human satellite cells has not yet been fully investigated (Koning et al. 2011).

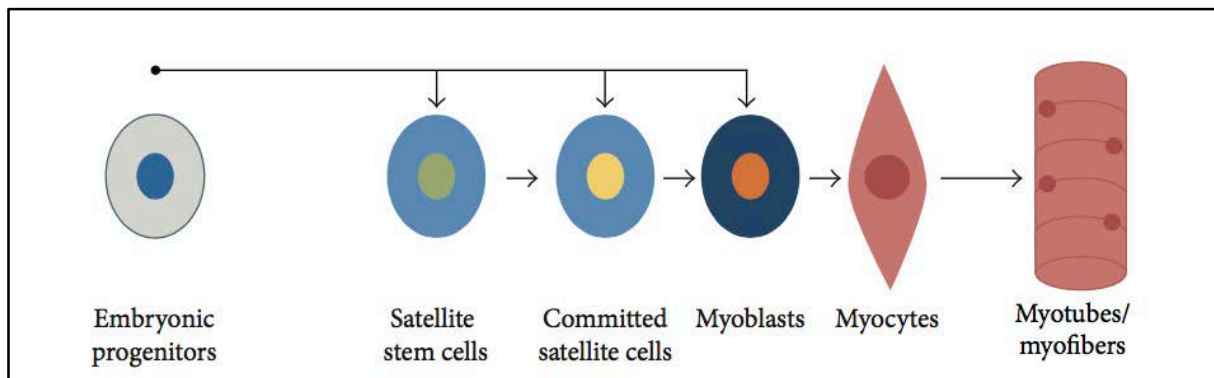

Figure 4. Schematic representation of myogenesis.

SCs have a pivotal role in adult muscle regeneration (Lepper and Fan 2010), and they are under the same genetic hierarchy involved in embryonic myogenesis, with the same genes participating in their regulation (Rudnicki et al. 2008). The major distinction between embryonic myogenesis and adult regeneration is that the latter requires a scaffolding that will work as a template (Ciciliot and Schiaffino 2010).

It is further known that, upon activation, specific SCs undergo asymmetric division, by which they could form cells that either are capable of self-renewing or can enter the myogenic pathway and differentiate to restore the muscle (Kuang et al. 2008).

3. EFFECTS OF HYPOXIA ON MYOGENESIS

3.1. EFFECT OF HIF-1 α ACTIVATION IN SKELETAL MUSCLE DIFFERENTIATION

It has been reported that transient hypoxia and prolonged hypoxia have different effects on muscle regeneration: while transient hypoxia is beneficial and stimulates productive proliferation and differentiation of satellite cells (SCs), on the other hand prolonged hypoxia is found to be detrimental, leading to the inhibition of differentiation process (Jash and Adhya 2015).

It has been demonstrated that myogenesis is blocked at low oxygen levels, inducing the degradation of MyoD, and the reduction of E2A and myogenin genes (Yun et al. 2005). It is well-known that skeletal muscle possesses the capacity to ride out chronic ischemia, which has been shown to induce skeletal muscle adaptations, including metabolic changes (Chaillou et al. 2014) and muscle atrophy (Favier et al. 2015). In fact, it has been demonstrated that muscle fibers, originated during chronic ischemia, have smaller diameters than healthy myofibers (Scholz et al. 2003). Along this line, also the exposure to high altitude result in the same phenotype (Howald and Hoppeler 2003). Taken together, these scenarios suggest that hypoxia is able to alter myogenesis.

Di Carlo et al. have reported that the induction of differentiation under prolonged hypoxia causes a marked degradation of MyoD (Di Carlo et al. 2004), leading to the inhibition of myotubes formation and a reduced expression of MHC (Di Carlo et al. 2004).

Furthermore, the proliferation and differentiation of C2C12 myoblasts has been studied during hypoxia by silencing HIF-1 α , which inhibits myotube formation and MHC expression (Ono et al. 2006), confirming the crucial role played by HIF-1 α . In contrast, other studies showed that hypoxia is detrimental for myogenic process, leading to the formation of smaller and poorly organized myofibers (Yun et al. 2005), concluding that hypoxia can alter the expression of key genes involved in myocyte fusion and myofiber growth.

It is noteworthy that myoblast differentiation is not irreversibly blocked by hypoxia. Indeed, myoblasts regain their capacity to proliferate and differentiate when normal oxygen levels are restored. Thus, although myogenesis is strongly inhibited at 0.5% O₂, overexpression of MyoD, or of myogenin alone restores myogenesis to a similar level to that in normoxia (Yun et al. 2005).

Tissue-specific knockout (KO) of HIF-1 α in muscle cells did not affect cell proliferation, but KO of HIF1 α in myeloid cells resulted in reduced macrophage infiltration and numbers of proliferating cells (Scheerer et al. 2013), suggesting that hypoxia indirectly triggers myoblast proliferation through phagocytic clearance of the debris at the injury site.

It has been recently demonstrated that Echinomycin, a molecule able to inhibit the binding between HIF-1 α to DNA (Vlaminck et al. 2007), also interferes with myogenic differentiation (Cirillo et al. 2017). These results were overlapping to those obtained by genetic inhibition of HIF-1 α , in fact the *in vitro* silencing of HIF-1 α strongly reduced the differentiation process, inducing a downregulation of MyoD nuclear translocation, a marked decrease of myogenin and MHC gene expression and ultimately leading to a reduction of fusion and differentiation indexes (Cirillo et al. 2017).

Moreover, the crucial role of HIF-1 α was also confirmed *in vivo*, in the regeneration of muscle tissue in mice after eccentric exercise (Ono et al. 2006).

Among the PHD isoforms, PHD2 has emerged as particularly critical. In mice, KO of PHD2, but not of PHD1 or PHD3, leads to embryonic lethality (Takeda et al. 2006). Therefore, it has been proposed a different model of conditional PHD2 KO (cKO), which presents an increase in haematocrit values, haemoglobin concentrations and capillary number in muscles, demonstrating the beneficial effects of the indirect activation of HIF pathway upon inhibition of PHD2 (Nunomiya et al. 2016).

At the same time, PHD2 deficiency resulted in an increased capillary density in skeletal muscles due to the induction of VEGF and moreover stabilized HIF-1 α induced by PHD2 cKO resulted in the transition of muscle fibers toward a slow fiber type via a calcineurin/NFATc1 signaling pathway (Shin et al. 2016).

Along this line, treatment with a well-known PHDs inhibitor such as DMOG shows a potential therapeutic use in promoting angiogenesis in ischemic diseases, and perhaps for improving muscle recovery after injury, exercise or training (Milkiewicz et al. 2004). *In vivo*, DMOG enhanced the transcription of HIF-regulated genes reducing ischaemic injury (Ogle et al. 2012). Further, DMOG improved maximal aerobic velocity and endurance in both sedentary and trained rats (Favier et al. 2016).

3.2. ROLE OF WNT-FAMILY PROTEINS IN MUSCLE DIFFERENTIATION

Many evolutionarily conserved pathways in vertebrate development converge on HIF. One such example is the canonical WNT/ β -catenin pathway, which is potentiated by HIF in neural stem cell niches (Sim and Johnson 2014).

WNTs are evolutionarily conserved secreted Cys-rich proteins, and in humans there are 19 genes that encode WNTs (Kikuchi et al. 2011). They bind different receptors and activate three different pathways which are classified as: a) canonical (β -catenin-dependent), involved in regulating cell proliferation and b) two non-canonical (β -catenin-independent) signalling pathways (Niehrs 2012).

Cytosolic β -catenin is the principal mediator of canonical WNT signaling. Usually, β -catenin is localized in cytosol and binds cytosolic protein complex containing Axin, the adenomatous polyposis coli gene product (APC), and glycogen synthase kinase-3 β (GSK-3 β). Axin and APC serve as scaffolding proteins that enable GSK-3 β to phosphorylate β -catenin (Liu et al. 2002), thereby targeting it for ubiquitination and subsequent degradation by the proteasome. In absence of WNT stimulation, the levels of cytosolic β -catenin protein are kept low. After the binding of a WNT ligand to its co-receptors Frizzled (Fz) and low-density lipoprotein (LDL) receptor-related protein

(LRP) 5/6, the Dishevelled (Dvl) protein is activated, leading to the inhibition of GSK-3 β -mediated phosphorylation of β -catenin. The stabilization of cytosolic β -catenin induces its translocation to the nucleus, where binds to the T cell factor (TCF)/lymphoid enhancer factor (LEF) transcription factors and activates its target genes (Logan and Nusse 2004).

β -catenin is also implicated in non-canonical (β -catenin-independent) signalling pathways, where it translocates to the cell membrane compartment, and reversibly binds cadherins to α -catenin and to the actin cytoskeleton to form adherens junctions, which are essential for cell–cell adhesion and cell migration (Brembeck et al. 2006).

The non-canonical WNT pathways are subclassified according to the WNT receptors or co-receptors they are coupled to.

The best-characterized β -catenin-independent pathway is the PCP pathway, in which Frizzled receptors activate the small GTPases RAC1 and RHOA and JUN-N-terminal kinase (JNK), ultimately leading to rearrangements in cytoskeleton and cell polarity (Schlessinger et al. 2009). PCP and β -catenin-dependent WNT signalling are well known to antagonize each other, at the ligand–receptor level. For example, WNT5A, which preferentially activates PCP signalling, competes for and inhibits binding of WNT3A to Frizzled (Janda et al. 2012), thereby suppressing the β -catenin-dependent pathway (Sato et al. 2010).

The second β -catenin-independent pathway that has been described is the WNT- Ca^{2+} pathway (Kikuchi et al. 2011), which involves the activation of heterotrimeric G proteins, which in turn activate phospholipase C (PLC), finally stimulating diacyl-glycerol and inositol-1,4,5-trisphosphate (Ins(1,4,5)P3) production. Ins(1,4,5)P3 triggers Ca^{2+} release from intracellular stores and activation of effectors such as Ca^{2+} - and calmodulin-dependent kinase II (CAMKII), calcineurin and protein kinase C (PKC), which activates the transcriptional regulator nuclear factor associated with T cells (NFAT). This pathway is involved in cancer, inflammation and neurodegeneration (De 2011).

Noteworthy, the non canonical activation of WNT pathway involves WNT4, which regulates the subcellular localization of β -catenin, from cytosol to the cell membrane, switching to membrane functions of β -catenin (Bernard et al. 2008).

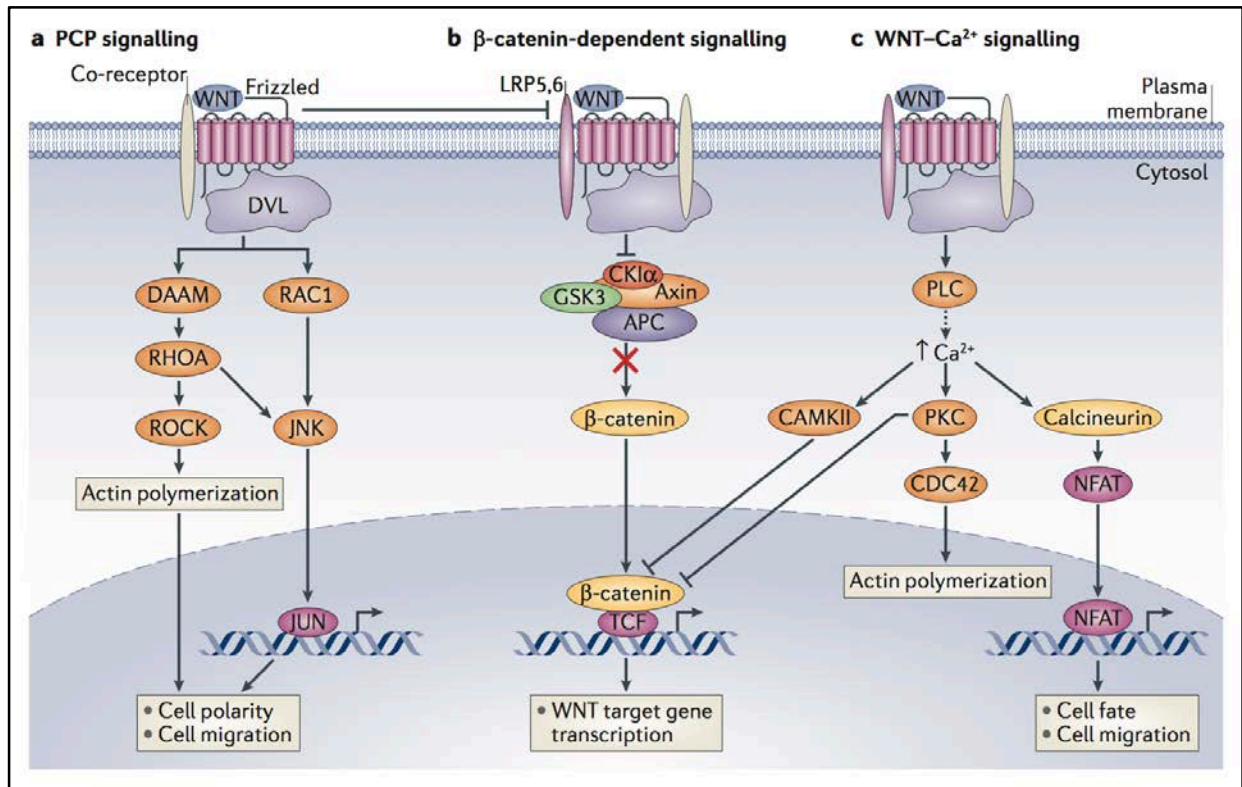

Figure 5. WNT signalling pathways. Only the three best-characterized WNT pathways are shown: A) the PCP pathway, B) the β -catenin-dependent pathway; C) the WNT- Ca^{2+} pathway. DAAM, DVL-associated activator of morphogenesis 1; DVL, Dishevelled; LRP, low-density lipoprotein receptor-related protein; PLC, phospholipase C. (Niehrs 2012)

Yuen et al. first showed the link between HIF and WNTs, demonstrating that WNT7a/7b expression is controlled by novel upstream hypoxia response elements (Yuen et al. 2014).

It is noteworthy that signals originated from axial structures (neural tube and notochord) and dorsal ectoderm activate myogenesis in newly formed somites. In mouse embryos, axial structures preferentially activate myogenesis through a Myf5-dependent pathway, while dorsal ectoderm through a MyoD-dependent pathway. In avian embryos, this activation is mediated by the simultaneous stimuli originated by Sonic Hedgehog (SHH) and WNT family (Munsterberg et al. 1995). The Hedgehog pathway is constituted by three mammalian Hedgehogs (Hh), Sonic, Indian, and Desert hedgehog (Shh, Ihh, and Dhh), which are essential for tissue growth, patterning, and morphogenesis (Ingham and McMahon 2001). It was suggested that SHH may induce activation of myogenic genes in response to WNT1, WNT3 and WNT4. Along this line, it has been reported that cells expressing WNT1 will preferentially activate Myf5, while cells expressing WNT7a will preferentially activate MyoD (Tajbakhsh et al. 1998). Further studies demonstrated that an overexpression of WNT4 resulted in up-regulation of muscle satellite cell markers Pax7 and MyoD. Thus, WNT4 acted as a stimulator during myogenic proliferation and differentiation (Takata et al. 2007). It has been evaluated the myogenic differentiation induced by WNT family members:

Troponin T expression was significantly increased with WNT6, WNT7a and WNT9a overexpression, but not WNT3a, WNT5a and WNT10a (Tanaka et al. 2011) according to the classification of WNTs into canonical or noncanonical WNTs, where WNT1, WNT3a, or WNT8 were considered to activate canonical WNT signaling, whereas WNT5a or WNT11 are best known for their ability to trigger noncanonical WNT signaling (Rao and Kuhl 2010).

A truncated WNT7a retains full biological activity in skeletal muscle and induces hypertrophy in differentiated myotubes and myofibers, opening important new avenues for the development of a WNT7a-based biologic drug for the treatment of muscle-wasting disease (von Maltzahn et al. 2013). Taken together, these discoveries suggested that different WNT molecules control cell proliferation and differentiation (Tanaka et al. 2011): the canonical WNT1, WNT3a, WNT8 and WNT10a trigger proliferation processes, whereas non canonical WNT4, WNT5a, WNT6, WNT7a, WNT9a and WNT11 are principally involved in differentiation mechanisms.

It has been demonstrated that specific phases of skeletal muscle development require different WNT members (Shi and Garry 2006). In particular, WNT1 and WNT3a are expressed during differentiation in dorsal and medial somites (Tajbakhsh et al. 1998); WNT3a overexpression significantly decreases terminally differentiated myogenic cells (Anakwe et al. 2003); WNT5a and WNT11 have been implicated in the switching of fast and/or slow myofiber types (Anakwe et al. 2003).

4. AIM

Hypoxic and ischemic preconditioning was initially discovered as an endogenous protective mechanism in animals and later confirmed in virtually all types of cultured cells and organs (Kirino 2002). It was demonstrated that intermitted cycles of hypoxia or ischemia enhance the resistance of subjects exposed to severe and prolonged ischemic events (Verges et al. 2015). During this preconditioning, there are two different phases of cytoprotection: a) *Phase I*, an acute protection that appears early and lasts for a few hours after insult and b) *Phase II*, a delayed but stronger protection which emerges many hours after hypoxia and can last for days or even weeks (Pong 2004). The delayed phase of this process is usually mediated by synthesis of mRNAs and proteins, including the transcription factor HIF-1 α and HIF target genes, such as erythropoietin (EPO) and vascular endothelial growth factor (VEGF).

As extensively described at the beginning of this thesis, HIF-1 α is well-known as the principal actor in the adaptive response to hypoxia, and is finely regulated by HIF prolyl hydroxylases (PHDs), which hydroxylate proline residues in its oxygen degradation domain (ODD) leading to its ultimate proteasomal degradation. The effects of the activation of HIF-1 α in pathological conditions have been extensively investigated, while its role in cell differentiation is still poorly understood. Regeneration of skeletal muscle is a complex process that requires the activation of quiescent adult stem cells, called satellite cells, which are resident in hypoxic niches in the tissue. To govern this process, cells have developed a complex machinery, which is mainly regulated by a group of transcription factors known as the hypoxia-inducible factors (HIFs).

For instance, HIF-1 α activation has been described as beneficial for the cell to overcome a hypoxic stress, as it enhances the transcription of glucose transporters and glycolytic enzymes, promotes the synthesis of the vascular endothelial growth factor (VEGF), and stimulates the inducible nitric oxide synthase. However, a chronic activation of HIF-1 α has been described as a negative predictor, completely inhibiting myogenesis. Indeed, upon an ischemic injury, it is known that the regeneration process can take place only after restoration of blood flow and tissue oxygenation. Therefore, oxygen deprivation and HIF-1 α may play a role in activating the initial steps of the regeneration process.

On these bases, we investigated the effects of a hypoxic pre-conditioning on the differentiation process. Moreover, we tried to chemically activate HIF-1 α using synthetic PHDs inhibitors, in order to mimic the effects observed under hypoxic conditions on myogenesis.

Finally, a future perspective could be to translate the use of these PHDs inhibitors from the *in vitro* experiments to *in vivo* models, in order to investigate their potential in the treatment of several atrophic muscle disorders and to improve the differentiation of muscle tissues.

MATERIALS AND METHODS

1. CELL CULTURES

C2C12 mouse myoblasts were obtained from Sigma-Aldrich and cultured in Dulbecco's modified Eagle's medium (DMEM, Sigma-Aldrich) with high glucose (4.5 g/L) supplemented with 10% (v/v) fetal bovine serum (FBS, Sigma-Aldrich), 2 mM glutamine (Sigma-Aldrich), penicillin/streptomycin 1X (Euroclone) (GM) at 37°C in a 5% CO₂ and 95% air-humidified atmosphere.

1.1. CELL PROLIFERATION

A) HYPOXIC PRE-CONDITIONING

For hypoxia experiments, cells were cultured at 37°C in a 5% CO₂/1% O₂ incubator with a nitrogen inlet at different time lengths. To assay cell proliferation, growth curves were performed counting cells after Trypan Blue staining. Briefly, 75*10³ C2C12 cells were seeded in 35mm culture plates, and viable cells were counted after 3, 6, 12, 24 and 48 hours of hypoxia and/or normoxia treatments. For the hypoxic pre-conditioning, C2C12 myoblasts were cultured for 24 hours in an incubator with a nitrogen inlet at 1% O₂, 5% CO₂, and 37°C.

B) SKELETAL MUSCLE DIFFERENTIATION

To induce differentiation, C2C12 cells were switched to a normoxic incubator (21% O₂) in the differentiation medium (DM) containing DMEM supplemented with 2% (v/v) horse serum (HS, Sigma-Aldrich). The DM was changed every day for seven days. Cells were collected for analyses after 24 hours of hypoxia treatment (Post Treatment, PT) and at day 3, 5 and 7 of differentiation.

C) HIF-1 α SILENCING

The genetic silencing of HIF-1 α in C2C12 cells was achieved by transfecting with HIF-1 α siRNA (Santa Cruz), according to the Manufacturer's instructions. Briefly, 2 μ g of HIF-1 α and control plasmid were used to transfect C2C12 in the presence of Viafect Transfection Reagent (Promega) according to the Manufacturer's procedure. Silenced clones were isolated after selection with Puromycin (1.2 μ g/ml).

In parallel, the chemical inhibition of HIF-1 α was obtained by treating cells with 5nM Echinomycin, a HIF-1 α inhibitor which prevents its binding to DNA, for 24 hours under normoxic or hypoxic conditions.

D) WNTs CHEMICAL INHIBITION

In order to inhibit the WNT signaling pathway, C2C12 were cultured for 24 hours under hypoxic conditions in the presence of 40 μ M XAV939 (Sigma), which promotes the accumulation of Axin2, leading to the phosphorylation and degradation of β -catenin.

E) PHDs INHIBITORS PRE-TREATMENT

For the chemical inhibition of PHDs, cells were cultured for 24 hours with PHDs inhibitors (50 μ M IOX2 and 40 μ M FG-4592) at 37°C in 5% CO₂, and then induced to differentiate, switching in differentiation medium (DM), containing DMEM supplemented with 2% (v/v) horse serum (HS, Sigma-Aldrich). The DM was changed every day for seven days. Cells were collected for analyses after 24 hours of inhibitors treatment (PT) and at 3, 5 and 7 days of differentiation.

1.2. CELL VIABILITY AND CELLULAR METABOLISM

Cell viability after treatment with PHDs inhibitors was assessed using RealTime-Glo™ kits MT Cell Viability Assay (Promega). The RealTime-Glo™ Cell Viability Assay is a nonlytic, homogeneous, bioluminescent method to measure cell viability in real time using a simple, plate-based method. The nonlytic nature of this assay allows the cells to be used for further downstream applications, including multiplexing with a variety of assay chemistries. It determines the number of viable cells in culture by measuring the reducing potential of cells and thus metabolism (MT). The assay involves adding NanoLuc® luciferase and a cell-permeant prosubstrate, the MT Cell Viability Substrate, to cells in culture. Viable cells reduce the proprietary prosubstrate to generate a substrate for NanoLuc® luciferase. This substrate diffuses from cells into the surrounding culture medium, where it is rapidly used by the NanoLuc® Enzyme to produce a luminescent signal. The signal correlates with the number of viable cells, making the assay well suited for cytotoxicity studies. Both the MT Cell Viability Substrate and NanoLuc® Enzyme are stable in complete cell culture medium at 37°C for at least 72 hours. No cell washing, removal of medium or further reagent addition is required to determine the number of viable cells.

For the optimization, C2C12 were seeded at 5 different cell density: 7500 cells/well, 5000 cells/well, 2500 cells/well, 1000 cells/well, 500 cells/well in 96-well following manufacturer's instructions. The luminescent signal was measured at 1, 3, 6, 12, 24 and 48 hours using VICTOR X3™ Multilabel Plate Reader. Briefly, MT Cell Viability Substrate and NanoLuc® Enzyme are both diluted 1:1000 in culture medium at a final volume of 100 μ l per well. For the following experiments, cells were seeded at a density of 5000 cells/well in 96-well. After 24 hours, cells are treated in the presence of the chemical inhibitors. Cell viability was measured at 3, 6, 12, 24 and 48 hours. Data were normalized to the untreated control.

1.3. CELL TOXICITY TESTS

CellTox™ Cytotoxicity Assay (Promega) was used to investigate the cytotoxic effect of hypoxia on C2C12 cells, according to the Manufacturer's instructions. The CellTox™ Green Cytotoxicity Assay measures changes in membrane integrity that occur as a result of cell death. The assay is intended for assessing cytotoxicity in cell culture after experimental manipulation. The assay system uses a proprietary asymmetric cyanine dye that is excluded from viable cells but preferentially stains the dead cells' DNA. When the dye binds DNA in compromised cells, the dye's fluorescent properties are substantially enhanced. Viable cells produce no appreciable increases in fluorescence. Therefore, the fluorescent signal produced by the dye binding to the dead-cell DNA is proportional to cytotoxicity.

Briefly, C2C12 cells were seeded in a 96-well plate at a concentration of 5000 cells/well and incubated for 3, 6, 12, 24, and 48 hours. After each incubation, an equal volume of 100 µl of CellTox Buffer containing 1:500 dilution CellTox Green Dye was added to each well and incubated at room temperature for 15 minutes. The signal was measured using the VICTOR™ X3 Multilabel Plate Reader with an excitation wavelength of 485-500 nm and emission filter of 520-530 nm.

2. LUCIFERASE ASSAY

IC50 was calculated using a Dual-Glo® Luciferase Assay System kit (Promega), which measures the activity of PHDs in presence of the inhibitors, IOX2 and FG-4592, at different concentrations.

Dual-Glo® Luciferase Assay allows an high-throughput analysis of mammalian cells containing the reporter genes Firefly Luciferase (Luciferase-pcDNA3, ODD-Luciferase-pcDNA3) and Renilla luciferase (pRL-CMV). The Dual-Glo® Luciferase Assay System can be added directly to cells in growth medium without washing or preconditioning. This reagent induces cell lysis and acts as a substrate for firefly luciferase. Addition of the Dual-Glo® Stop & Glo® Reagent quenches the luminescence from the firefly reaction by at least 10,000-fold and provides the substrate for Renilla luciferase in a reaction that can also be read within 2 hours (with a similar retention in signal).

In particular, cells were seeded in a 96-well plate at a concentration of 10^4 cells/well, transfected with an ODD-luciferase-pcDNA3 or Empty-luciferase-pcDNA3 (80 ng) and pRL-CMV (8 ng) as internal control, according to ViaFect Transfection Reagent® protocol (Promega) and incubated for 24 hours. After the transfection, cells were treated with PHDs inhibitors for 3, 6, 12, 24, and 48 hours.

At the end of the treatment, an equal volume of Dual-Glo® Luciferase Reagent to the volume of resuspension of the cells was added to each well and the mixture was incubated for 30 minutes. At

the end of the incubation the solution was transferred to 96-well white plates for luminescence reading emitted at 550 nm by Firefly luciferase, the signal was measured using VICTOR™ X3 Multilabel Plate Reader. To turn off the luminescence of the Firefly luciferase and provide the substrate for the Renilla luciferase was added an equal volume of Dual-Glo® Stop & Glo reagent. After 30 minutes, the signal emitted by Renilla at 480 nm was read by VICTOR™ X3 Multilabel Plate Reader. The calculation of IC50 was performed by linear regression, using GraphPad Prism 7 (GraphPad Software Inc, California, USA).

3. WNT7a-PROMOTER PLASMID CONSTRUCT

The promoter of WNT7a gene was amplified by PCR using Phusion High-Fidelity kit (NEB) from 100 ng of genomic DNA obtained by C2C12 murine myoblasts. In order to amplify the fragment the following primers were used: forward 5'-GGGGTACCCCGGAAGCTATCACAGGCTT-3', which contained KpnI enzymatic site, and reverse 5'-GGGTTCGAACCCTAGCATCCTTCGCTAACT-3', which contained the HindIII enzymatic site. The PCR fragment and the vector pNL1.1(Nluc) (Promega) were digested in presence of the restriction enzymes KpnI and HindIII (Promega) for 2 hours at 37°C. Both were purified from agarose gel using Wizard® SV Gel and PCR Clean-Up System (Promega) and the fragment was cloned into the corresponding site of the vector pNL1.1 using T4 Ligase Fast (Promega) for 1 hour at room temperature.

4. NANO-GLO LUCIFERASE ASSAY

The direct interaction between WNT7a promoter and HIF-1 α was evaluated with Nano-Glo® Dual-Luciferase Assay System kit (Promega), which allows a high-throughput analysis of mammalian cells containing the reporter genes Nanoluc (pNL1.1empty and pNL1.1WNT7a_promoter) and pGL4.54(luc2/TK), as internal control. Briefly, cells were seeded in a 96-well plate at a concentration of 5×10^3 cells per well, transfected with a pNL1.1empty or pNL1.1WNT7a_promoter (90 ng) and pGL4.54(luc/TK) (10 ng) as internal control, according to ViaFect Transfection Reagent® protocol (Promega) and incubated for 24 hours. After the transfection, cells were treated with IOX2 and FG-4592 at the IC50 working concentrations for 24 hours. At the end of the treatment, an equal volume of ONE-Glo™ EX Luciferase Assay Reagent was added to each well and incubated for 30 minutes. At the end of the incubation the signal was measured using VICTOR™ X3 Multilabel Plate Reader (PerkinElmer, Waltham, MA, USA). To turn off the luminescence of the Firefly luciferase and provide the substrate for the Nanoluc, NanoDLR™

Stop&Glo® Reagent was added to the mixture and incubated for 30 minutes. At the end of incubation, the signal was read, as described above, using VICTOR™ X3 Multilabel Plate Reader (PerkinElmer, Waltham, MA, USA).

5. RNA EXTRACTION AND GENE EXPRESSION BY REAL-TIME PCR (qPCR)

Total RNA was isolated using ReliaPrep™ RNA Miniprep Systems (Promega) and 1 µg of the extracted RNA was reverse transcribed to cDNA using the iScript cDNA synthesis kit (BioRad), according to the Manufacturer's instructions. Real-Time PCR was performed with 10 ng of cDNA template, 0.2 µM primers, and 1X Power SYBR Green PCR Master Mix (Thermo Fisher Scientific) in 20 µl final volume using a StepOnePlus® Real-Time PCR System (Applied Biosystem).

The following primers were used: VEGF forward 5'-AAAAACGAAAGCGCA-3' and reverse 5'-TTTCTCCGCTCTGAA-3'; PHD2 forward 5'-CTGTGGAACAGCCCTTTTT-3' and reverse 5'-CGAGTCTCTCTGCGAATCCT-3'; PHD3 forward 5'-CTATGTCAAGGAGCGGTGCAA-3' and reverse 5'-GTCCACATGGCGAACATAACC-3'; MYOG forward 5'-AGCCACACTGAGGGA-3' and reverse 5'-GTTGAGGGAGCTGAG-3'; MHC forward 5'-TGGAGCAGGAGGAATAACAAG-3' and reverse 5'-GCATAGTGGATGAGGGAGAA-3'; WNT7a forward 5'-ACTGTGGCTGCGACAAG-3' and reverse 5'-CTTCATGTTCTCCTCCAG-3'; WNT9a forward 5'-TCGTGGGTGTGAAGGTGATA-3' and reverse 5'-CAGGAGCCAGACACACCAT-3'; WNT4 forward 5'-GGGTGGAGTGCAAGTGTC-3' and reverse 5'-CACGCCAGCACGTCTTTAC-3'; ID1 forward 5'-GAGTCTGAAGTCGGGACCAC-3' and reverse 5'-ATCGTCGGGTGGAACACATG-3'; MYOR forward 5'-GCCCAGCGACATTTCTTC-3' and reverse 5'-CGCTTCCTCTTGCATCCT-3'; TCF7 forward 5'-TGATGCTGGGATCTGGTGTA-3' and reverse 5'-CTTGGGTCTGCCTGTGTTT-3'; CYCLIN D1 forward 5'-TTGACTGCCGAGAAGTTGTG-3' and reverse 5'-CTGGCATTTTGGAGAGGAAG-3'; GLUT1 forward 5'-GACCCTGCACCTCATTGG and reverse 5'-GATGCTCAGATAGGACATCCAAG-3'; HK1 5'-GTGGACGGGACGCTCTAC-3' and reverse 5'-CCACCATCTCCACGTTCTTC-3'; GAPDH forward 5'-CGTGCCGCTGGAGAAAC-3' and reverse 5'-TGGGAGTTGCTGTTGAAGTCG-3'; RPL13A forward 5'-CTCGGCCGTTCTGTAT-3' and reverse 5'-GTGGAAGTGGGGCTTCAGTA-3', this latter was used as the housekeeping gene. The amplification program consisted in an initial denaturation at 95°C for 3 minutes, followed by 40 cycles of 5 seconds each at 95°C and 30 seconds at 57°C; WNT7a was amplified at 53°C. Relative quantification of target genes was performed in triplicate and calculated by the equation $2^{-\Delta\Delta Ct}$.

6. ISOLATION OF THE PLASMA MEMBRANES AND THE NUCLEI COMPARTMENT

For plasma membranes isolation, C2C12 were harvested by scraping, centrifuged at 300xg for 5 minutes, and resuspended in a phosphate-buffer saline (PBS) solution containing protease-inhibitor and phosphatase-inhibitor cocktails (Sigma-Aldrich). Then, cells were lysed by sonication and centrifuged at 800xg for 10 minutes at 4°C, to eliminate intact cells and nuclear components. The crude extract was centrifuged at 200,000xg for 20 minutes at 4°C with a TLC100 Ultracentrifuge (Beckman Coulter) to obtain the cytosolic and plasma membrane fractions.

For nuclei separation, 5×10^6 cells were collected after enzymatic treatment with trypsin (Sigma-Aldrich), centrifuged at the maximum speed, resuspended in 400 µl of Buffer A (10 mM KCl, 0.1 mM EDTA, 1mM DTT, 10 mM Hepes, pH 7.9), containing protease and phosphatase inhibitors cocktail (Sigma-Aldrich), and incubated on ice for 20 minutes. Then, NP40 10% was added to the cell suspension, mixed for 40 seconds and centrifuged 40 seconds at the maximum speed. After centrifugation, the pellet was resuspended in 80 µl of Buffer C (0.4M NaCl, 1mM EDTA, 1 mM DTT, 20 mM Hepes, pH 7.9), containing a protease and phosphatase inhibitors cocktail and it was mixed for 30 minutes at 4°C at the maximum speed. Finally, the nuclear suspension was centrifuged for 5 minutes at 4°C at the maximum speed, collected and transferred in a new tube. Total protein content was determined with the BCA Protein Assay Kit (Pierce) following the Manufacturer's instructions.

7. WESTERN BLOT ANALYSES

Proteins were denatured by boiling for 10 minutes in sample buffer (0.6 g/100 mL Tris, 2 g/100 mL SDS, 10% glycerol, 1% b-mercaptoethanol, pH 6.8) and loaded into 10% SDS-PAGE gel, then transferred onto a nitrocellulose membrane (Trans-blot, Bio-Rad Laboratories) by electroblotting. Nitrocellulose membranes were incubated with a blocking solution containing 5% (w/v) non-fat dry milk or 5% (w/v) BSA (Sigma-Aldrich) in Tris-buffer saline with 0.1% Tween® 20 (TBS-T) for 1 hour. Blots were incubated with primary antibodies for 2 hours at room temperature. The following primary antibodies were used: anti-β-catenin, 1:1000 dilution (Cell Signaling), anti- Na^+/K^+ ATPase, 1:1000 dilution (Cell Signaling), anti-HIF-1α, 1:1000 dilution (Cell Signaling, clone D2U3T), anti-Lamin A/C, 1:1000 dilution (Santa Cruz Biotechnology, clone N-18), anti-MyoD1, 1:1000 dilution (Abcam, clone 5.2F), anti-Lamin β1, 1:1000 (Abcam, clone 119D5-F1), anti-WNT7a, 1:1000 dilution (Thermo Fisher Scientific). Membranes were washed three times for 10 minutes with TBS-T, and then incubated with the appropriate anti-mouse, anti-rabbit or anti-goat HRP-conjugated

secondary antibodies (Dako), 1:2000 dilution, for 1 hour at room temperature. After three washes for 10 minutes with TBS-T, the immunoreactive bands were visualized using the enhanced chemiluminescence detection kit reagents (ECL Advance, GeHealthcare), following the Manufacturer's instructions.

8. IMMUNOFLUORESCENCE STAINING

C2C12 cells were plated onto 35mm culture plates. After differentiation, cells were washed in PBS and fixed for 15 minutes in 4% (w/v) paraformaldehyde at room temperature. For permeabilization and blocking, cells were incubated for 1 hour in the presence of PBS 0.1% (v/v) Triton X-100 (TX-100) and 5% (w/v) fetal bovine serum (FBS) at room temperature. Then, cells were incubated for 2 hours at room temperature with anti-Skeletal, Fast, Myosin (Sigma-Aldrich, clone MY-32), diluted 1:200 in PBS 0.1% (v/v) Triton X-100 (TX-100) and 5% (w/v) FBS. After incubation, cells were washed three times in PBS and incubated for 1 hour at room temperature with anti-mouse FITC-conjugated secondary antibody (Jackson ImmunoResearch), diluted 1:200. After washing in PBS, cells were analyzed under a fluorescent microscope (Olympus TH4-200) equipped with an acquisition camera, the original magnification was 100X. Cell nuclei were counterstained with Hoechst 33258 (1:500 dilution). Myogenesis was assessed by measuring the myotube area and the number of myonuclei per myotube. To quantify both differentiation and fusion indexes, ten fields were chosen randomly and, for each field, a minimum of one hundred myosin-positive myotubes with more than two myonuclei were measured using the Image J software. The area and the number of nuclei per myotube was the mean of ten measurements averaged from three different experiments. In detail, the fusion index is calculated as the ratio between MHC-positive nuclei and the total number of nuclei, while the differentiation index as the ratio between the average of myotubes area and nuclei localized in the MHC-positive myotubes.

9. CHROMATIN IMMUNOPRECIPITATION (CHIP)

Chromatin immunoprecipitation assay (ChIP) was conducted in mouse myoblasts C2C12 after 24 hours exposure to normoxic or hypoxic (1% O₂) conditions. ChIP assay was performed using a SimpleChIP® Enzymatic Chromatin IP Kit (Magnetic Beads, Cell Signaling) according to the manufacturer's protocol.

The ChIP assay is a powerful and versatile technique used for probing protein-DNA interactions within the natural chromatin context of the cell. This assay can be used to identify multiple proteins associated with a specific region of the genome, or the opposite, to identify the many regions of the

genome associated with a particular protein. We evaluated the regulation of HIF-1 α on the Wnt7a promoter.

When performing the ChIP assay, cells are first fixed with formaldehyde, a reversible protein-DNA cross-linking agent that serves to fix or “preserve” the protein-DNA interactions occurring in the cell. Cells are then lysed and chromatin is harvested and fragmented using either sonication or enzymatic digestion. The chromatin is then subjected to immunoprecipitation using antibodies specific to a particular protein. Any DNA sequences that are associated with the protein of interest will co-precipitate as part of the cross-linked chromatin complex and the relative amount of that DNA sequence will be enriched by the immunoselection process. After immunoprecipitation, the protein-DNA cross-links are reversed and the DNA is purified. The enrichment of a particular DNA sequence or sequences can then be detected by qPCR.

Briefly, genomic DNA was cross-linked with bound proteins with 1% formaldehyde (for 10 minutes at room temperature). Genomic DNA was digested with Micrococcal Nuclease for 20 minutes at 37°C to achieve DNA sizes ranging from 150 to 900 bp. The nuclear pellet was lysed by sonication (Branson Sonifier 150).

For the immunoprecipitation of DNA-protein mix, 10 μ l of anti-HIF-1 α (Cell Signaling), or 10 μ l of anti-Histone-H3 (positive control), or 1 μ l of IgG rabbit (negative control) were added to the chromatin solution and incubated at 4°C over-night with rotation. Immuno-complexes were collected with ChIP Grade Protein G Magnetic Beads and incubated for 2 hours at 4°C with rotation. The elutes were finally digested with Proteinase K at 65°C for 4 hours. The precipitates DNAs were recovered using DNA Purification Spin Columns. The purified DNA was amplified by Real-Time PCR using these following ChIP primers designed on WNT7a promoter: WNT7a1 forward 5'-CTATCACAGGCTTGCCCAGA-3' and reverse 5'-ACCGTGGATTCAAGGAACAC-3'; WNT7a2 forward 5'-CAGGCTGTACCCAGACCAAG-3' and reverse 5'-ACTCCAGGCCTGCTTAGCC-3'; WNT7a3 forward 5'-GCAGTCTGGAAGGCTAAGCA-3' and reverse 5'-GCAGCCCAAGTTTCAGTTG-3'; WNT7a4 forward 5'-TTCACCTCCTCAGTTTCTCCA-3' and reverse 5'-AGCCCAATGACCAGTAGCAG-3'; WNT7a5 forward 5'-AAGACAAAAGGCCAGAATGC-3' and reverse 5'-GACAGGATCCTCCGGAATCT-3'; WNT7a6 forward 5'-GTCTCGCCTTAGGTGCAATC-3' and reverse 5'-GGCTCATTTTCAGAACCCTCA-3'; WNT7a7 forward 5'-GCACAGACGAGGGTGAGG-3' and reverse 5'-GGCCATCCTCTGGGTGTAG-3'.

10. STATISTICAL ANALYSIS

For all quantified data, mean \pm SEM values are presented. The Student's *t*-test was used to determine significance using Graphpad Prism 6 Software. *P* values of less than 0.05 were considered to be significant. All *P* values were calculated from data obtained from at least three independent experiments. All error bars represent the standard deviation of the mean.

All the results are expressed as Relative Quantity (R.Q.), which allows to measure differences in the expression level of a specific target gene or protein between different samples. This method requires an initial phase where the results of the target gene/protein are normalized using an housekeeper as internal control, which is a gene/protein not modified by the treatment and constitutively expressed by cells. After the normalization, the results are expressed as fold increase or decrease in comparison to a reference sample control (CTRL=1), which is the untreated sample. The same method was applied to the gene or protein experiments.

RESULTS

1. PROLIFERATION AND CELL TOXICITY ASSAYS

The effects of a hypoxic pre-conditioning on skeletal muscle differentiation were studied on C2C12 murine myoblasts. Initially, we tested the effects of oxygen deprivation on the proliferation rate. To this purpose, myoblasts were cultured in a hypoxic incubator at 1% O₂ for 3, 6, 12, 24 and 48 hours to assess the toxicity of the treatment. Control myoblasts were cultured under normoxia (21% O₂). During the first 12 hours, no significant changes in the proliferation rate were observed, whereas after 24 hours of hypoxic pre-conditioning, cells showed a marked decrease in proliferation rate (-50%) which reached -70% at 48 hours (**Figure 1A**). Then, cytotoxicity was measured using CellTox™ (Promega) assay, which measures changes in membrane integrity that occur as a result of cell death, using a cyanine dye that penetrates the cell and binds to the DNA of compromised cells. Results showed that the hypoxic pre-conditioning did not induce any evident cytotoxic effect within the first 24 hours, while at 48 hours, myoblasts cultured in 1% O₂ showed a 3.6-fold increase in the fluorescence signal as compared to controls (**Figure 1B**).

2. ACTIVATION OF HIF-1 α PATHWAY UNDER HYPOXIA

Based on the cytotoxicity tests, a 24 hours hypoxic pre-conditioning (1% O₂) was chosen for the following studies, considering that the decrease of proliferation rate observed at 24 hours was not due to cytotoxic effect. Initially, it was tested whether a hypoxic pre-conditioning activated the HIF-1 α pathway. To this purpose, HIF-1 α translocation to the nucleus was analyzed by Western Blot (WB), after nuclei isolation. Results showed a protein band of 100 kDa corresponding to a 1.5-fold increase in HIF-1 α nuclear localization in hypoxia pre-conditioned myoblasts as compared to normoxic controls (**Figure 1C**), while a negligible amount of protein was found in the cytosolic fraction (data not shown). Lamin A/C protein, which is a nuclear marker, was used as the housekeeper. Quantitative PCR (qPCR) analyses of key HIF-1 α target genes revealed a 2.5-, 5.1- and 6.6-fold increase in the mRNAs of VEGF, PHD2 and PHD3, respectively, after a 24 hours hypoxic pre-conditioning, as compared to normoxic controls (**Figure 1D**).

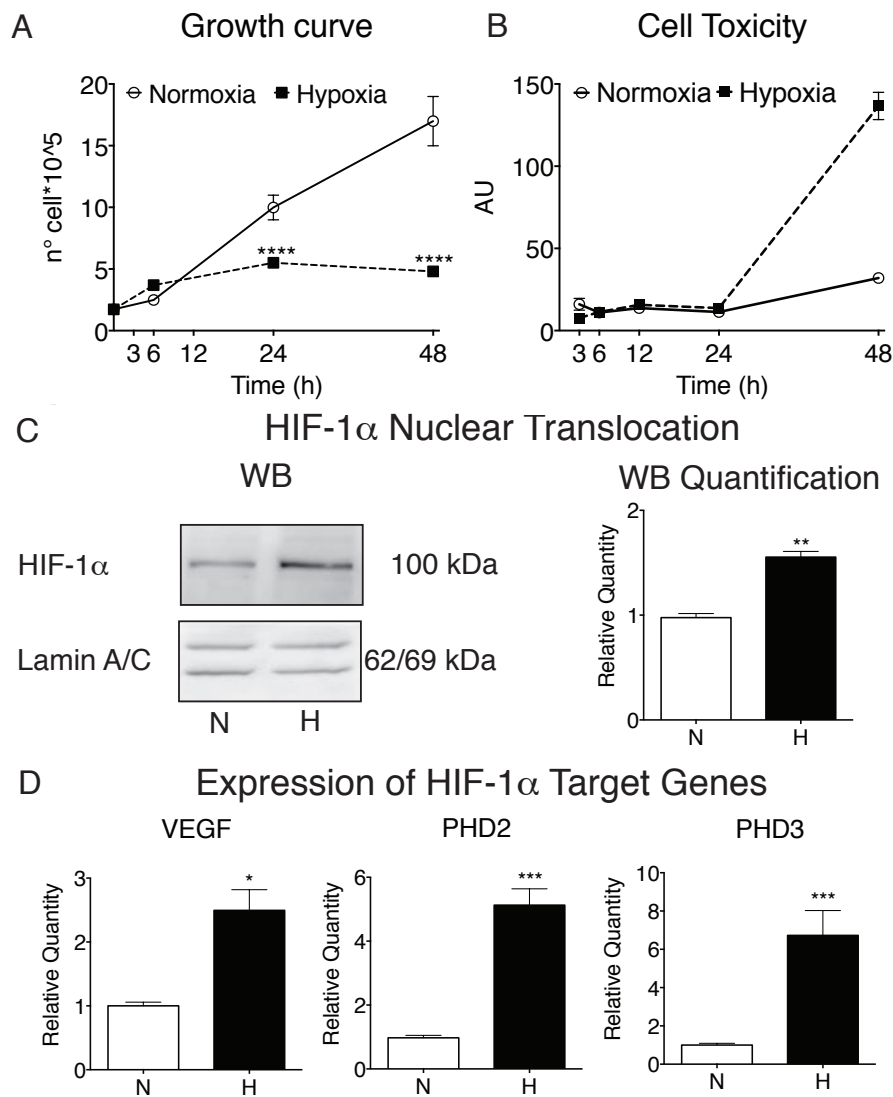

Figure 1. Effects of hypoxia on C2C12 murine myoblasts on cell proliferation, toxicity, and activation of HIF-1 α . The effects of hypoxia were evaluated analyzing the cell growth curve (A) and toxicity (B) of C2C12 cells cultured in normoxia (N) or in hypoxia (H) for 3, 6, 12, 24, and 48 hours. Western blot (WB) and the relative quantification of HIF-1 α nuclear translocation were performed after nuclei separation from cells treated for 24 hours in normoxic or hypoxic conditions, while a negligible amount of protein was found in the cytosolic fraction (data not shown). Lamin A/C was used as nuclear marker (C). Activation of the HIF-1 α pathway was measured by qPCR analyzing the expression of its target genes: VEGF, PHD2, and PHD3 (D). Data represent mean \pm SEM of 4 independent experiments. Statistical significance was determined by Student's t test. *P < 0.05; **P < 0.01; ***P < 0.001; ****P < 0.0001.

3. EFFECTS OF HYPOXIA ON MYOGENESIS

To assess whether a hypoxic pre-treatment would affect myogenesis, proliferating C2C12 murine myoblasts were cultured under 1% O₂ (hypoxic, H) or 21% O₂ (normoxic, N) conditions for 24 hours, and then they were induced to differentiate for seven days under normoxic conditions (21% O₂), by switching to the differentiation medium containing 2% horse serum (HS), as deeply described in the Materials and Methods. At the end of the differentiation process, the extensive formation of

myotubes could be observed in both hypoxic or normoxic pre-conditioned cell plates, and they stained positive for myosin heavy chain (MHC) by immunofluorescence (**Figure 2A**). A quantitative analysis of the differentiation revealed that the hypoxic pre-treatment induced the formation of hypertrophic myotubes, with a 1.4-fold increase in the differentiation index, as compared to normoxic controls, while no significant differences were observed in the fusion index (**Figure 2B**).

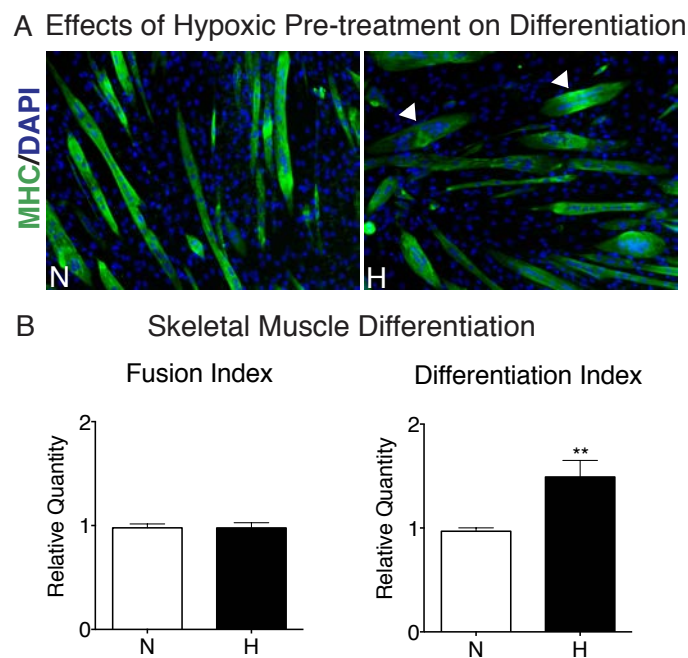

Figure 2. Effects of hypoxia on C2C12 muscle differentiation. C2C12 cells were induced to differentiate under normoxia after 24 hours of preconditioning in 1% O₂ and compared with controls that had been kept under normoxia. Immunofluorescence staining at the end of differentiation revealed the formation of myotubes expressing MHC (green). Cell nuclei were stained with DAPI (blue). Original magnification 100X. (A). Two differentiation parameters were calculated: the fusion index, as the ratio between MHC-positive nuclei and the total number of nuclei, and the differentiation index, as the ratio between the average of myotubes area and nuclei localized in the MHC-positive myotubes (B). Data represent mean±SEM of 6 independent experiments. The results are expressed as fold-change in comparison to normoxia. Statistical significance was determined by Student's t test. **P < 0.01.

Then, in order to assess how the hypoxic pre-conditioning affected myogenesis, each different phase of the process was analyzed, starting from the nuclear localization of the earliest differentiation marker MyoD. Results showed that the hypoxic pre-conditioning induced a 3-fold increase of MyoD localization in the nuclei (**Figure 3A**). Moreover, the mRNA expression levels of ID1 and MyoR, the two main MyoD corepressors, were significantly down-regulated of about 50% and 30%, respectively, after 24 hours under hypoxia, and their expression level remained lower than controls throughout the differentiation process (**Figure 3B**).

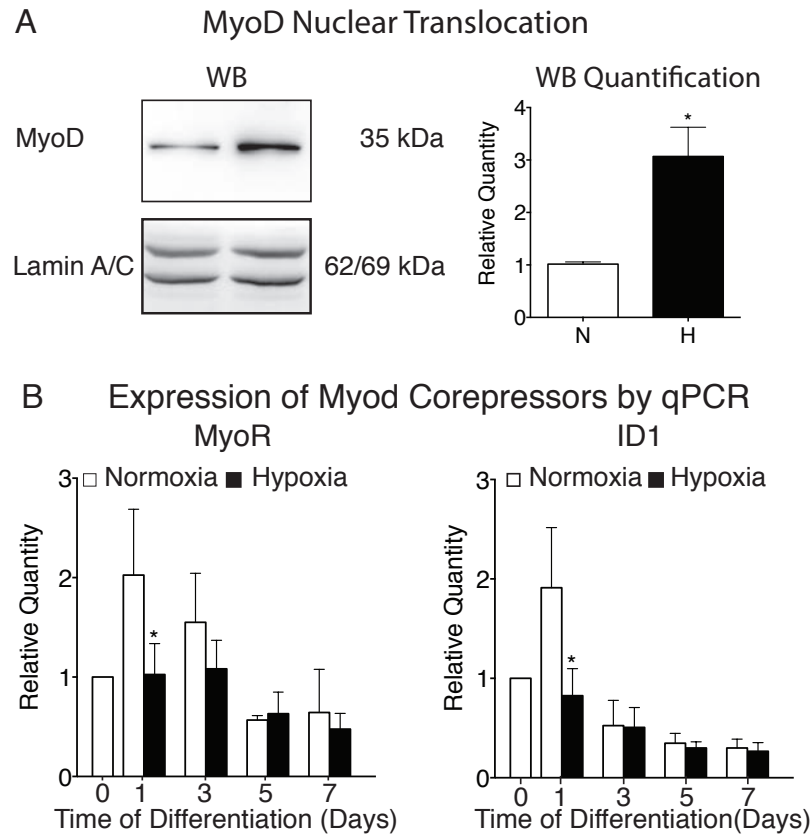

Figure 3. Activation of MyoD. Western blot (WB) and relative quantification of MyoD subcellular localization were performed after hypoxia pretreatment and nuclei separation using Lamin A/C as a nuclear marker (A). Gene expression of MyoD corepressors, MyoR, and ID1, was measured by qPCR during the differentiation process (B). Data represent means \pm SEM of 4 independent experiments for the WB analyses and 5 replicates for the gene expression experiments. The results were expressed as fold-change in comparison to normoxia and the statistical analysis was determined by Student's t test. *P < 0.05.

Then, Myogenin and MHC, the two main intermediate and late-markers of differentiation, respectively, were evaluated by qPCR, revealing that hypoxia pre-conditioning induced an increase of Myogenin, that was 1.66- and 2.4-folds higher, at the end of the 24 hours hypoxic pre-conditioning (day 0 of differentiation) and after three days of differentiation (day 3), as compared to normoxic controls (Figure 4A). Analysis of the terminal differentiation marker MHC by qPCR at the end of differentiation (day 7) revealed that its expression was 1.33-folds higher in hypoxia pre-conditioned cells than in controls (Figure 4B).

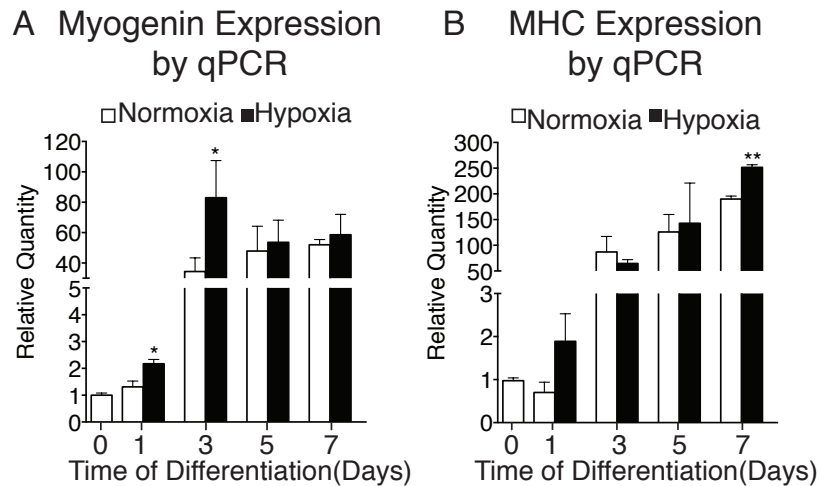

Figure 4. Effects of hypoxia on myogenic markers. Gene expression of myogenin (A) and MHC (B) was analyzed by qPCR during differentiation of C2C12 cells pretreated in hypoxia or normoxia and then induced to differentiate in normoxic culture conditions. Data represent means \pm SEM of 4 independent experiments and the results were expressed as fold- change in comparison to normoxia. The statistical analysis was determined by Student's t test. *P < 0.05; **P < 0.01.

4. MECHANISTIC STUDY OF HIF-1 α -INDUCED ACTIVATION OF MYOD

We then investigated the hypothesis of a possible direct link between the activation of HIF-1 α and the accumulation of MyoD into the nuclei. Along this line, it is known that a class of secreted proteins, called WNTs, are finely regulated under hypoxia, and they are also known to regulate the expression of MyoD. Therefore, we tested whether the hypoxic pre-conditioning would alter either the canonical or the non-canonical pathway of β -catenin. Results showed that hypoxia inhibited the canonical WNT pathway by reducing the nuclear translocation of β -catenin (-50%) and by inducing a marked down-regulation of its target genes TCF7 (-52%) and Cyclin D1 (-25%) (Figure 5A).

On the contrary, we found the activation of the non-canonical WNT pathway. In fact, qPCR analysis showed a significant increase of WNT7a, WNT9a, and WNT4, of 1.75-, 1.55-, and 1.23-folds, respectively, was observed after 24 hours of hypoxic pre-conditioning (Figure 5B). To further confirm the activation of the non-canonical pathway, the β -catenin translocation to the plasma membrane was analyzed, which is known to be induced by WNTs. The WB analysis of the plasma membrane fraction revealed a 1.66-fold increase of β -catenin, as compared to normoxic controls (Figure 5B).

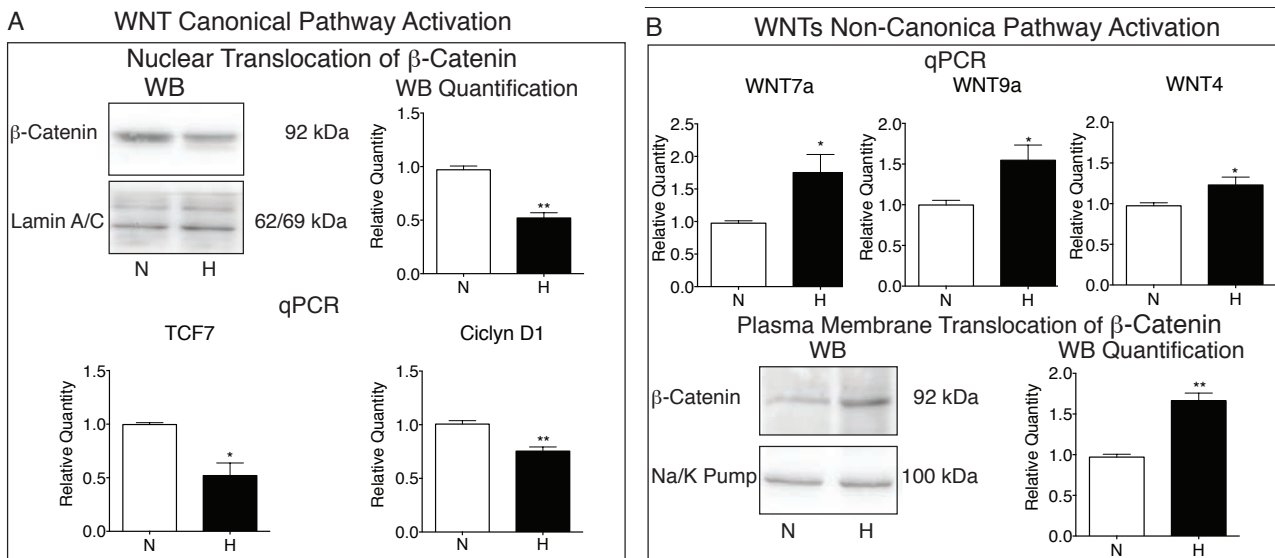

Figure 5. Canonical and non-canonical WNT pathway analyses. (A) Analysis of the WNT canonical pathway was performed by measuring the nuclear translocation of β -catenin by Western blot (WB) with its relative quantification using Lamin A/C as marker after nuclei separation and evaluating the gene expression of its target genes by qPCR. (B) Analysis of the WNT non-canonical pathway was performed by evaluating gene expression of WNT7a, WNT9a, and WNT4 by qPCR, and the β -catenin subcellular localization by WB, using Na⁺/K⁺ ATPase as marker after plasma membrane separation. Data represent means \pm SEM of 5 independent replicates for the gene expression analyses and 4 experiments for the β -catenin translocation. Results are expressed as fold-change in comparison to normoxia and the statistical analysis was determined by Student's t test. *P < 0.05; **P < 0.01. H, hypoxia; N, normoxia.

Then, we tested whether the hypoxic pre-conditioning was responsible for the activation of MyoD mediating the non-canonical WNT pathway.

To validate this hypothesis, HIF-1 α was silenced in C2C12 myoblasts by stable transfection with shHIF1 α (HIF-1 α ⁻) plasmid, while the scrambled shCTR (HIF-1 α ⁺) was used as controls. Cells were then cultured under hypoxia for 24 hours and the inhibition of HIF-1 α was evaluated by WB. Results revealed that HIF-1 α ⁻ cells showed a decrease of HIF-1 α nuclear translocation (-40%), as compared to controls (HIF-1 α ⁺ cells, **Figure 6A**), while a negligible amount of protein was found in the cytosolic fraction (data not shown).

Moreover, the down-regulation of HIF-1 α induced also a decrease of WNT7a protein expression (-50%) as shown in the WB (**Figure 6B**) and a reduction of MyoD localization into the nuclei (-60%) (**Figure 6C**).

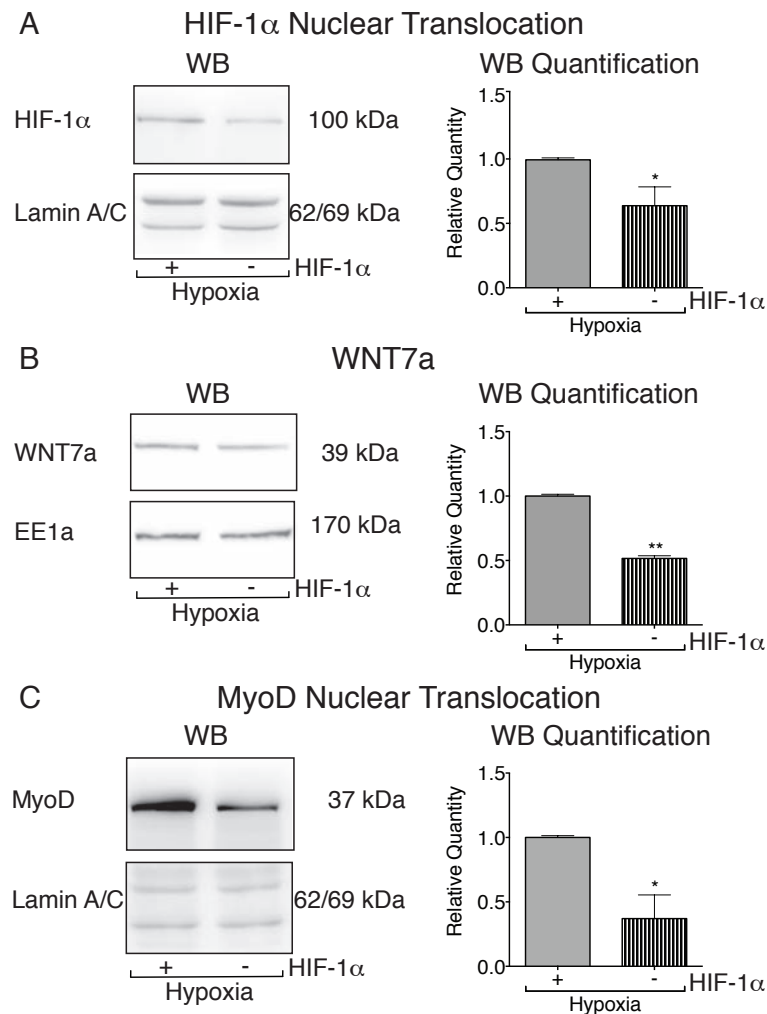

Figure 6. Effects of HIF-1 α inhibition on C2C12 myoblasts. Silencing of HIF-1 α was performed in C2C12 myoblasts. **A)** HIF-1 α inhibition was evaluated after preconditioning for 24 hours in 1% O₂ and analyzing the nuclear translocation of HIF-1 α in HIF-1 α ⁻ cells by Western blot (WB) with relative quantification to control cells (HIF-1 α ⁺) using Lamin A/C as marker after nuclei separation, while a negligible amount of protein was found in the cytosolic fraction (data not shown). **B, C)** WB and relative quantification were also used to measure WNT7a protein levels (**B**), using EE1a as marker, and the nuclear localization of MyoD protein (**C**), after nuclei separation and using Lamin A/C as marker, in HIF-1 α ⁻ as compared with control HIF-1 α ⁺ cells. Data represent means \pm SEM of 3 independent experiments. The statistical analysis was determined by Student's t test. *P < 0.05; **P < 0.01.

Then, to further understand the role played by HIF-1 α during differentiation, HIF-1 α ⁺ and HIF-1 α ⁻ cells were cultured under hypoxic conditions for 24 hours and then induced to differentiate in 2% HS for seven days. At the end of the differentiation process, cells were stained for myosin heavy chain (MHC) (**Figure 7A**). Results showed that the inhibition of HIF-1 α induced a decrease of about 90% and 70% in fusion and differentiation indexes, respectively, as compared to HIF-1 α ⁺ cells (**Figure 7B**). Moreover, a significant reduction in myogenin expression (-53%) could be observed by qPCR at day three of differentiation (day 3), as well as in MHC expression (-33%) at the end of the differentiation process (day 7), as compared to controls (**Figure 7C**).

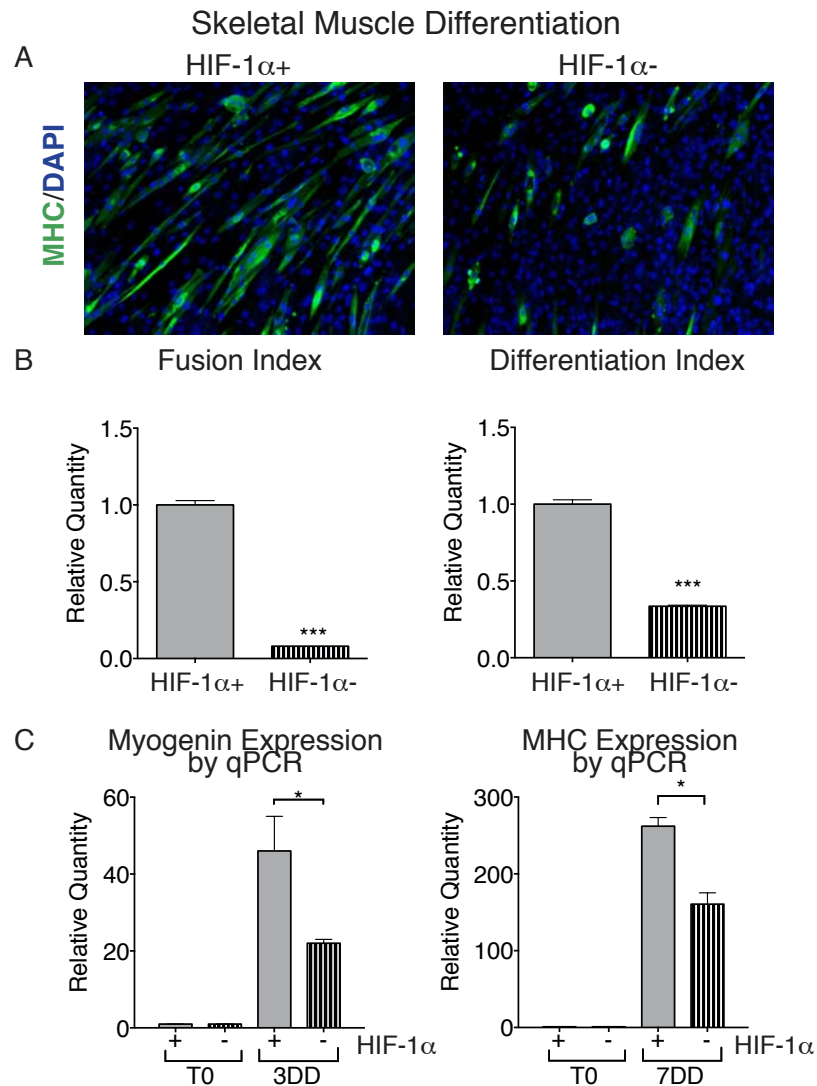

Figure 7. Effects of HIF-1 α silencing on skeletal muscle differentiation. HIF-1 α ⁺ and HIF-1 α ⁻ were induced to differentiate under normoxia after preconditioning for 24 hours in 1% O₂. Immunofluorescence staining at the end of the differentiation process revealed the formation of myotubes expressing MHC (green). **A)** Cell nuclei were stained with DAPI (blue). Original magnification 100X. **B)** Two differentiation parameters were calculated: the fusion index, as the ratio between MHC-positive nuclei and the total number of nuclei, and the differentiation index, as the ratio between the average of myotubes area and nuclei localized in the MHC-positive myotubes. **C)** Gene expression of myogenin, at the third day of differentiation (3DD), and MHC, at the seventh day of differentiation (7DD), were analyzed by qPCR during the differentiation process. Data represent means \pm SEM of 3 independent experiments. Results are expressed as fold change compared with the control HIF-1 α ⁺. Statistical significance was determined by Student's t test. *P < 0.05; ***P < 0.001.

Then, we investigated the involvement of the non-canonical WNT pathway during myogenesis. To this purpose, the WNT pathway was inhibited using XAV939, a known and specific inhibitor that promotes the phosphorylation and degradation of β -catenin through the action of Axin2. Thus, myoblasts were cultured in the presence of 40 μ M XAV939 under hypoxia for 24 hours, and then switched to normoxia and induced to differentiate in 2% HS for seven days. Results were compared to those of control myoblasts, that were pre-conditioned under hypoxia but without the addition of XAV939 in the culture medium, without inhibiting the WNT pathway. At the end of the

differentiation process, cells were stained for myosin heavy chain (MHC) expression (**Figure 8A**). Results revealed that the inhibition of the WNT pathway with XAV939 induced a decrease of about 55% and 50% in the fusion and differentiation indexes, respectively, as compared to controls (**Figure 8B**).

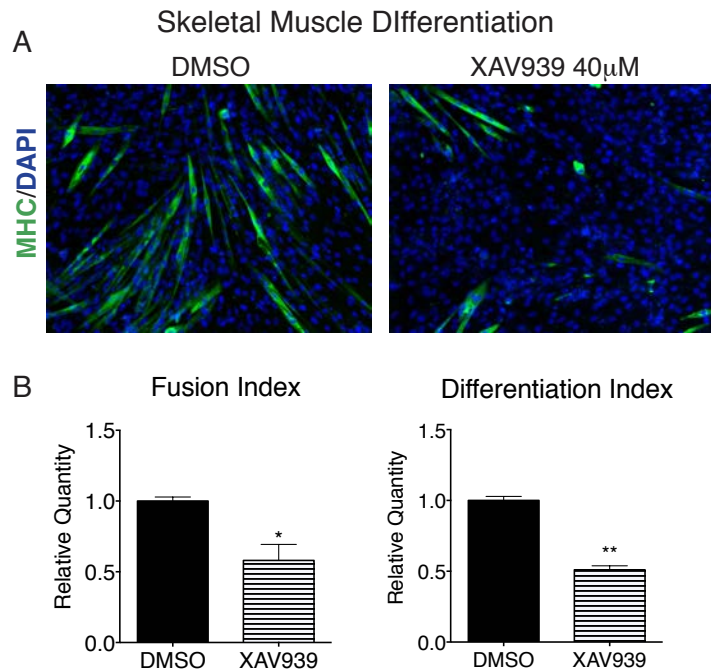

Figure 8. Effects of WNT inhibition on skeletal muscle differentiation. C2C12 cells were treated with 40 μ M of XAV939 under hypoxic conditions and induced to differentiate for 7 days. **A**) Immunofluorescence staining was performed at the end of the differentiation, revealing myotubes expressing MHC (green), and the nuclei were stained with DAPI (blue). Original magnification 100X. **B**) Two differentiation parameters were calculated: the fusion index, as the ratio between MHC-positive nuclei and the total number of nuclei, and the differentiation index, as the ratio between the average of myotube area and nuclei localized in the MHC-positive myotubes. Data represent means \pm SEM of 3 independent experiments. Results are expressed as fold changes as compared with controls that were cultured in the presence of DMSO. Statistical significance was determined by Student's t test. *P < 0.05; **P < 0.01.

Moreover, differentiation markers analysis showed a decrease in the nuclear translocation of MyoD (-25%) (**Figure 9A**), as well as a reduction in the expression of Myogenin (-49%) and MHC (-52%), at 0, 3, and 7 days of differentiation, respectively (**Figure 9B**).

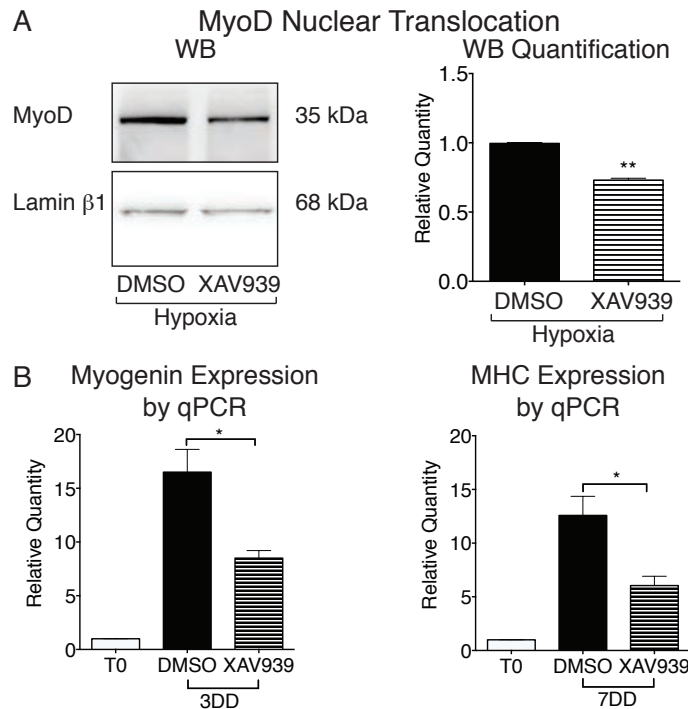

Figure 9. Analyses of differentiation markers after XAV939 treatment. **A)** C2C12 were treated with XAV939 to inhibit the WNT pathway. Nuclear localization of MyoD was investigated by Western blot (WB) and relative quantification after nuclei isolation and using Lamin β 1 as a marker (Lamin A/C could not be used as its expression changed during treatment). **B)** Gene expression of myogenin and MHC was determined by qPCR at day 3 and 7 of differentiation, respectively. Data represent means \pm SEM of 3 independent experiments. Results are expressed as fold changes as compared with controls cultured in the presence of DMSO. Statistical significance was determined by Student's t test. *P < 0.05; **P < 0.01.

5. EFFECTS OF TWO COMMERCIAL PHDs INHIBITORS ON C2C12 CELLS

Two commercial PHDs inhibitors have been characterized and tested: IOX2 and FG-4592 (**Figure 10A**). The half maximal inhibitory concentration (IC₅₀) represents the concentration of a drug that is required for 50% inhibition in vitro of the activity of the PHDs was measured by a luciferase assay. Following manufacturer's instructions, C2C12 were transfected for 24 hours with two plasmids: either the Luciferase-pcDNA3 plasmid (luciferase control vector) or the ODD-Luciferase-pcDNA3 plasmid (a vector containing the ODD domain of HIF-1 α cloned just upstream the gene of Luciferase) (80 ng) and as a second vector, the pRL-CMV plasmid expressing the Renilla gene, which acts as the internal control of the transfection (8 ng).

Then, cells were treated with PHDs inhibitors at different working concentrations (10 μ M, 25 μ M, 50 μ M, 100 μ M) for 24 hours. The activity of PHD inhibitors turns out to be directly proportional to the translation of the ODD-HIF-1 α cloned upstream the luciferase gene, and it was detected using the Dual Glo Luciferase assay kit (Promega). We performed a linear regression analysis, which

correlates the inhibition rate with the concentration of each inhibitor, and the IC₅₀ value for each compound was calculated. The results showed that the IC₅₀ values of IOX2 and FG-4592 were 50 μ M and 40 μ M respectively (**Figure 10B**).

Then, the effects of IC₅₀ concentration on cell viability and toxicity were investigated after 24 hours of treatment. IOX2 and FG-4592 molecules were used at the chosen concentrations of 50 μ M and 40 μ M respectively. The results were compared with those obtained with control cells (CTRL), which were cultured at the same time point in growth medium in the absence of inhibitors, in the presence of DMSO. Cell proliferation was measured by RealTime Glo™ (Promega) assay while cell cytotoxicity was measured using the CellTox™ (Promega) assay. Results showed no significant changes in the proliferation rate and in the cytotoxicity, confirming that the treatment did not induce any evident alteration of the cellular behavior (**Figure 10C**).

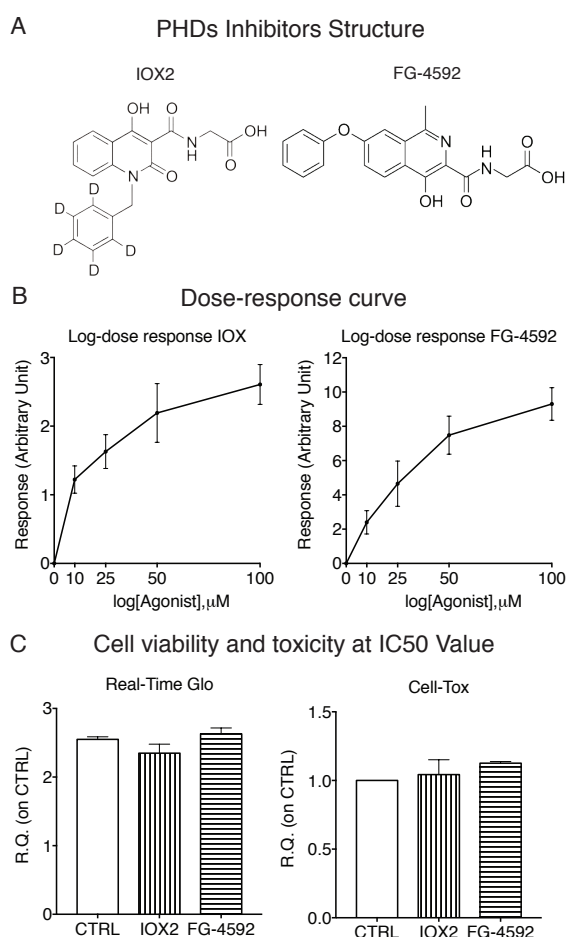

Figure 10. PHDs inhibitors characterization and their effects on murine myoblasts C2C12 on cell proliferation and toxicity. The commercial available PHDs inhibitors, IOX2 and FG-4592 (**A**), are characterized and tested for the IC₅₀ calculation using 10, 25, 50, 100 μ M working concentrations (**B**). Their effects on C2C12 cells treated for 24 hours at the IC₅₀ working concentrations were analyzed evaluating the viability and toxicity (**C**). Data represent mean \pm SEM of five independent experiments.

6. ACTIVATION OF HIF-1 α PATHWAY

Based on the previous experiments, C2C12 were treated for 24 hours with 50 μ M IOX2 and 40 μ M FG-4592. Initially, it was tested whether a pre-conditioning treatment with a PHD inhibitor could activate HIF-1 α . To this purpose, the results obtained from the IC50 calculation were used to measure the activation of the HIF-1 α oxygen-responsive domain (ODD) by a luciferase assay.

The activity of PHD inhibitors turns out to be directly proportional to the translation of the ODD-HIF-1 α cloned upstream the luciferase gene. In particular, it was observed that IOX2 and FG-4592 induced a 2.19- and 3.95-fold increase, respectively, as compared with the controls (**Figure 11A**). These data were also confirmed by the analysis of HIF-1 α localization by western blot after nuclei isolation, which revealed that IOX2 and FG-4592 promoted its nuclear localization of 8.78- and 14.98-fold increase, respectively, as compared with the controls (**Figure 11B**), as shown from the 100 kDa band in the WB (while a negligible amount of protein was found in the cytosolic fraction (data not shown)).

Moreover, quantitative PCR (qPCR) analysis of key HIF-1 α target genes revealed a 1.64- and 4.43-fold increase in the expression levels of VEGF and PHD2 with IOX2 treatment, whereas FG-4592 promoted a 2.15- and 4.83-fold increase in the mRNA levels of the same genes, as compared with the controls (**Figure 11C**).

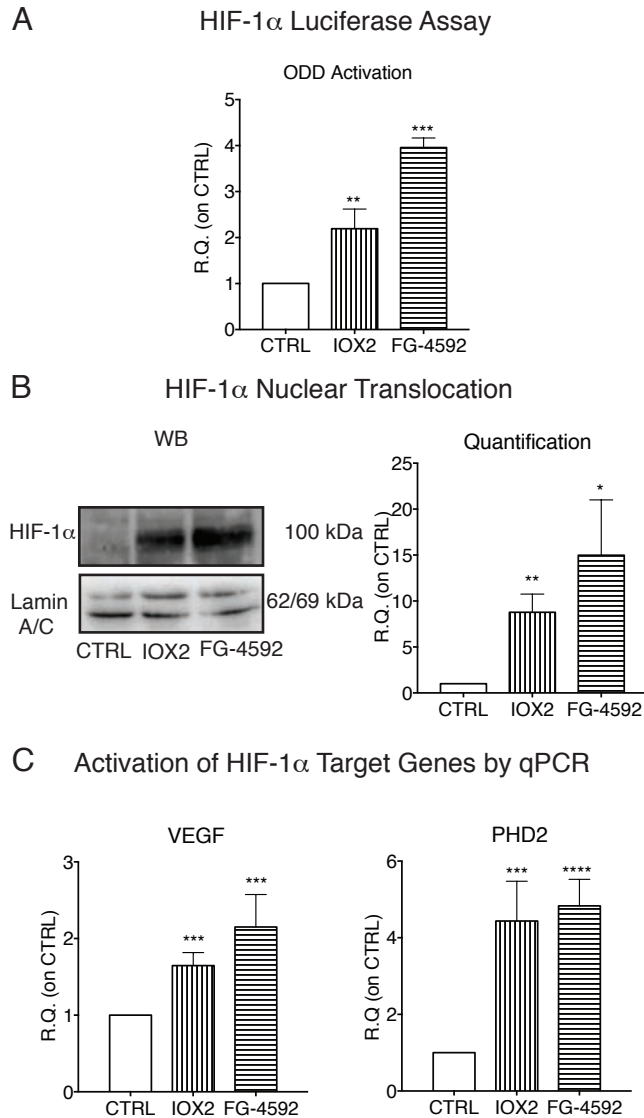

Figure 11. Effects of PHDs inhibitors on HIF-1 α activation.

Cells were treated with 50 μ M IOX2 and 40 μ M FG-4592 for 24 hours and the activation of the HIF-1 α pathway was analyzed measuring the activity of oxygen-responsive domain (ODD) by a Luciferase assay (A), evaluating the HIF-1 α nuclear translocation by western blot, after nuclei separation and using Lamin A/C was used as nuclear marker, while a negligible amount of protein was found in the cytosolic fraction (data not shown). (B), and quantifying the gene expression of its target genes, VEGF and PHD2, by qPCR (C). Data represent mean \pm SEM of three independent experiments for luciferase assay, four for gene expression and three for western blot, and the statistical analysis was determined by t-test. * $p < 0.05$, ** $p < 0.01$, *** $p < 0.001$, **** $p < 0.0001$.

7. EFFECTS OF THE CHEMICAL ACTIVATION OF HIF-1 α ON MYOGENIC DIFFERENTIATION

To test the effects of a chemical activation of HIF on myogenesis, cells were cultured for 24 hours in growth medium (GM) or treated with the inhibitors, in the presence of 50 μ M IOX2 or 40 μ M FG-4592. Upon reaching 70-80% of cell confluence, after 24 hours of treatment, GM was replaced with differentiation medium (DM) containing 2% HS to induce myogenic differentiation for

seven days. At the end of the differentiation process, the extensive formation of myotubes could be observed and they were stained positive for MHC by immunofluorescence (**Figure 12A**). A quantitative analysis of the differentiation revealed that a chemical pre-treatment induced the formation of hypertrophic myotubes, with a 1.47- and 1.28-fold increase in the differentiation index upon IOX2 and FG-4592 treatment, respectively, as compared to the controls, while no significant differences were observed in the fusion index values (**Figure 12B**).

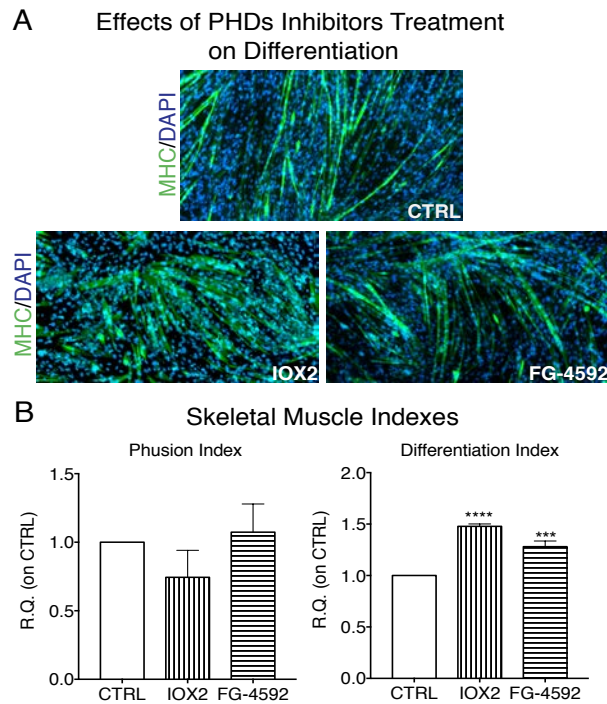

Figure 12. Effects of PHDs inhibitors on C2C12 skeletal muscle differentiation.

C2C12 were treated for 24 hours with 50 μ M IOX2 and 40 μ M FG-4592 and then induced to differentiate in presence of 2% HS. Immunofluorescence staining at the end of differentiation revealed the formation of myotubes expressing MHC (green). Cell nuclei were stained with DAPI (blue). Original magnification 100X. **(A)**. Two differentiation parameters were calculated: the fusion index, as the ratio between MHC-positive nuclei and the total number of nuclei, and the differentiation index, as the ratio between the average of myotubes area and nuclei localized in the MHC positive myotubes **(B)**. Data represent mean \pm SEM of three independent experiments and the results were expressed as fold-change in comparison to controls. The statistical analysis was determined by t-test, ***p < 0.001, ****p < 0.0001.

Then, in order to assess how the chemical pre-conditioning affected myogenesis, each different phase of the process was analyzed, starting from the nuclear localization of the earliest differentiation marker MyoD. The 35 kDa band showed the presence of MyoD at the nuclear level, whereas the housekeeper Lamin A/C protein was selected as its normalizer. Results showed that IOX2 and FG-4592 induced a 1.57- and 1.50-fold increase of MyoD localization in the nuclei, compared with the controls (**Figure 13A**), confirming that the activation of HIF-1 α , promoted by the chemical inhibition of PHDs, has pivotal effects on the early phases of muscle differentiation.

Moreover, the mRNA expression levels of MyoR, the main MyoD corepressor, were significantly down-regulated of about 54% and 61%, upon IOX2 and FG-4592 treatments, respectively, as compared with the controls (**Figure 13B**), as expected.

Then, Myogenin and MHC, the main intermediate and late-markers of differentiation, were evaluated by qPCR, revealing that chemical pre-conditioning induced an increase of both them: IOX2 and FG-4592 induced a 2- and 1.42-fold increase of Myogenin after 3 days of differentiation and 2.21- and 2.34-fold increase of MHC after 7 days of differentiation, respectively, compared with the controls (**Figure 13C**).

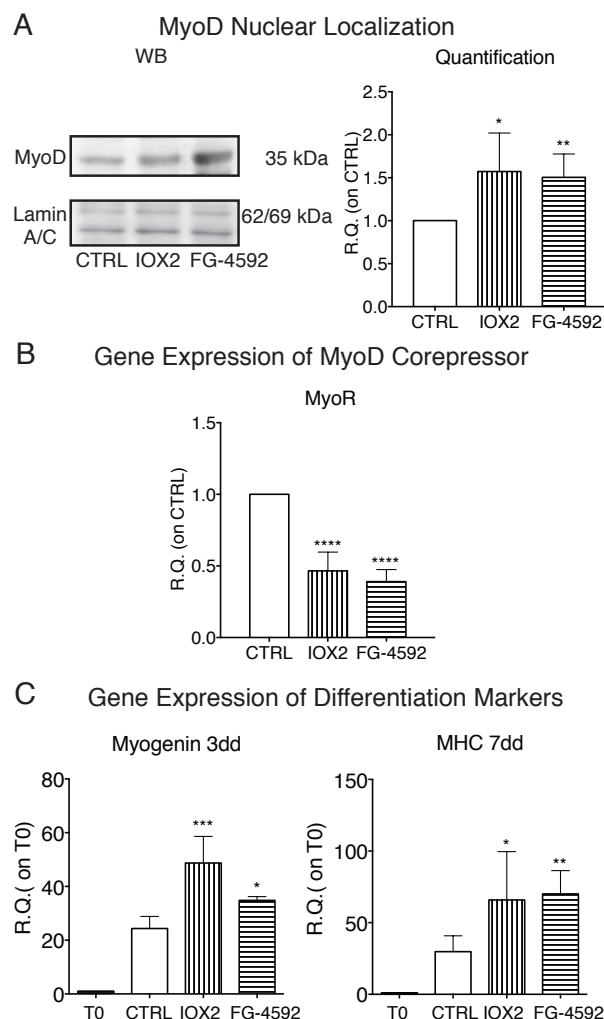

Figure 13. Activation of myogenic markers upon chemical treatment with PHDs inhibitors.

The effects of treatment with 50 μ M IOX2 and 40 μ M FG-4592 on differentiation markers were performed analyzing the MyoD nuclear localization by western blot after nuclei separation and using lamin A/C as a nuclear marker (**A**), measuring the gene expression of MyoD co-repressor MyoR by qPCR (**B**) and evaluating the expression level of myogenin and MHC (**C**) by qPCR during differentiation (3dd and 7dd, third and seventh day of differentiation, respectively). Data represent mean \pm SEM of four independent experiments for the Western Blot analyses, while three replicates for the gene expression experiments. The results were expressed as fold-change in comparison to controls and the statistical analysis was determined by t-test. * $p < 0.05$, ** $p < 0.01$, *** $p < 0.001$.

8. MECHANISTIC STUDY OF HIF-1 α -INDUCED ACTIVATION OF MYOD

As previously described for physical hypoxia, we finally assessed whether there was a mechanistic link between the activation of HIF-1 α and MyoD. Therefore, we tested whether a chemical activation of HIF-1 α would promote the same up-regulation of the WNT non-canonical pathway, with the hypothesis that HIF-1 α could directly bind on the promoter region of WNT7a. In fact, it was previously described that HIF-1 α directly binds the WNT7a HRE sequences in a model of oligodendrocyte (Yuen et al. 2014).

Therefore, we further investigated how the chemical pre-conditioning with PHDs inhibitors affected WNTs pathway and found that WNT4 and WNT7a, key WNTs involved in cell differentiation, were upregulated. In particular, results demonstrated that IOX2 induced a 1.46- and 1.41-fold increase in WNT4 and WNT7a gene expression; similar results were obtained by FG-4592 treatment, which up-regulated of 1.45- and 2.32-fold the gene expression of WNT4 and WNT7a (**Figure 14A**).

In order to confirm the activation of WNT non-canonical pathway, it was set up a luciferase assay in which the expression of luciferase was under the control of WNT7a promoter, as extensively described in Materials and Methods. In fact, it was already demonstrated in the literature the crucial role played by WNT7a during skeletal muscle differentiation, generating an increased number of larger fibers (von Maltzahn et al. 2011, von Maltzahn et al. 2013, Bentzinger et al. 2014). Therefore, murine myoblasts C2C12 were treated with 50 μ M IOX2 and 40 μ M FG-4592 for 24 hours. At the same time, as a positive control we decided to use physical hypoxia (1% O₂), and all data were compared to the negative control, treated with DMSO. The results showed that both physical and chemical HIF-1 α activation induced an increase of luciferase signal, leading to an enhancement of WNT7a promoter activity. In particular, it was observed that hypoxia promoted a 1.98-fold increase and, in parallel, IOX2 and FG4592 induced a 1.4- and 1.3-fold increase, compared with the controls (**Figure 14B**), confirming that HIF-1 α strictly regulates WNT7a gene expression.

Gene Expression of WNT non Canonical Markers by qPCR

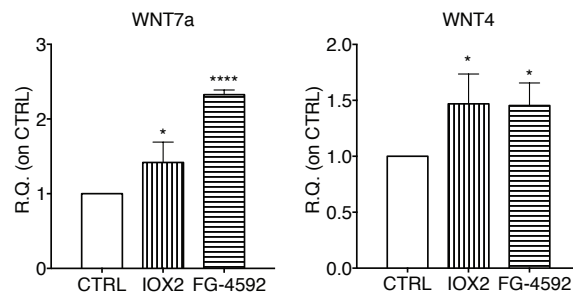

Regulatory Effects of HIF-1 α on WNT7a Promoter

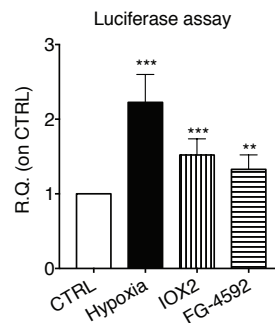

Figure 14. Activation of WNT non-canonical pathway.

The study of WNT Non-Canonical pathway was performed analyzing the gene expression of WNT7a and WNT4 by qPCR (A) and the regulatory activity of HIF-1 α on WNT7a promoter by luciferase assay (B). In both experimental procedures C2C12 were treated with 50 μ M IOX2 and 40 μ M FG-4592 for 24 hours. In particular, for the luciferase assay physical hypoxia (1% O₂) was used as positive control, and all data were compared to the negative control (DMSO). Data represent mean \pm SEM of three independent replicates for the gene expression analyses and for luciferase assays. Results are expressed as fold-change in comparison to controls and the statistical analysis was determined by t-test. *p < 0.05, **p < 0.01, ***p < 0.001.

Then we investigated the binding sequences of HIF-1 α on the WNT7a promoter. To this purpose, we decided to activate HIF-1 α under hypoxia and not pharmacologically, to avoid any possible off-target effect. Therefore, cells were cultured for 24 hours under normoxic (21% O₂) or hypoxic (1% O₂) culture conditions and the region upstream of the starting coding sequence of WNT7a (ATG), constituted by 1000bp, was analyzed.

In this region, seven possible binding sequences were identified, which were characterized by the *Hypoxia Responsive Elements (HRE)* of HIF-1 α (5'-CGTG-3') (Pescador et al. 2005). The binding of HIF-1 α to these regions was analyzed performing ChIP experiments, as deeply described in Materials and Methods (Figure 15A).

Upon genomic immunoprecipitation, using specific HIF-1 α antibody, while no significant binding was observed in normoxia, two different regions of over-lapping were identified in hypoxia

corresponding to *nt -995 -843* and *nt -653 -484*, validating that HIF-1 α directly binds WNT7a promoter and regulates its gene expression (**Figure 15B**).

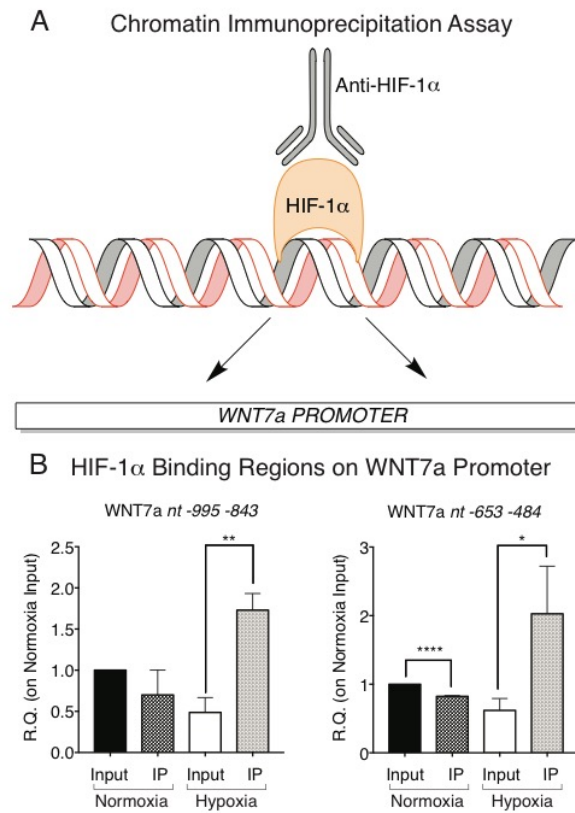

Figure 15. Regulatory effect of HIF-1 α on WNT7a promoter.

A ChIP assay was performed on C2C12 treated upon physical hypoxia (1% O₂) for 24 hours to investigate the direct link between HIF-1 α and WNT non-canonical pathway (**A**). The immunoprecipitation was conducted using antibodies against HIF-1 α or IgG mouse, as negative control. After immunoprecipitation, the genomic DNA was analyzed by qPCR and two distinct HRE binding sequences were identified, in comparison to the input of normoxia (*nt -995 -843*; *nt -653 -484*). Binding was not observed in non-treated controls (normoxia) (**B**). Data represent mean \pm SEM of three independent replicates. Results are expressed as fold-change and the statistical analysis was determined by t-test. * $p < 0.05$, ** $p < 0.01$, *** $p < 0.0001$.

DISCUSSION AND CONCLUSIONS

Skeletal muscle differentiation is a complex biological process characterized by different phases. During myogenesis, proliferating muscle cells, called myoblasts, arrest their growth, exit the cell cycle, express muscle-specific genes, then form the multinucleated myotubes and finally fuse into myofibers. This process is finely regulated by several key markers such as MyoD, Myogenin and MHC. In particular, MyoD has been recognized as the main regulator of myoblast cell fate by its ability to bind specific DNA sequences, called E-boxes, ultimately activating myogenic differentiation (Weintraub 1993, Olson and Klein 1994). The proliferating myoblasts express the early marker MyoD, the first activator of myogenesis, which blocks the proliferative stimulus and induces the expression of myogenin, that in turn promotes differentiation and fusion in myotubes (Lassar et al. 1994). The formation of myotubes leads to the fusion into myofibers that will express MHC isoforms at different levels depending on the fate of the myofiber (Allen et al. 2001).

In order to ensure the proper muscle development and cell survival, a constant supply of oxygen is needed, which is the main source of energy for all mammals (Semenza 2010). For this reason, cellular oxygen levels are finely tuned and an altered oxygen partial pressure could have detrimental effects on cell state. In this context, HIF-1 α is the major regulator of oxygen homeostasis and regulates the expression of several genes (Yoon et al. 2006). In fact, HIF-1 α mediates cell responses to hypoxia by regulating glucose uptake, anaerobic metabolism in oxygen-depleted environments (Carmeliet et al. 1998), angiogenesis (Levy et al. 1995), survival (Krishnamachary et al. 2003), differentiation (Kim et al. 2015). As previously described, HIF-1 α is a heterodimeric transcription factor consisting of a constitutively expressed β -subunit and an oxygen-regulated α -subunit. In the α -subunit, there is an oxygen-dependent degradation (ODD) domain, which is hydroxylated by proline-hydroxylases (PHDs), rendering the α -subunit vulnerable to proteasomal degradation under normoxia (Huang et al. 1998). On the contrary, when the amount of oxygen is limited, in hypoxic conditions, PHDs are inhibited, thus HIF-1 α is stabilized, it can translocate to the nucleus and it activates the transcription of its target genes (Huang et al. 1996).

In the literature, the role of HIF-1 α during skeletal muscle differentiation is quite controversial. In fact, while it is known that HIF-1 α is implicated in muscle cell development, vascular formation, and energy metabolism in skeletal muscle (Ono et al. 2006, Niemi et al. 2014, Thom et al. 2014, Xie et al. 2014), several studies demonstrated that a chronic activation of HIF-1 α turns out to be detrimental for skeletal muscle differentiation as it blocks the myogenic process by inducing the degradation of MyoD (Di Carlo et al. 2004, Majmundar et al. 2012). Indeed, these findings support

the concept that hypoxia is necessary for adult stem cells to preserve their undifferentiated state, as they usually reside in those hypoxic tissue districts known as the *hypoxic niches* (Morrison and Spradling 2008, Liu et al. 2012). On the other hand, it is known that upon an ischemic insult, muscle regeneration occurs once the normal blood flow is restored. Therefore, the role of HIF, whose activation is strictly oxygen-dependent, could be crucial also in the activation of muscle regeneration.

Along this line, we tested the hypothesis that the activation of HIF-1 α could play a role not only in preventing stem cell differentiation, but also in preparing satellite muscle, *i.e.* inducing their commitment toward differentiation, once oxygenation is restored. To this purpose, we used two different approaches to activate HIF: (a) *physical hypoxia*, obtained by culturing cells in a hypoxic incubator at 1% O₂, and (b) *chemical hypoxia*, obtained by a pharmacological inhibition of the prolyl-hydroxylases (PHDs), ultimately activating HIF-1 α .

Overall, in this Ph.D. thesis, we found that a transient (up to 24 hours) activation of HIF-1 α , either under physical or chemical conditions, leads to an increase of MyoD, mediated by the Wnt non-canonical pathway. In particular, a transient activation of HIF-1 α renders myoblasts more committed to differentiation and, upon oxygen restoration, they complete the differentiation process by forming hypertrophic myotubes. In particular, we initially confirmed that hypoxia greatly reduces the proliferation rate of C2C12 myoblasts, that enter a pseudo-quiescent state, as expected (Greenbaum 1997, Di Carlo 2004) and differentiation is inhibited. However, hypoxia does not induce any significant cell death during the first 24 hours of treatment. Nonetheless, we confirmed that prolonged exposure to severe hypoxia ultimately leads to cell death. Thus, in this study, we limited the hypoxic pre-conditioning time to 24 h. Moreover, in order to propose a possible new translational approach, we decided to mimic the effects obtained by physical hypoxia also using two commercially available PHDs inhibitors, IOX2 and FG-4592, the later under Phase III clinical trial for the treatment of renal anemia (Maxwell and Eckardt 2016). We used the PHDs inhibitors at their IC₅₀ working concentrations and we observed that a 24 hours pre-treatment is sufficient to activate HIF-1 α , as confirmed by its shift to the nucleus and by the activation of its main target genes, mimicking what we previously observed under physical hypoxia (1% O₂) (Cirillo et al. 2017). Then, we tested whether our pre-conditioning would affect myoblasts differentiation under standard culture conditions (normoxia and differentiation medium, DM). Upon both treatments, we found that pre-conditioned myoblasts completed each step of the differentiation process earlier than controls, and they formed hypertrophic myotubes, as confirmed by the significant increase in the differentiation index. On the other hand, no statistical differences could be observed in the fusion index value, supporting the notion that the pre-conditioning did not cause an increase in the total number of myotubes but rather in their size. In order to investigate the possible mechanism behind these surprising data, we measured

the expression of some key markers during differentiation. In particular, we found that both hypoxic pre-conditioning and the pre-treatment with PHDs inhibitors significantly induced the activation of MyoD.

Actually, it is well known that MyoD is a constitutive transcription factor (Berkes and Tapscott 2005), which can be found in two different forms: (a) the *active* form, which is localized in the nucleus and bound to E-protein (whose activity is necessary to induce the transcription of MyoD target genes, including myogenin) or (b) the *inactive* form, which is initially localized in the nucleus but it is rapidly degraded in a proteasome-dependent manner (Benezra et al. 1990), due to the binding between the E-protein, necessary to activate the transcription, to the inhibitors of differentiation, such as ID1 and MyoR (Benezra et al. 1990, Berkes and Tapscott 2005). Results showed that an hypoxic pre-conditioning caused an increase in MyoD nuclear localization, which was accompanied by a decrease in MyoR and ID1 expression levels. Remarkably, also a chemical activation of HIF-1 α increased the accumulation of MyoD into the nuclei and down-regulated the expression of MyoR. Based on these findings, we hypothesized that HIF-1 α could play a role in activating myoblasts toward myogenesis.

Indeed, a time-course analysis of myogenic markers during differentiation revealed that myogenin expression level was significantly higher than controls at day three of differentiation, supporting an early activation of myogenesis. Moreover, MHC level expressed at the end of the differentiation process (day seven) was significantly higher in pre-conditioned cells than in controls, supporting the increase observed in the differentiation index. On the contrary, no alteration of the fusion index was observed, supporting that HIF-1 α activation did not increase the total number of myotubes, but they became hypertrophic.

In order to understand the mechanism underlying the hypertrophic phenotype observed, we decided to study the possible involvement of the Wnt signaling pathway process. In fact, the Wnt pathway is known to be modulated under hypoxia (Mazumdar et al. 2010) and it plays an essential role during both embryonic muscle development and the maintenance of skeletal muscle homeostasis in the adult by regulating the expression of the myogenic regulatory factors (MRFs) (von Maltzahn et al. 2012). Actually, WNT proteins constitute a large family of secreted glycoproteins that regulate myogenesis in two distinct ways: the *canonical* and *non-canonical pathways*, which are β -catenin dependent or independent, respectively (Sethi and Vidal-Puig 2010). In particular, the canonical Wnt pathway stabilizes β -catenin and activates target genes via TCF/Lef transcription factors, thus promoting the self-renewal and proliferation of satellite cells. On the other hand, the *non-canonical pathway* is β -catenin independent and supports its plasma-membrane translocation, and it is involved in the differentiation process and in the growth of muscle fibers (Tanaka et al. 2011). Along this line, it was demonstrated that WNT4, WNT7a and WNT9a are up-regulated in C2C12 during

differentiation, and that they promote the myogenic processes through the *non-canonical pathway* (Tanaka et al. 2011). In fact, they act as transcription antagonists mediated by β -catenin/TCF and also induce the translocation of β -catenin to the plasma membrane (Berkes and Tapscott 2005). Thus, we first assessed whether the hypoxic pre-conditioning affected WNT expression in C2C12 cells. Our results showed that a 24 hours hypoxic-treatment in 1% O₂, in normal growth medium, caused the inhibition of the *canonical Wnt pathway*, reducing the nuclear translocation of β -catenin and the expression of its target genes TCF7 and CYCLIN D1. Nonetheless, under the same experimental conditions, we observed the activation of the *non-canonical Wnt pathway*, as confirmed by the up-regulation of WNT4, WNT7a and WNT9a, as well as the translocation of β -catenin to the plasma membrane. Moreover, we demonstrated that WNT4 and WNT7a are also up-regulated upon PHDs inhibitors pre-conditioning.

Interestingly, a previous study with slightly, yet possibly crucially, different experimental conditions showed that a 0.5% O₂ treatment for 48 hours, instead of 24 hours, caused a robust down-regulation of the *Wnt canonical pathway*, which determined the complete inhibition of skeletal muscle differentiation (Majmundar et al. 2015). Indeed, during the optimization of our protocol, we found that subjecting C2C12 cells to hypoxia for more than 24 hours caused significant cell death and complete inhibition of the differentiation process, supporting the notion that the effects of sustained hypoxia are strongly due to the treatment length. Nonetheless, under our experimental conditions, we found an activation of the *non-canonical Wnt pathway*, which has been shown to be involved in the migration and differentiation of C2C12 myoblasts (von Maltzahn et al. 2012, Bentzinger et al. 2014). In particular, it has been reported that WNT7a is the main actor in the activation of the *non-canonical Wnt pathway* during the skeletal muscle differentiation, leading to the formation of hypertrophic myotubes. In fact, treatment with exogenous WNT7a increased C2C12 motility and engraftment, resulting in improved muscle strength. Moreover, an increase of WNT7a (by overexpression or by subjecting cells to the recombinant protein in the culture medium) stimulated C2C12 myoblasts to form larger myotubes upon differentiation (von Maltzahn et al. 2012, Bentzinger et al. 2014), through the up-regulation of MyoD (Tajbakhsh et al. 1998). On these bases, our results support the hypothesis that HIF-1 α plays a critical role in activating myogenesis through the *non-canonical Wnt pathway*.

To further validate our hypothesis, we tested whether an inhibition of HIF-1 α had any effect on myoblast differentiation. Therefore, HIF-1 α silencing was performed in C2C12 and the effects on skeletal muscle differentiation were evaluated. Results showed that the inhibition of HIF-1 α caused a marked reduction of WNT7a protein accumulation, when cells were subjected to 1% O₂ for 24 hours, supporting the involvement of *Wnt non-canonical pathway*. Moreover, HIF-1 α silencing

caused a down-regulation of MyoD nuclear translocation. To further investigate the role of HIF-1 α during skeletal muscle differentiation, we cultured HIF-1 α silenced cells for 24 hours in 1% O₂, and then induced them to differentiate under normoxic conditions. Results showed that silencing of HIF-1 α strongly reduced the differentiation process, as compared to controls, inducing a marked decrease of Myogenin and MHC expression, ultimately leading to a reduction of both fusion and differentiation indexes. Finally, to clarify the link between HIF-1 α activation and myogenesis, we further investigated the involvement of *Wnt non-canonical pathway* in the differentiation process. Along this line, it was previously demonstrated that an up-regulation of WNT7a induces hypertrophy in C2C12 (Tajbakhsh et al. 1998, von Maltzahn et al. 2013), thus already suggesting a possible involvement in the process. Therefore, to test whether the activation of the *Wnt non-canonical pathway* is required for HIF-1 α -induced activation of myogenesis, we chemically inhibited WNT during a 24 hours hypoxic pre-treatment. To this purpose, myoblasts were cultured for 24 hours under hypoxia in presence of 40 μ M XAV939, a chemical inhibitor of WNT that decreases β -catenin signaling through an up-regulation of Axin2 (Huang et al. 2009), and then induced myoblasts to differentiate under normoxia without the inhibitor. Results showed that treatment with XAV939 strongly reduced the differentiation process, with a marked reduction of MyoD nuclear localization and a decrease of Myogenin and MHC expression levels, eventually leading to the decrease of both fusion and differentiation indexes. Interestingly, it was previously reported that inhibition of WNT under normoxia caused an inhibition of the differentiation process (Abraham 2016), supporting the notion that the activation of WNT caused by hypoxia, could be only partially counteracted by the inhibitor, leading to some, yet limited differentiation. Overall, our results supported the hypothesis that hypoxia decreases the ubiquitination/degradation of HIF1 α and induces its activation (Groulx and Lee 2002), promoting skeletal muscle hypertrophy, through the action of the *Wnt non-canonical pathway*.

To better understand the link between HIF-1 α activation and WNT7a expression, a luciferase assay, under the control of WNT7a promoter, was designed. In order to investigate the role of HIF-1 α in the activation of WNT7a, we decided to perform the experiments in both physical and chemical hypoxia culture conditions. We observed that in both conditions the activation of HIF-1 α determined a considerable increase of the luciferase signal, which turned out to be directly proportional to WNT7a promoter stimulation, confirming the regulatory role played by HIF-1 α in the activation of WNT7a gene expression. Interestingly, it has been previously demonstrated that HIF-1 α is able to bind WNT7a in a model of oligodendrocytes (Yuen et al. 2014). Therefore, to confirm their direct interaction also in our cellular model, we decided to perform a ChIP assay in the presence of 1% O₂ to achieve preliminary results in physical hypoxia, but without any alterations induced by the

chemical treatment. In particular, we identified two possible binding sequences of HIF-1 α on WNT7a promoter, characterized by the presence of HRE sequences. The relevance of this finding is extremely important because HIF-1 α can become a new therapeutic target to induce the up-regulation of WNT7a, promoting the hypertrophy in skeletal muscle.

In summary, our results support that a transient activation of HIF-1 α is fundamental to activate the regeneration process which occurs in skeletal muscle. In particular, IOX2 and FG-4592, two PHDs inhibitors deeply used in several studies and one of them already employed in clinical trial phase 3, are able to mimic the effects on myogenesis obtained by 1% O₂, promoting the accumulation of MyoD into the nuclei and the formation of hypertrophic myotubes. Moreover, we define HIF-1 α as a new possible candidate to induce the activation of WNT7a, which characterized the hypertrophic phenotype of the skeletal muscle. Clearly, the next step would be to assess if our findings could be also activated *in vivo* in an animal model. In fact, if these results will be confirmed also *in vivo*, it might be envisioned to pharmacologically activate HIF-1 α , which has been already shown to be safe and feasible (Kim 2003, Mole 2009, Bentzinger 2014), to further activate muscle regeneration after an injury or a chronic degenerative disease. Further studies in this direction are currently ongoing in our laboratories and will be extended beyond this thesis work.

Bibliography

In Vitro Cell Dev Biol Anim **52**(9): 935-941.(9): 935-941.

Allbrook, D. B., et al. (1971). "Population of muscle satellite cells in relation to age and mitotic activity." Pathology **3**(3): 223-243.

Allen, D. L., et al. (2001). "Different pathways regulate expression of the skeletal myosin heavy chain genes." J Biol Chem **276**(47): 43524-43533.

Almeida, C. F., et al. (2016). "Muscle Satellite Cells: Exploring the Basic Biology to Rule Them." Stem Cells Int **2016**: 1078686.

Amthor, H., et al. (1999). "A molecular mechanism enabling continuous embryonic muscle growth - a balance between proliferation and differentiation." Development **126**(5): 1041-1053.

Anakwe, K., et al. (2003). "Wnt signalling regulates myogenic differentiation in the developing avian wing." Development **130**(15): 3503-3514.

Aulehla, A. and O. Pourquie (2010). "Signaling gradients during paraxial mesoderm development." Cold Spring Harb Perspect Biol **2**(2): a000869.

Bao, W., et al. (2010). "Chronic inhibition of hypoxia-inducible factor prolyl 4-hydroxylase improves ventricular performance, remodeling, and vascularity after myocardial infarction in the rat." J Cardiovasc Pharmacol **56**(2): 147-155.

Benezra, R., et al. (1990). "The protein Id: a negative regulator of helix-loop-helix DNA binding proteins." Cell **61**(1): 49-59.

Bentzinger, C. F., et al. (2014). "Wnt7a stimulates myogenic stem cell motility and engraftment resulting in improved muscle strength." J Cell Biol **205**(1): 97-111.

Bentzinger, C. F., et al. (2012). "Building muscle: molecular regulation of myogenesis." Cold Spring Harb Perspect Biol **4**(2).

Berkes, C. A. and S. J. Tapscott (2005). "MyoD and the transcriptional control of myogenesis." Semin Cell Dev Biol **16**(4-5): 585-595.

Bernard, P., et al. (2008). "Wnt4 inhibits beta-catenin/TCF signalling by redirecting beta-catenin to the cell membrane." Biol Cell **100**(3): 167-177.

Bernhardt, W. M., et al. (2010). "Inhibition of prolyl hydroxylases increases erythropoietin production in ESRD." J Am Soc Nephrol **21**(12): 2151-2156.

Berra, E., et al. (2003). "HIF prolyl-hydroxylase 2 is the key oxygen sensor setting low steady-state levels of HIF-1alpha in normoxia." EMBO J **22**(16): 4082-4090.

Bischoff, R. and C. Heintz (1994). "Enhancement of skeletal muscle regeneration." Dev Dyn **201**(1): 41-54.

- Bismuth, K. and F. Relaix (2010). "Genetic regulation of skeletal muscle development." Exp Cell Res **316**(18): 3081-3086.
- Black, B. L., et al. (1998). "Multiple roles for the MyoD basic region in transmission of transcriptional activation signals and interaction with MEF2." Mol Cell Biol **18**(1): 69-77.
- Braun, T., et al. (1992). "Targeted inactivation of the muscle regulatory gene Myf-5 results in abnormal rib development and perinatal death." Cell **71**(3): 369-382.
- Brembeck, F. H., et al. (2006). "Balancing cell adhesion and Wnt signaling, the key role of beta-catenin." Curr Opin Genet Dev **16**(1): 51-59.
- Bruick, R. K. and S. L. McKnight (2001). "A conserved family of prolyl-4-hydroxylases that modify HIF." Science **294**(5545): 1337-1340.
- Buckingham, M. (2001). "Skeletal muscle formation in vertebrates." Curr Opin Genet Dev **11**(4): 440-448.
- Carmeliet, P., et al. (1998). "Role of HIF-1alpha in hypoxia-mediated apoptosis, cell proliferation and tumour angiogenesis." Nature **394**(6692): 485-490.
- Cervera, A. M., et al. (2006). "An alternatively spliced transcript of the PHD3 gene retains prolyl hydroxylase activity." Cancer Lett **233**(1): 131-138.
- Chaillou, T., et al. (2014). "Effect of hypoxia exposure on the recovery of skeletal muscle phenotype during regeneration." Mol Cell Biochem **390**(1-2): 31-40.
- Chaillou, T. and J. T. Lanner (2016). "Regulation of myogenesis and skeletal muscle regeneration: effects of oxygen levels on satellite cell activity." FASEB J **30**(12): 3929-3941.
- Chan, M. C., et al. (2015). "Potent and Selective Triazole-Based Inhibitors of the Hypoxia-Inducible Factor Prolyl-Hydroxylases with Activity in the Murine Brain." PLoS One **10**(7): e0132004.
- Charge, S. B. and M. A. Rudnicki (2004). "Cellular and molecular regulation of muscle regeneration." Physiol Rev **84**(1): 209-238.
- Cheng, S., et al. (2017). "Conditional Deletion of the Phd2 Gene in Articular Chondrocytes Accelerates Differentiation and Reduces Articular Cartilage Thickness." Sci Rep **7**: 45408.
- Chowdhury, R., et al. (2013). "Selective small molecule probes for the hypoxia inducible factor (HIF) prolyl hydroxylases." ACS Chem Biol **8**(7): 1488-1496.
- Christ, B. and C. P. Ordahl (1995). "Early stages of chick somite development." Anat Embryol (Berl) **191**(5): 381-396.
- Ciciliot, S. and S. Schiaffino (2010). "Regeneration of mammalian skeletal muscle. Basic mechanisms and clinical implications." Curr Pharm Des **16**(8): 906-914.

- Cirillo, F., et al. (2017). "Activation of the hypoxia-inducible factor 1alpha promotes myogenesis through the noncanonical Wnt pathway, leading to hypertrophic myotubes." FASEB J.
- Corcoran, A. and J. J. O'Connor (2013). "Hypoxia-inducible factor signalling mechanisms in the central nervous system." Acta Physiol (Oxf) **208**(4): 298-310.
- De, A. (2011). "Wnt/Ca²⁺ signaling pathway: a brief overview." Acta Biochim Biophys Sin (Shanghai) **43**(10): 745-756.
- Di Carlo, A., et al. (2004). "Hypoxia inhibits myogenic differentiation through accelerated MyoD degradation." J Biol Chem **279**(16): 16332-16338.
- Dodou, E., et al. (2003). "mef2c is activated directly by myogenic basic helix-loop-helix proteins during skeletal muscle development in vivo." Mech Dev **120**(9): 1021-1032.
- Epstein, A. C., et al. (2001). "C. elegans EGL-9 and mammalian homologs define a family of dioxygenases that regulate HIF by prolyl hydroxylation." Cell **107**(1): 43-54.
- Favier, F. B., et al. (2015). "HIF-1-driven skeletal muscle adaptations to chronic hypoxia: molecular insights into muscle physiology." Cell Mol Life Sci **72**(24): 4681-4696.
- Favier, F. B., et al. (2016). "Endurance training prevents negative effects of the hypoxia mimetic dimethylxylglycine on cardiac and skeletal muscle function." J Appl Physiol (1985) **120**(4): 455-463.
- Ferri, P., et al. (2009). "Expression and subcellular localization of myogenic regulatory factors during the differentiation of skeletal muscle C2C12 myoblasts." J Cell Biochem **108**(6): 1302-1317.
- Fraisl, P., et al. (2009). "Inhibition of oxygen sensors as a therapeutic strategy for ischaemic and inflammatory disease." Nat Rev Drug Discov **8**(2): 139-152.
- Goulding, M., et al. (1994). "Regulation of Pax-3 expression in the dermomyotome and its role in muscle development." Development **120**(4): 957-971.
- Greer, S. N., et al. (2012). "The updated biology of hypoxia-inducible factor." EMBO J **31**(11): 2448-2460.
- Groulx, I. and S. Lee (2002). "Oxygen-dependent ubiquitination and degradation of hypoxia-inducible factor requires nuclear-cytoplasmic trafficking of the von Hippel-Lindau tumor suppressor protein." Mol Cell Biol **22**(15): 5319-5336.
- Gunaratnam, L. and J. V. Bonventre (2009). "HIF in kidney disease and development." J Am Soc Nephrol **20**(9): 1877-1887.
- Haase, V. H. (2009). "The VHL tumor suppressor: master regulator of HIF." Curr Pharm Des **15**(33): 3895-3903.
- Hara, S., et al. (2001). "Expression and characterization of hypoxia-inducible factor (HIF)-3alpha in human kidney: suppression of HIF-mediated gene expression by HIF-3alpha." Biochem Biophys Res Commun **287**(4): 808-813.

- Hart, M. L., et al. (2011). "Hypoxia-inducible factor-1alpha-dependent protection from intestinal ischemia/reperfusion injury involves ecto-5'-nucleotidase (CD73) and the A2B adenosine receptor." J Immunol **186**(7): 4367-4374.
- Hasty, P., et al. (1993). "Muscle deficiency and neonatal death in mice with a targeted mutation in the myogenin gene." Nature **364**(6437): 501-506.
- Hausinger, R. P. (2004). "FeII/alpha-ketoglutarate-dependent hydroxylases and related enzymes." Crit Rev Biochem Mol Biol **39**(1): 21-68.
- Hewitson, K. S., et al. (2004). "Modulating the hypoxia-inducible factor signaling pathway: applications from cardiovascular disease to cancer." Curr Pharm Des **10**(8): 821-833.
- Heyman, S. N., et al. (2016). "Adaptive response to hypoxia and remote ischaemia pre-conditioning: a new hypoxia-inducible factors era in clinical medicine." Acta Physiol (Oxf) **216**(4): 395-406.
- Heyman, S. N., et al. (2011). "Hypoxia-inducible factors and the prevention of acute organ injury." Crit Care **15**(2): 209.
- Hirota, K. and G. L. Semenza (2006). "Regulation of angiogenesis by hypoxia-inducible factor 1." Crit Rev Oncol Hematol **59**(1): 15-26.
- Hirsila, M., et al. (2003). "Characterization of the human prolyl 4-hydroxylases that modify the hypoxia-inducible factor." J Biol Chem **278**(33): 30772-30780.
- Hon, W. C., et al. (2002). "Structural basis for the recognition of hydroxyproline in HIF-1 alpha by pVHL." Nature **417**(6892): 975-978.
- Howald, H. and H. Hoppeler (2003). "Performing at extreme altitude: muscle cellular and subcellular adaptations." Eur J Appl Physiol **90**(3-4): 360-364.
- Huang, L. E., et al. (1996). "Activation of hypoxia-inducible transcription factor depends primarily upon redox-sensitive stabilization of its alpha subunit." J Biol Chem **271**(50): 32253-32259.
- Huang, L. E., et al. (1998). "Regulation of hypoxia-inducible factor 1alpha is mediated by an O2-dependent degradation domain via the ubiquitin-proteasome pathway." Proc Natl Acad Sci U S A **95**(14): 7987-7992.
- Huang, S. M., et al. (2009). "Tankyrase inhibition stabilizes axin and antagonizes Wnt signalling." Nature **461**(7264): 614-620.
- Ingham, P. W. and A. P. McMahon (2001). "Hedgehog signaling in animal development: paradigms and principles." Genes Dev **15**(23): 3059-3087.
- Iyer, N. V., et al. (1998). "Cellular and developmental control of O2 homeostasis by hypoxia-inducible factor 1 alpha." Genes Dev **12**(2): 149-162.
- Jaakkola, P., et al. (2001). "Targeting of HIF-alpha to the von Hippel-Lindau ubiquitylation complex by O2-regulated prolyl hydroxylation." Science **292**(5516): 468-472.

- Janda, C. Y., et al. (2012). "Structural basis of Wnt recognition by Frizzled." Science **337**(6090): 59-64.
- Jash, S. and S. Adhya (2015). "Effects of Transient Hypoxia versus Prolonged Hypoxia on Satellite Cell Proliferation and Differentiation In Vivo." Stem Cells Int **2015**: 961307.
- Jiang, B. H., et al. (1997). "V-SRC induces expression of hypoxia-inducible factor 1 (HIF-1) and transcription of genes encoding vascular endothelial growth factor and enolase 1: involvement of HIF-1 in tumor progression." Cancer Res **57**(23): 5328-5335.
- Jostes, B., et al. (1990). "The murine paired box gene, Pax7, is expressed specifically during the development of the nervous and muscular system." Mech Dev **33**(1): 27-37.
- Kaelin, W. G., Jr. and P. J. Ratcliffe (2008). "Oxygen sensing by metazoans: the central role of the HIF hydroxylase pathway." Mol Cell **30**(4): 393-402.
- Kardon, G., et al. (2002). "Pax3 and Dach2 positive regulation in the developing somite." Dev Dyn **224**(3): 350-355.
- Karuppagounder, S. S. and R. R. Ratan (2012). "Hypoxia-inducible factor prolyl hydroxylase inhibition: robust new target or another big bust for stroke therapeutics?" J Cereb Blood Flow Metab **32**(7): 1347-1361.
- Kiefer, J. C. and S. D. Hauschka (2001). "Myf-5 is transiently expressed in nonmuscle mesoderm and exhibits dynamic regional changes within the presegmented mesoderm and somites I-IV." Dev Biol **232**(1): 77-90.
- Kikuchi, A., et al. (2011). "New insights into the mechanism of Wnt signaling pathway activation." Int Rev Cell Mol Biol **291**: 21-71.
- Kim, J. W., et al. (2006). "HIF-1-mediated expression of pyruvate dehydrogenase kinase: a metabolic switch required for cellular adaptation to hypoxia." Cell Metab **3**(3): 177-185.
- Kim, M., et al. (2015). "The combination of ursolic acid and leucine potentiates the differentiation of C2C12 murine myoblasts through the mTOR signaling pathway." Int J Mol Med **35**(3): 755-762.
- Kirino, T. (2002). "Ischemic tolerance." J Cereb Blood Flow Metab **22**(11): 1283-1296.
- Klose, R. J. and Y. Zhang (2007). "Regulation of histone methylation by demethylination and demethylation." Nat Rev Mol Cell Biol **8**(4): 307-318.
- Koning, M., et al. (2011). "Hypoxia promotes proliferation of human myogenic satellite cells: a potential benefactor in tissue engineering of skeletal muscle." Tissue Eng Part A **17**(13-14): 1747-1758.
- Kook, S. H., et al. (2008). "Hypoxia affects positively the proliferation of bovine satellite cells and their myogenic differentiation through up-regulation of MyoD." Cell Biol Int **32**(8): 871-878.

- Krishnamachary, B., et al. (2003). "Regulation of colon carcinoma cell invasion by hypoxia-inducible factor 1." Cancer Res **63**(5): 1138-1143.
- Kuang, S., et al. (2008). "Niche regulation of muscle satellite cell self-renewal and differentiation." Cell Stem Cell **2**(1): 22-31.
- Lassar, A. B., et al. (1994). "Regulatory mechanisms that coordinate skeletal muscle differentiation and cell cycle withdrawal." Curr Opin Cell Biol **6**(6): 788-794.
- Lepper, C. and C. M. Fan (2010). "Inducible lineage tracing of Pax7-descendant cells reveals embryonic origin of adult satellite cells." Genesis **48**(7): 424-436.
- Levy, A. P., et al. (1995). "Regulation of vascular endothelial growth factor in cardiac myocytes." Circ Res **76**(5): 758-766.
- Li, X., et al. (2011). "Iron chelation and neuroprotection in neurodegenerative diseases." J Neural Transm (Vienna) **118**(3): 473-477.
- Liu, C., et al. (2002). "Control of beta-catenin phosphorylation/degradation by a dual-kinase mechanism." Cell **108**(6): 837-847.
- Liu, W., et al. (2012). "Hypoxia promotes satellite cell self-renewal and enhances the efficiency of myoblast transplantation." Development **139**(16): 2857-2865.
- Loenarz, C. and C. J. Schofield (2008). "Expanding chemical biology of 2-oxoglutarate oxygenases." Nat Chem Biol **4**(3): 152-156.
- Logan, C. Y. and R. Nusse (2004). "The Wnt signaling pathway in development and disease." Annu Rev Cell Dev Biol **20**: 781-810.
- Ludolph, D. C. and S. F. Konieczny (1995). "Transcription factor families: muscling in on the myogenic program." FASEB J **9**(15): 1595-1604.
- Mahon, P. C., et al. (2001). "FIH-1: a novel protein that interacts with HIF-1alpha and VHL to mediate repression of HIF-1 transcriptional activity." Genes Dev **15**(20): 2675-2686.
- Majmundar, A. J., et al. (2015). "HIF modulation of Wnt signaling regulates skeletal myogenesis in vivo." Development **142**(14): 2405-2412.
- Majmundar, A. J., et al. (2012). "O₂ regulates skeletal muscle progenitor differentiation through phosphatidylinositol 3-kinase/AKT signaling." Mol Cell Biol **32**(1): 36-49.
- Makino, Y., et al. (2002). "Inhibitory PAS domain protein (IPAS) is a hypoxia-inducible splicing variant of the hypoxia-inducible factor-3alpha locus." J Biol Chem **277**(36): 32405-32408.
- Mason, S. and R. S. Johnson (2007). "The role of HIF-1 in hypoxic response in the skeletal muscle." Adv Exp Med Biol **618**: 229-244.
- Mauro, A. (1961). "Satellite cell of skeletal muscle fibers." J Biophys Biochem Cytol **9**: 493-495.

- Maxwell, P. H. and K. U. Eckardt (2016). "HIF prolyl hydroxylase inhibitors for the treatment of renal anaemia and beyond." Nat Rev Nephrol **12**(3): 157-168.
- Maynard, M. A., et al. (2003). "Multiple splice variants of the human HIF-3 alpha locus are targets of the von Hippel-Lindau E3 ubiquitin ligase complex." J Biol Chem **278**(13): 11032-11040.
- Mazumdar, J., et al. (2010). "O₂ regulates stem cells through Wnt/beta-catenin signalling." Nat Cell Biol **12**(10): 1007-1013.
- Milkiewicz, M., et al. (2004). "Inhibition of endogenous HIF inactivation induces angiogenesis in ischaemic skeletal muscles of mice." J Physiol **560**(Pt 1): 21-26.
- Minamishima, Y. A., et al. (2008). "Somatic inactivation of the PHD2 prolyl hydroxylase causes polycythemia and congestive heart failure." Blood **111**(6): 3236-3244.
- Morrison, S. J. and A. C. Spradling (2008). "Stem cells and niches: mechanisms that promote stem cell maintenance throughout life." Cell **132**(4): 598-611.
- Munsterberg, A. E., et al. (1995). "Combinatorial signaling by Sonic hedgehog and Wnt family members induces myogenic bHLH gene expression in the somite." Genes Dev **9**(23): 2911-2922.
- Myllyharju, J. (2009). "HIF prolyl 4-hydroxylases and their potential as drug targets." Curr Pharm Des **15**(33): 3878-3885.
- Myllyharju, J. (2013). "Prolyl 4-hydroxylases, master regulators of the hypoxia response." Acta Physiol (Oxf) **208**(2): 148-165.
- Naya, F. J., et al. (1999). "Transcriptional activity of MEF2 during mouse embryogenesis monitored with a MEF2-dependent transgene." Development **126**(10): 2045-2052.
- Needleman, P., et al. (1986). "Arachidonic acid metabolism." Annu Rev Biochem **55**: 69-102.
- Niehrs, C. (2012). "The complex world of WNT receptor signalling." Nat Rev Mol Cell Biol **13**(12): 767-779.
- Niemi, H., et al. (2014). "HIF-1alpha and HIF-2alpha induce angiogenesis and improve muscle energy recovery." Eur J Clin Invest **44**(10): 989-999.
- Nunomiya, A., et al. (2016). "Activation of the hypoxia-inducible factor pathway induced by prolyl hydroxylase domain 2 deficiency enhances the effect of running training in mice." Acta Physiol (Oxf).
- O'Mahoney, J. V., et al. (1998). "Identification of a novel slow-muscle-fiber enhancer binding protein, MusTRD1." Mol Cell Biol **18**(11): 6641-6652.
- O'Rourke, J. F., et al. (1999). "Oxygen-regulated and transactivating domains in endothelial PAS protein 1: comparison with hypoxia-inducible factor-1alpha." J Biol Chem **274**(4): 2060-2071.
- Ogle, M. E., et al. (2012). "Inhibition of prolyl hydroxylases by dimethylxaloylglycine after stroke reduces ischemic brain injury and requires hypoxia inducible factor-1alpha." Neurobiol Dis **45**(2): 733-742.

- Olson, E. N. and W. H. Klein (1994). "bHLH factors in muscle development: dead lines and commitments, what to leave in and what to leave out." Genes Dev **8**(1): 1-8.
- Olson, E. N., et al. (1995). "Regulation of muscle differentiation by the MEF2 family of MADS box transcription factors." Dev Biol **172**(1): 2-14.
- Olson, E. N. and R. S. Williams (2000). "Calcineurin signaling and muscle remodeling." Cell **101**(7): 689-692.
- Ono, Y., et al. (2006). "Knockdown of hypoxia-inducible factor-1alpha by siRNA inhibits C2C12 myoblast differentiation." J Cell Biochem **98**(3): 642-649.
- Paltoglou, S. and B. J. Roberts (2007). "HIF-1alpha and EPAS ubiquitination mediated by the VHL tumour suppressor involves flexibility in the ubiquitination mechanism, similar to other RING E3 ligases." Oncogene **26**(4): 604-609.
- Parker, M. H., et al. (2003). "Looking back to the embryo: defining transcriptional networks in adult myogenesis." Nat Rev Genet **4**(7): 497-507.
- Pescador, N., et al. (2005). "Identification of a functional hypoxia-responsive element that regulates the expression of the egl nine homologue 3 (egln3/phd3) gene." Biochem J **390**(Pt 1): 189-197.
- Pong, K. (2004). "Ischaemic preconditioning: therapeutic implications for stroke?" Expert Opin Ther Targets **8**(2): 125-139.
- Pownall, M. E., et al. (2002). "Myogenic regulatory factors and the specification of muscle progenitors in vertebrate embryos." Annu Rev Cell Dev Biol **18**: 747-783.
- Provot, S. and E. Schipani (2007). "Fetal growth plate: a developmental model of cellular adaptation to hypoxia." Ann N Y Acad Sci **1117**: 26-39.
- Pugh, C. W., et al. (1997). "Activation of hypoxia-inducible factor-1; definition of regulatory domains within the alpha subunit." J Biol Chem **272**(17): 11205-11214.
- Rao, T. P. and M. Kuhl (2010). "An updated overview on Wnt signaling pathways: a prelude for more." Circ Res **106**(12): 1798-1806.
- Relaix, F., et al. (2005). "A Pax3/Pax7-dependent population of skeletal muscle progenitor cells." Nature **435**(7044): 948-953.
- Richardson, M. T., et al. (1995). "The value of ten common exercise tolerance test measures in predicting coronary disease in symptomatic females." Cardiology **86**(3): 243-248.
- Rudnicki, M. A., et al. (2008). "The molecular regulation of muscle stem cell function." Cold Spring Harb Symp Quant Biol **73**: 323-331.
- Rudnicki, M. A., et al. (1993). "MyoD or Myf-5 is required for the formation of skeletal muscle." Cell **75**(7): 1351-1359.

- Sato, N., et al. (2010). "Wnt inhibitor Dickkopf-1 as a target for passive cancer immunotherapy." Cancer Res **70**(13): 5326-5336.
- Scheerer, N., et al. (2013). "Myeloid hypoxia-inducible factor-1alpha is essential for skeletal muscle regeneration in mice." J Immunol **191**(1): 407-414.
- Schlessinger, K., et al. (2009). "Wnt signaling pathways meet Rho GTPases." Genes Dev **23**(3): 265-277.
- Schodel, J., et al. (2011). "High-resolution genome-wide mapping of HIF-binding sites by CHIP-seq." Blood **117**(23): e207-217.
- Schofield, C. J. and P. J. Ratcliffe (2004). "Oxygen sensing by HIF hydroxylases." Nat Rev Mol Cell Biol **5**(5): 343-354.
- Scholz, D., et al. (2003). "Angiogenesis and myogenesis as two facets of inflammatory post-ischemic tissue regeneration." Mol Cell Biochem **246**(1-2): 57-67.
- Seagroves, T. N., et al. (2001). "Transcription factor HIF-1 is a necessary mediator of the pasteur effect in mammalian cells." Mol Cell Biol **21**(10): 3436-3444.
- Seale, P. and M. A. Rudnicki (2000). "A new look at the origin, function, and "stem-cell" status of muscle satellite cells." Dev Biol **218**(2): 115-124.
- Semenza, G. L. (1996). "Transcriptional regulation by hypoxia-inducible factor 1 molecular mechanisms of oxygen homeostasis." Trends Cardiovasc Med **6**(5): 151-157.
- Semenza, G. L. (2010). "Oxygen homeostasis." Wiley Interdiscip Rev Syst Biol Med **2**(3): 336-361.
- Semenza, G. L. (2014). "Oxygen sensing, hypoxia-inducible factors, and disease pathophysiology." Annu Rev Pathol **9**: 47-71.
- Sen Banerjee, S., et al. (2012). "HIF-prolyl hydroxylases and cardiovascular diseases." Toxicol Mech Methods **22**(5): 347-358.
- Sethi, J. K. and A. Vidal-Puig (2010). "Wnt signalling and the control of cellular metabolism." Biochem J **427**(1): 1-17.
- Shi, X. and D. J. Garry (2006). "Muscle stem cells in development, regeneration, and disease." Genes Dev **20**(13): 1692-1708.
- Shin, J., et al. (2016). "Prolyl hydroxylase domain 2 deficiency promotes skeletal muscle fiber-type transition via a calcineurin/NFATc1-dependent pathway." Skelet Muscle **6**: 5.
- Sim, J. and R. S. Johnson (2014). "A whiter shade of gray: HIF and coordination of angiogenesis with postnatal myelination." Dev Cell **30**(2): 116-117.
- Summerbell, D. and P. W. Rigby (2000). "Transcriptional regulation during somitogenesis." Curr Top Dev Biol **48**: 301-318.

- Tajbakhsh, S., et al. (1998). "Differential activation of Myf5 and MyoD by different Wnts in explants of mouse paraxial mesoderm and the later activation of myogenesis in the absence of Myf5." Development **125**(21): 4155-4162.
- Tajbakhsh, S. and M. Buckingham (2000). "The birth of muscle progenitor cells in the mouse: spatiotemporal considerations." Curr Top Dev Biol **48**: 225-268.
- Takata, H., et al. (2007). "Involvement of Wnt4 signaling during myogenic proliferation and differentiation of skeletal muscle." Dev Dyn **236**(10): 2800-2807.
- Takeda, K., et al. (2006). "Placental but not heart defects are associated with elevated hypoxia-inducible factor alpha levels in mice lacking prolyl hydroxylase domain protein 2." Mol Cell Biol **26**(22): 8336-8346.
- Talmadge, R. J., et al. (1993). "Muscle fiber types and function." Curr Opin Rheumatol **5**(6): 695-705.
- Tanaka, S., et al. (2011). "Canonical Wnt signaling is involved in switching from cell proliferation to myogenic differentiation of mouse myoblast cells." J Mol Signal **6**: 12.
- Thom, R., et al. (2014). "Hypoxic induction of vascular endothelial growth factor (VEGF) and angiogenesis in muscle by truncated peroxisome proliferator-activated receptor gamma coactivator (PGC)-1alpha." J Biol Chem **289**(13): 8810-8817.
- Tian, Y. M., et al. (2006). "Characterization of different isoforms of the HIF prolyl hydroxylase PHD1 generated by alternative initiation." Biochem J **397**(1): 179-186.
- Verges, S., et al. (2015). "Hypoxic Conditioning as a New Therapeutic Modality." Front Pediatr **3**: 58.
- Vlaminck, B., et al. (2007). "Dual effect of echinomycin on hypoxia-inducible factor-1 activity under normoxic and hypoxic conditions." FEBS J **274**(21): 5533-5542.
- von Maltzahn, J., et al. (2011). "Wnt7a-Fzd7 signalling directly activates the Akt/mTOR anabolic growth pathway in skeletal muscle." Nat Cell Biol **14**(2): 186-191.
- von Maltzahn, J., et al. (2012). "Wnt signaling in myogenesis." Trends Cell Biol **22**(11): 602-609.
- von Maltzahn, J., et al. (2013). "A truncated Wnt7a retains full biological activity in skeletal muscle." Nat Commun **4**: 2869.
- Walters, E. H., et al. (2000). "MRF-4 exhibits fiber type- and muscle-specific pattern of expression in postnatal rat muscle." Am J Physiol Regul Integr Comp Physiol **278**(5): R1381-1384.
- Wang, G. L. and G. L. Semenza (1995). "Purification and characterization of hypoxia-inducible factor 1." J Biol Chem **270**(3): 1230-1237.
- Webb, J. D., et al. (2009). "Hypoxia, hypoxia-inducible factors (HIF), HIF hydroxylases and oxygen sensing." Cell Mol Life Sci **66**(22): 3539-3554.

- Weintraub, H. (1993). "The MyoD family and myogenesis: redundancy, networks, and thresholds." Cell **75**(7): 1241-1244.
- Weiss, A. and L. A. Leinwand (1996). "The mammalian myosin heavy chain gene family." Annu Rev Cell Dev Biol **12**: 417-439.
- Wenger, R. H. and M. Gassmann (1997). "Oxygen(es) and the hypoxia-inducible factor-1." Biol Chem **378**(7): 609-616.
- Wenger, R. H., et al. (2005). "Integration of oxygen signaling at the consensus HRE." Sci STKE **2005**(306): re12.
- Willam, C., et al. (2006). "HIF prolyl hydroxylases in the rat; organ distribution and changes in expression following hypoxia and coronary artery ligation." J Mol Cell Cardiol **41**(1): 68-77.
- Wilson-Rawls, J., et al. (1999). "Differential regulation of epaxial and hypaxial muscle development by paraxis." Development **126**(23): 5217-5229.
- Xie, H. C., et al. (2014). "Expression of HIF-1alpha and VEGF in skeletal muscle of plateau animals in response to hypoxic stress." Physiol Res **63**(6): 801-805.
- Yablonka-Reuveni, Z. and A. J. Rivera (1994). "Temporal expression of regulatory and structural muscle proteins during myogenesis of satellite cells on isolated adult rat fibers." Dev Biol **164**(2): 588-603.
- Yeoh, K. K., et al. (2013). "Dual-action inhibitors of HIF prolyl hydroxylases that induce binding of a second iron ion." Org Biomol Chem **11**(5): 732-745.
- Yoon, D., et al. (2006). "Hypoxia-inducible factor-1 deficiency results in dysregulated erythropoiesis signaling and iron homeostasis in mouse development." J Biol Chem **281**(35): 25703-25711.
- Yuen, T. J., et al. (2014). "Oligodendrocyte-encoded HIF function couples postnatal myelination and white matter angiogenesis." Cell **158**(2): 383-396.
- Yun, K. and B. Wold (1996). "Skeletal muscle determination and differentiation: story of a core regulatory network and its context." Curr Opin Cell Biol **8**(6): 877-889.
- Yun, Z., et al. (2005). "Adaptive myogenesis under hypoxia." Mol Cell Biol **25**(8): 3040-3055.
- Zhang, M. and I. S. McLennan (1998). "Primary myotubes preferentially mature into either the fastest or slowest muscle fibers." Dev Dyn **213**(1): 147-157.
- Zhou, W., et al. (2012). "HIF1alpha induced switch from bivalent to exclusively glycolytic metabolism during ESC-to-EpiSC/hESC transition." EMBO J **31**(9): 2103-2116.
- Zhu, Z. and J. B. Miller (1997). "MRF4 can substitute for myogenin during early stages of myogenesis." Dev Dyn **209**(2): 233-241.