

13

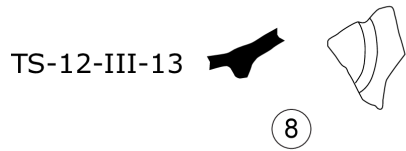

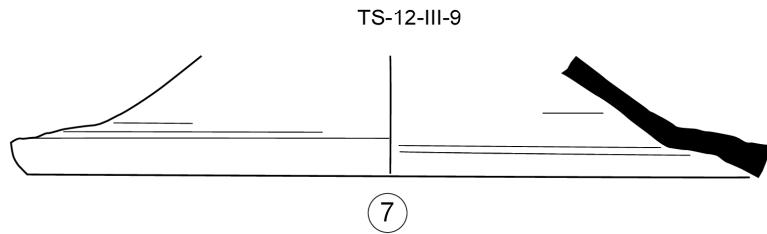

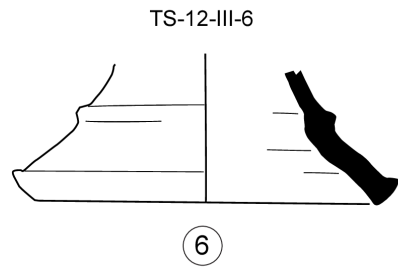
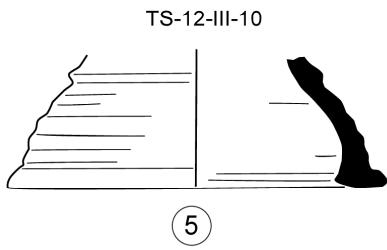
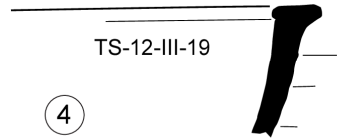
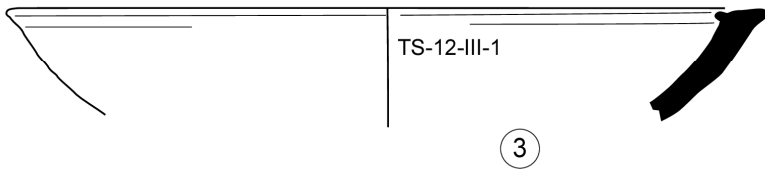
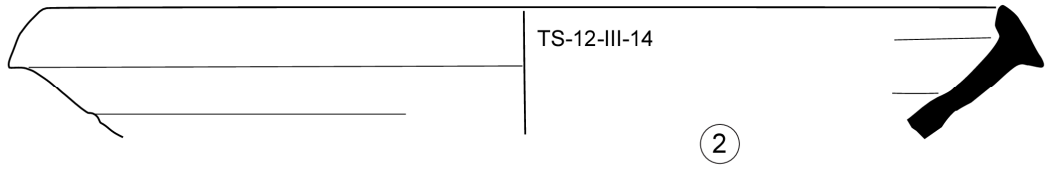
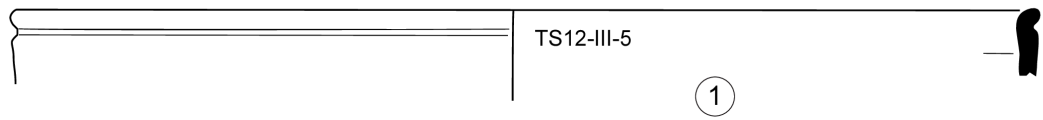
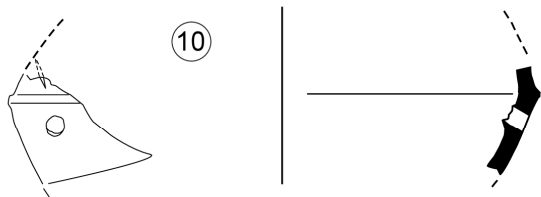
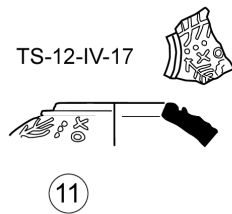
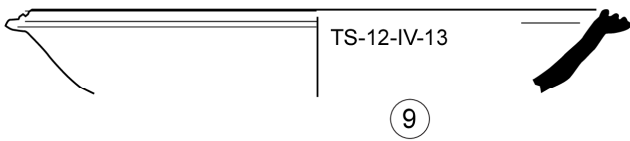
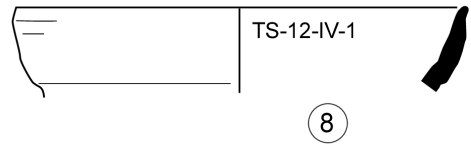
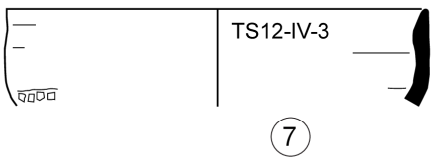
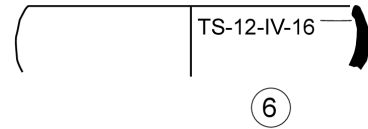
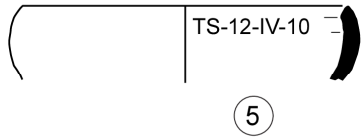
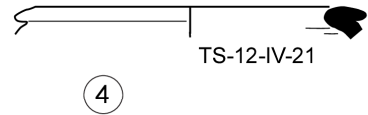
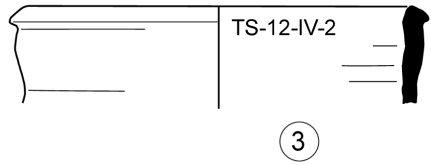
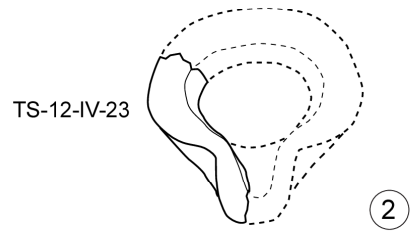
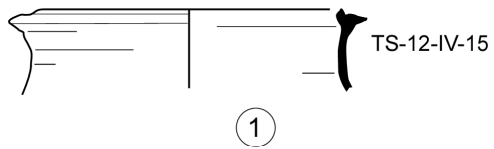

TS-12-V-92

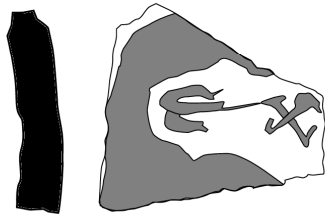

①

TS-12-V-69

TS-12-VII-64

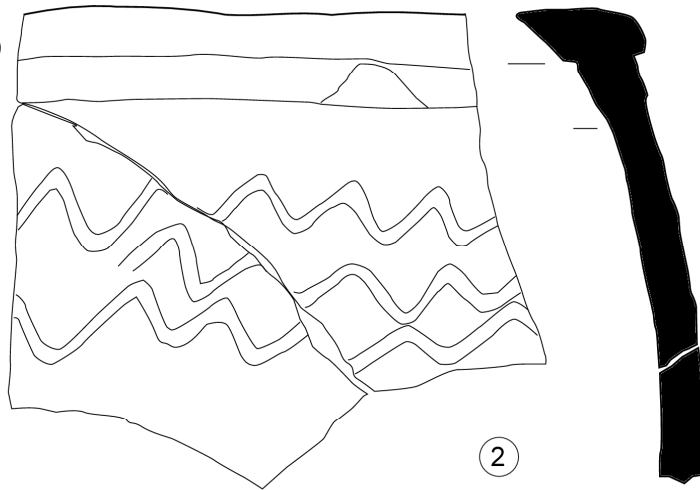

②

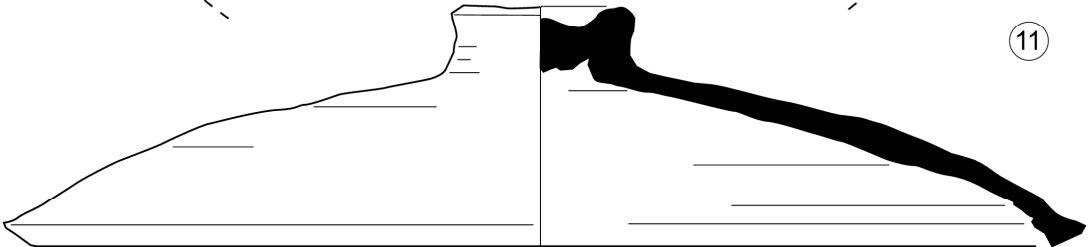
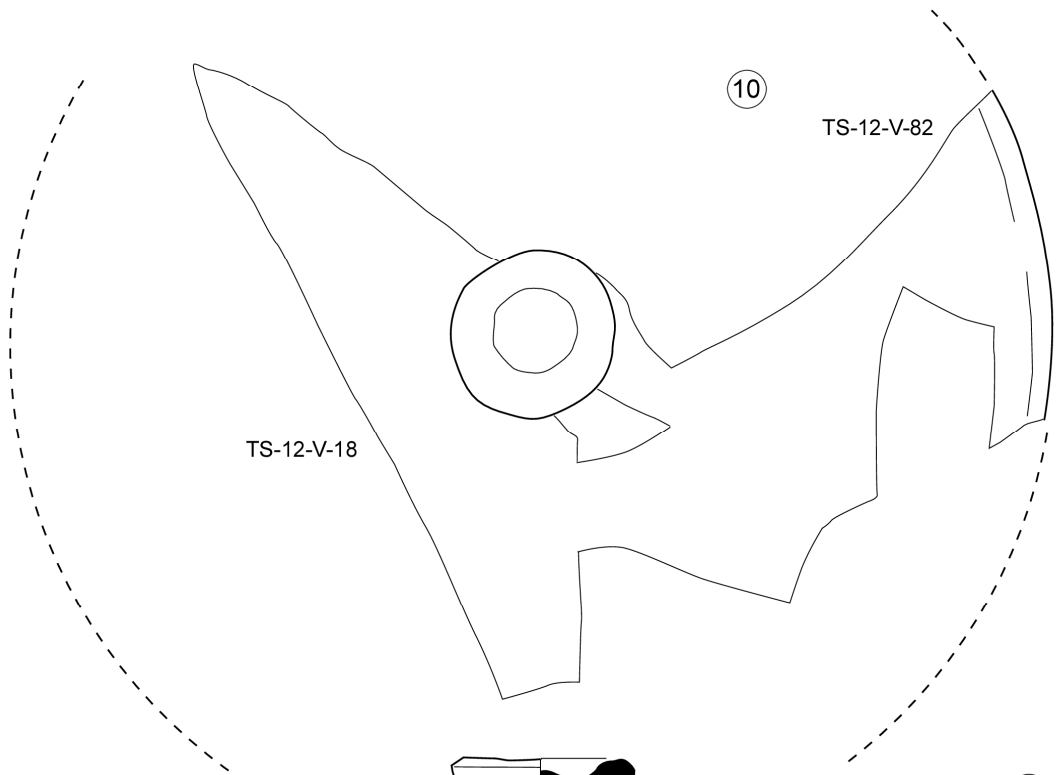
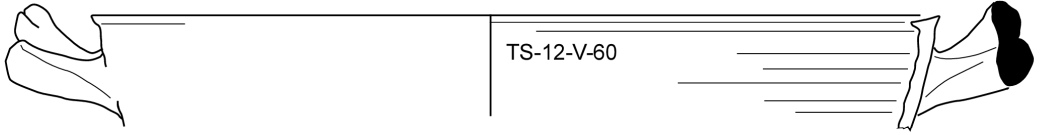
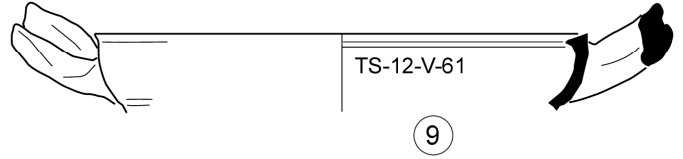
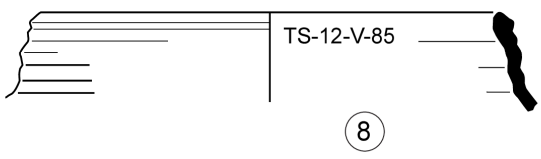
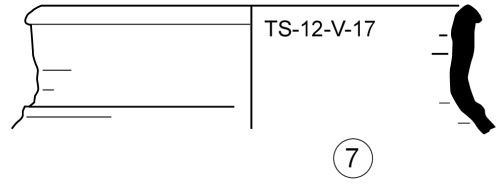
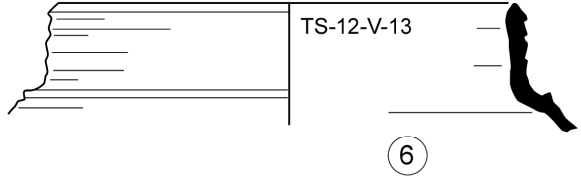
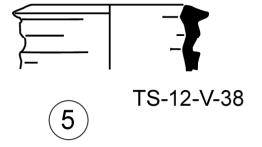
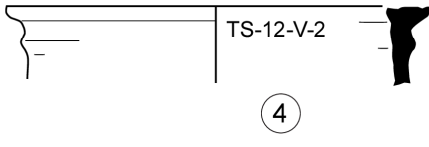
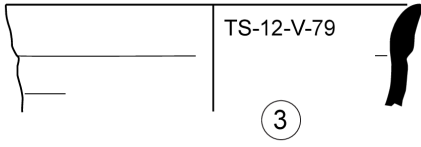

Tav.6 Trincea del Synthoronon. US5

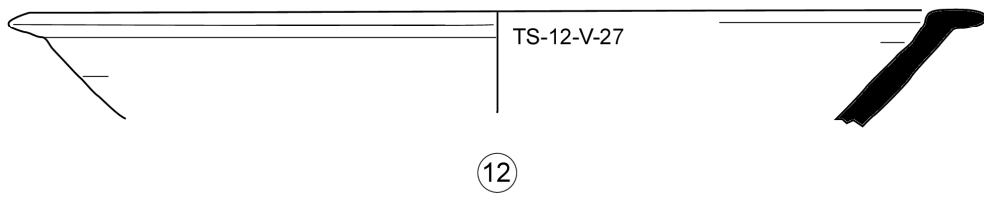

12

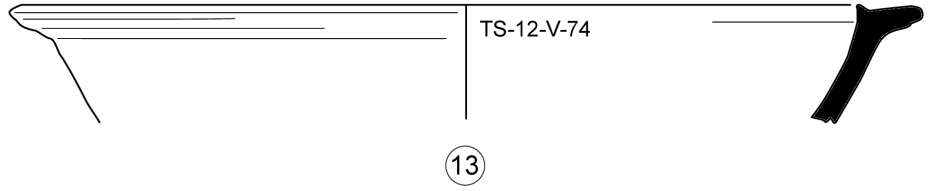

13

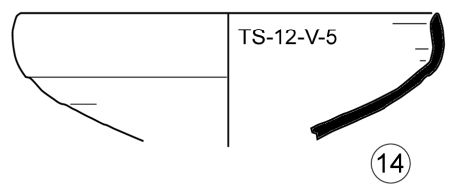

14

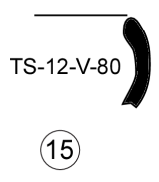

15

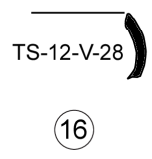

16

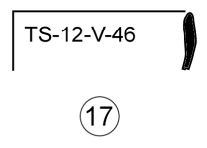

17

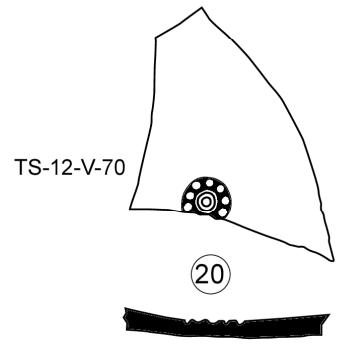

20

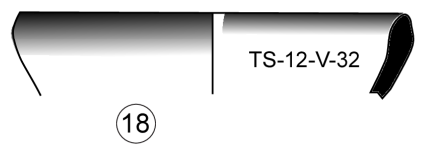

18

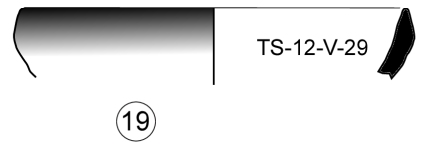

19

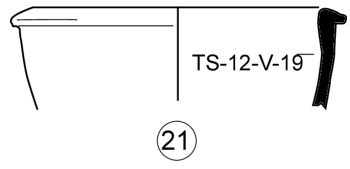

21

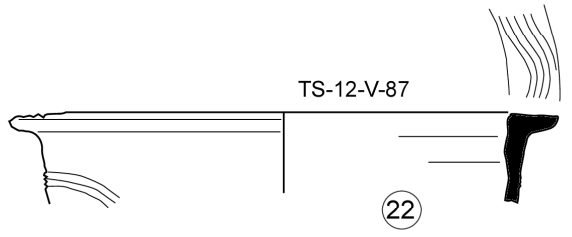

22

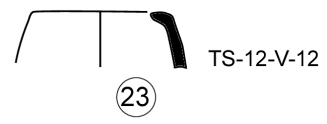

23

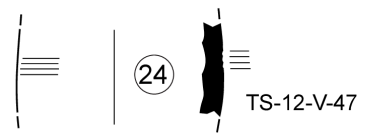

24

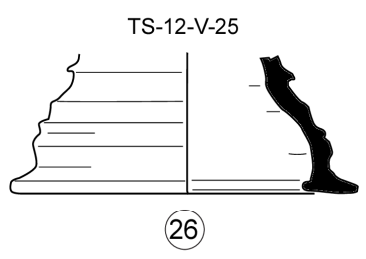

26

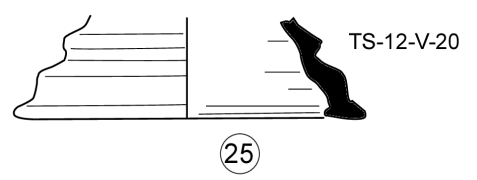

25

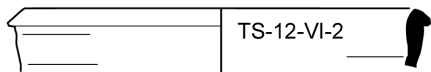

1

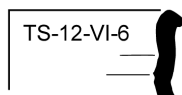

2

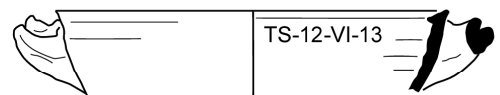

3

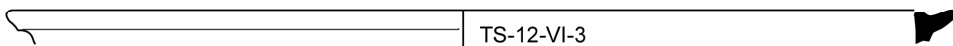

4

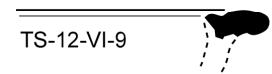

5

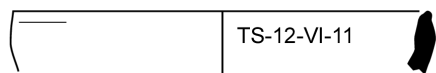

6

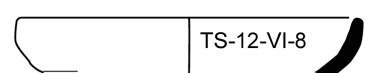

7

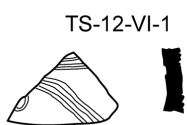

8

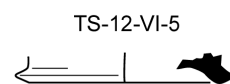

9

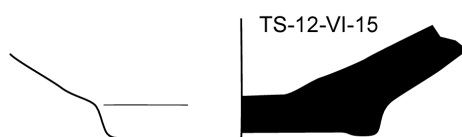

10

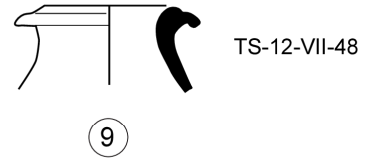
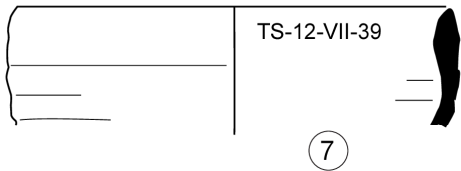
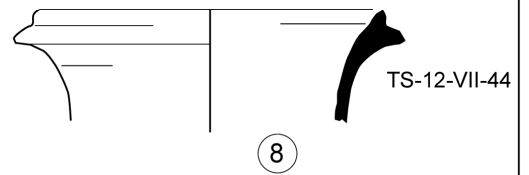
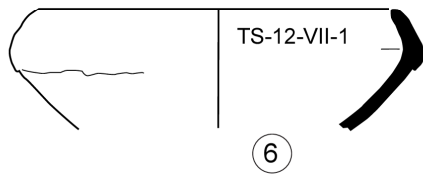
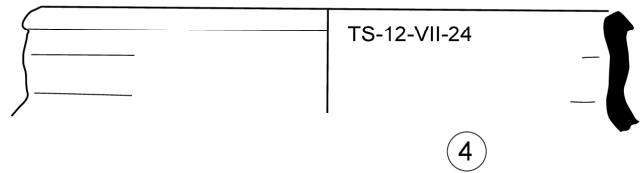
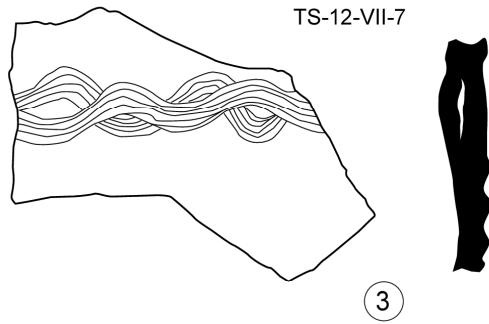
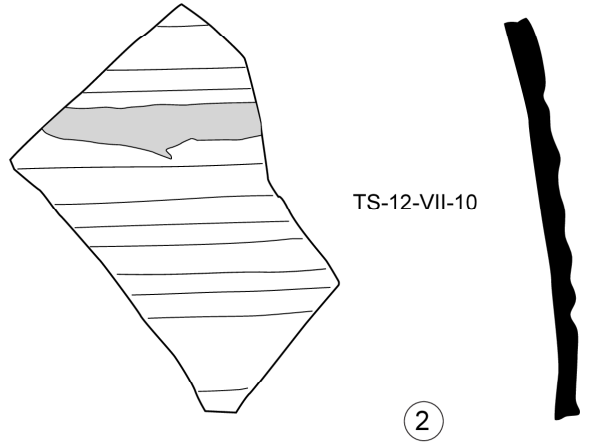
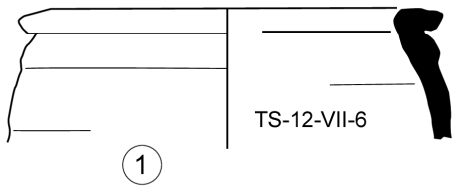

TS-12-VII-69

TS-12-VII-18

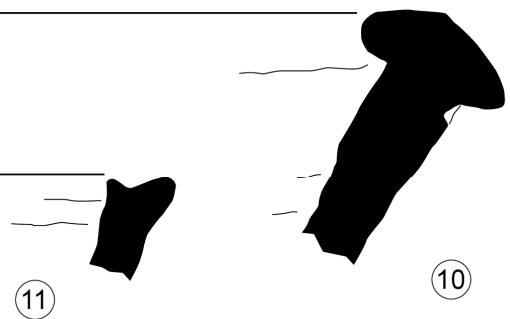

TS-12-VII-20

12

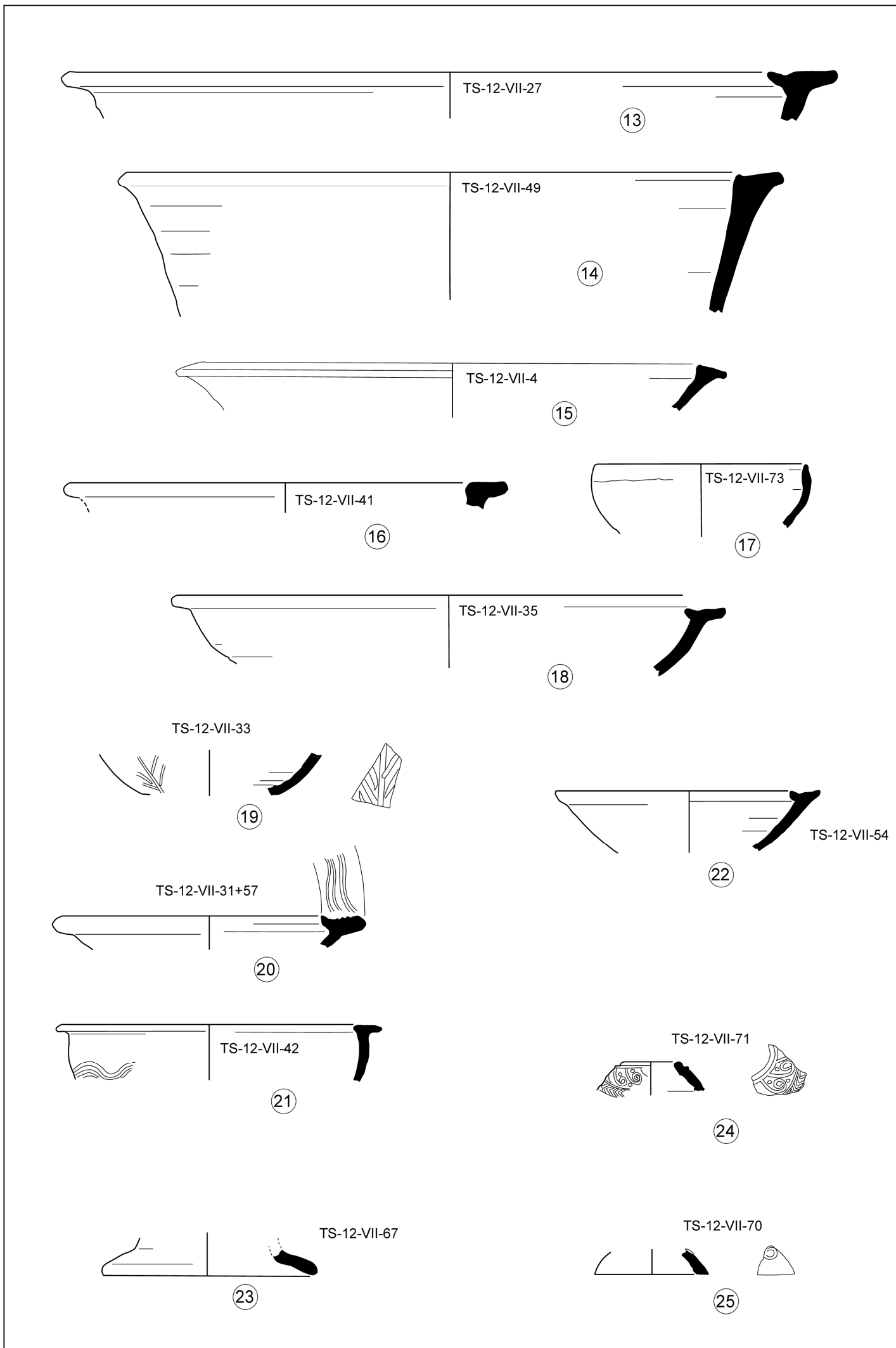

Tav.10 Trincea del Synthoronon. US7

TS12-V-96c

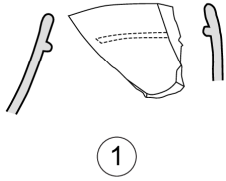

TS12-VII-82

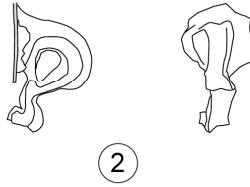

TS12-V-96b

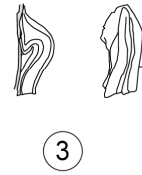

TS12-VII-82a

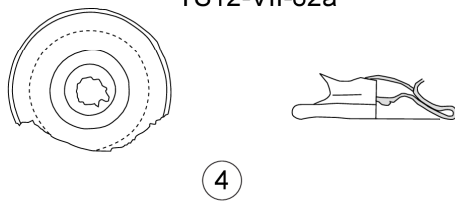

TS12-V-96

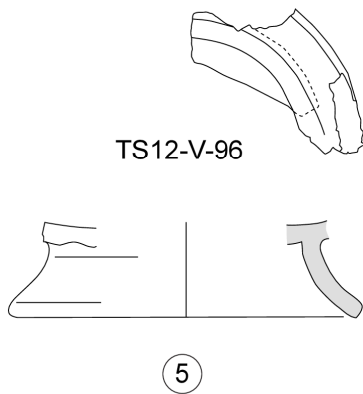

TS12-V-96d

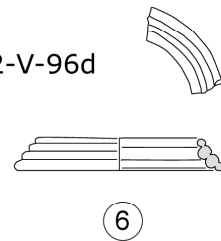

TS-12-II-51

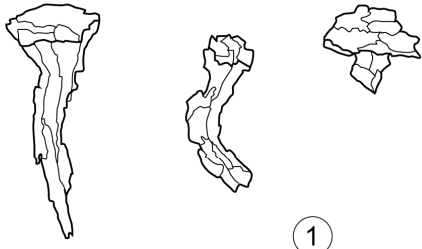

①

TE-12-I-8



②

TS-12-II-47



③

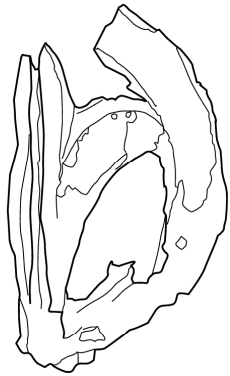
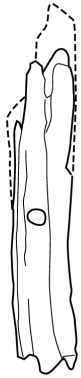

④

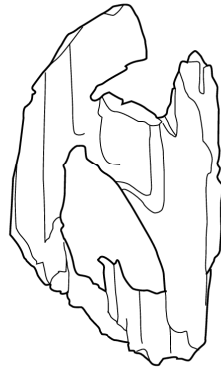

TS-12-VII-77





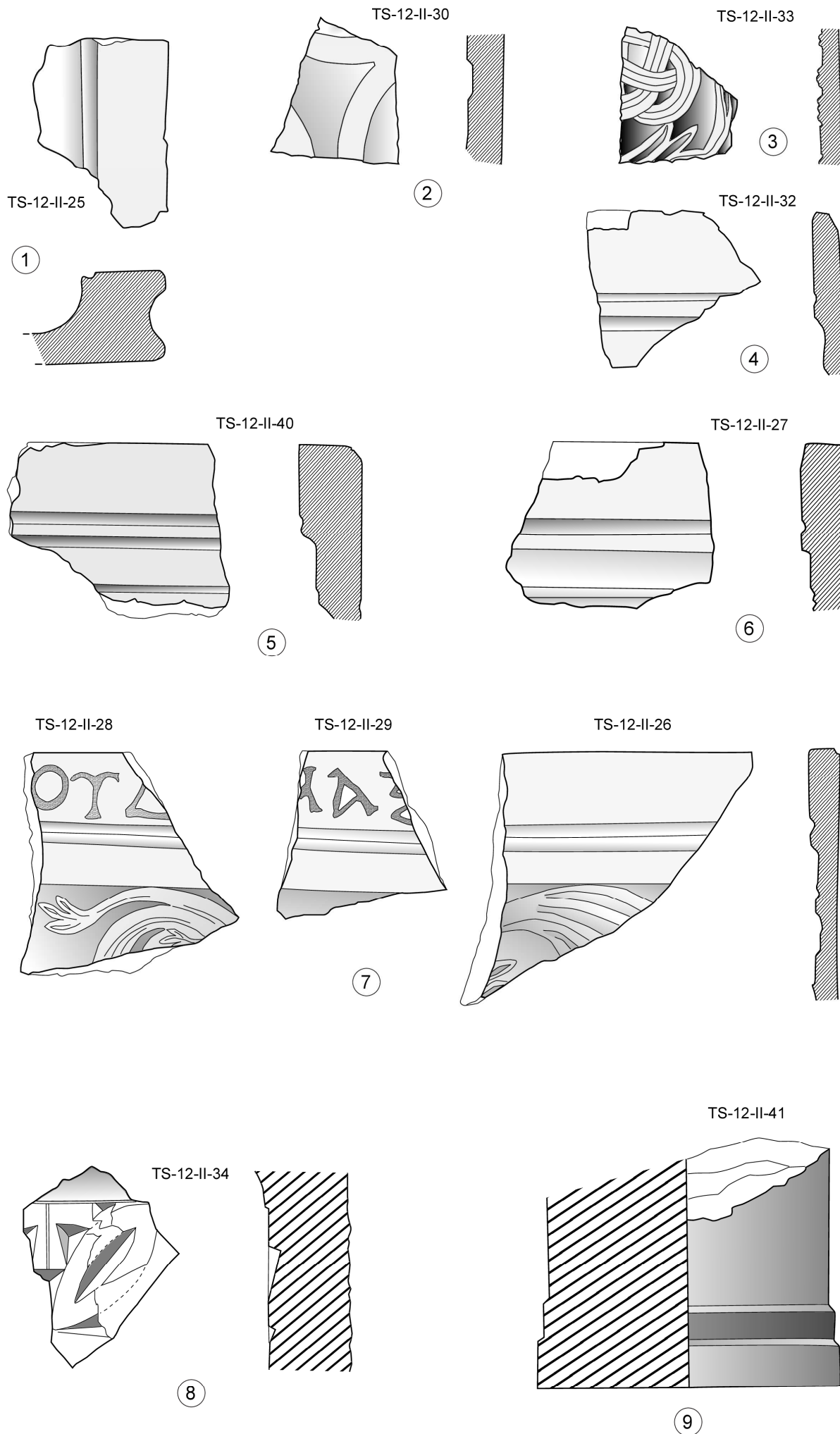

Tav.13 Trincea del Synthronon. Elementi architettonici marmorei

0 5 10 15 cm

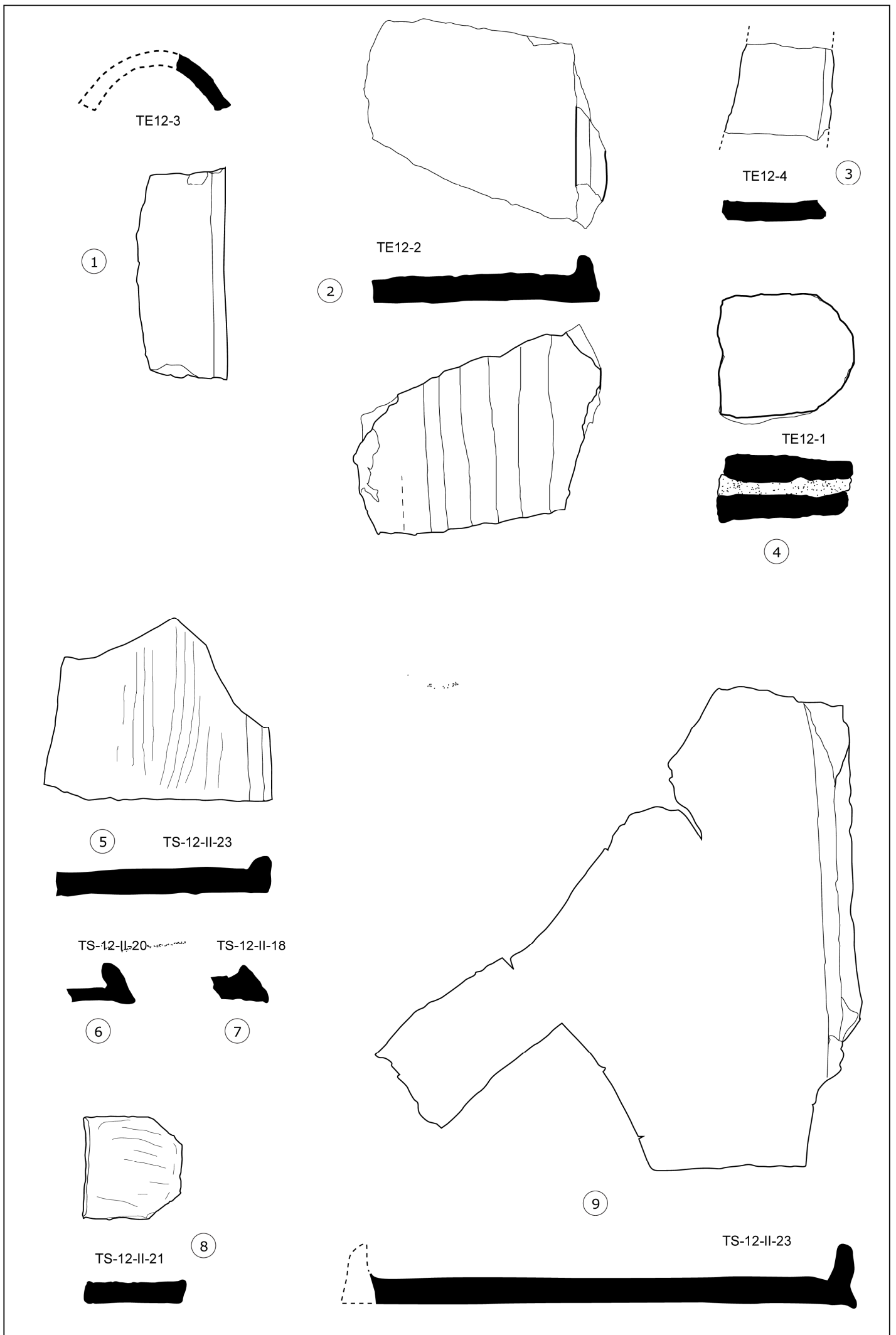

Tav.14 Synthronon e Tomba "e". Tegole e laterizi

0 10 20 cm

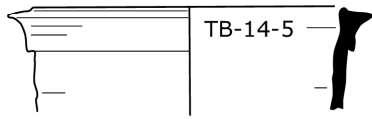

①

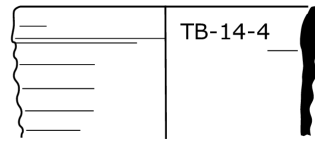

②

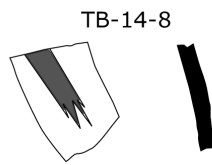

③

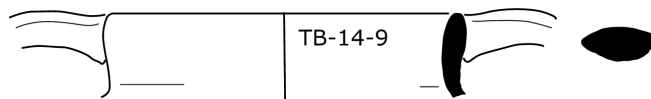

④



⑤

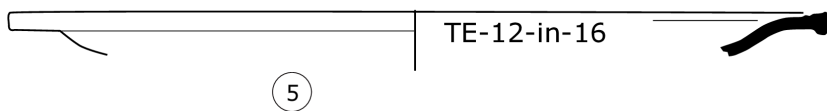
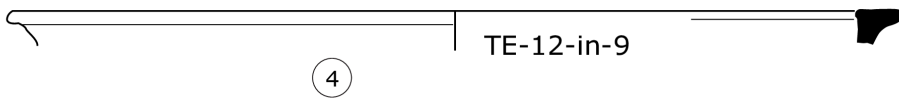
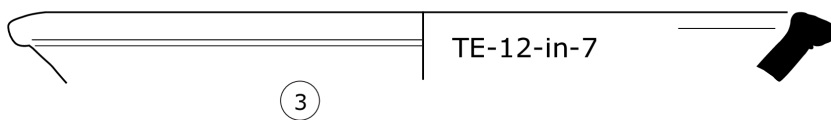
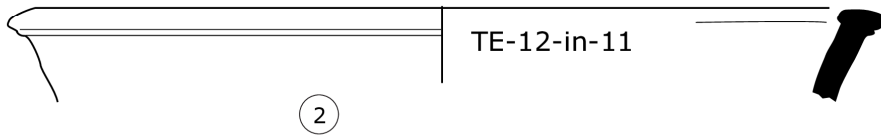
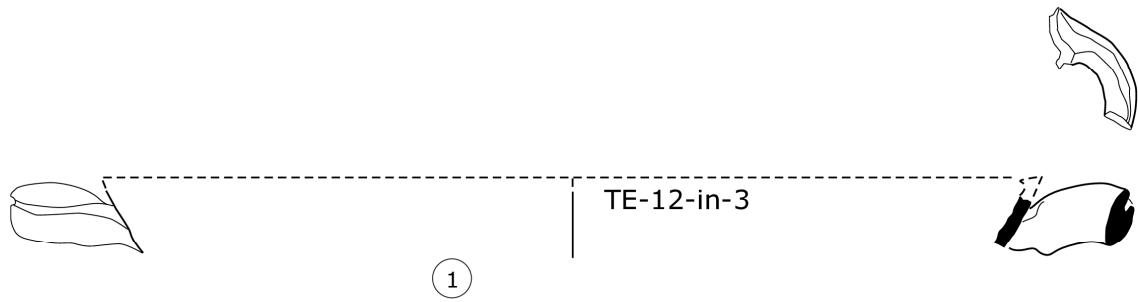

TE-12-in-1



⑦



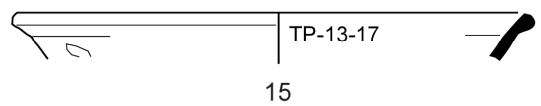
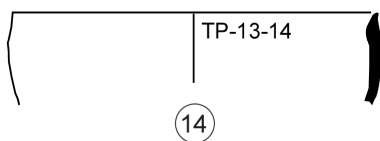
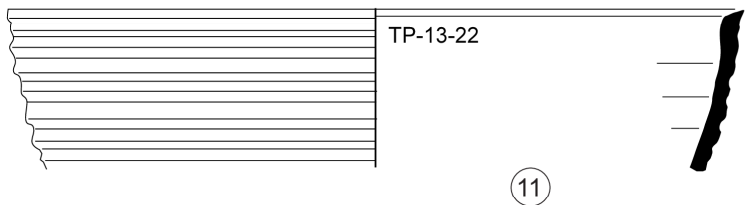
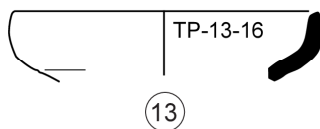
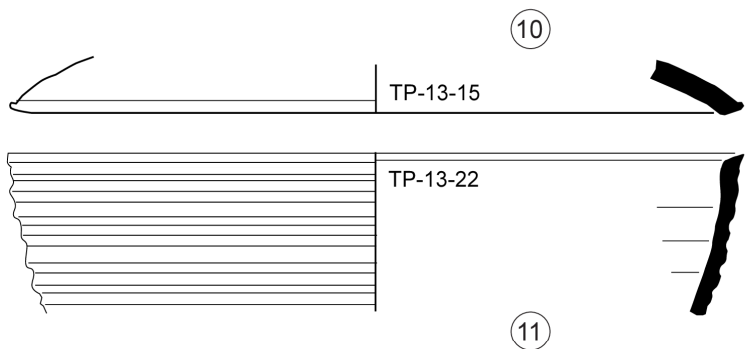
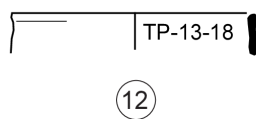
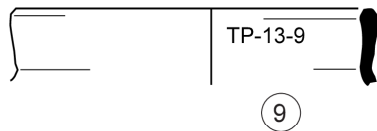
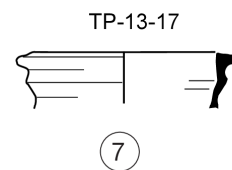
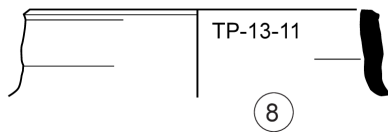
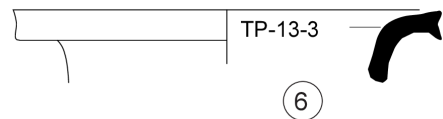
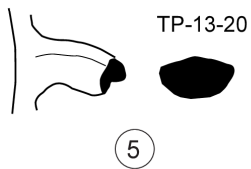
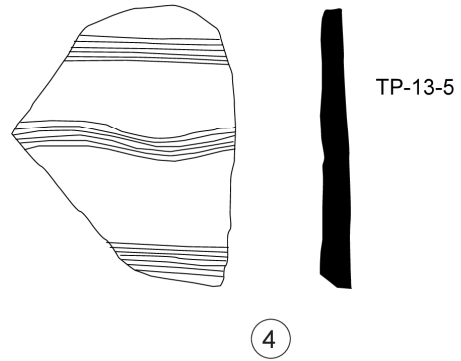
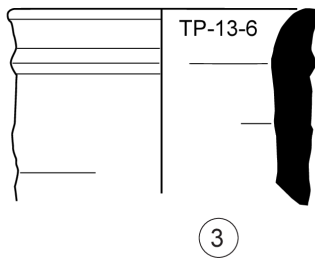
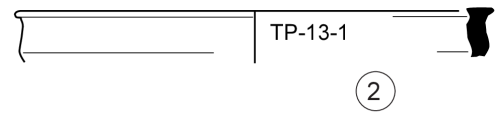
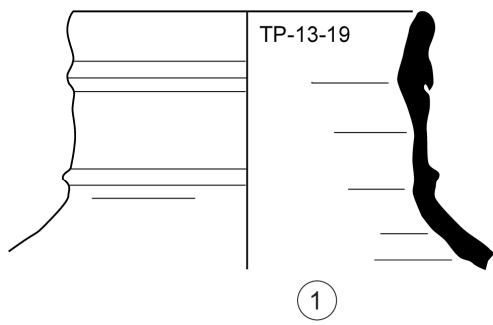

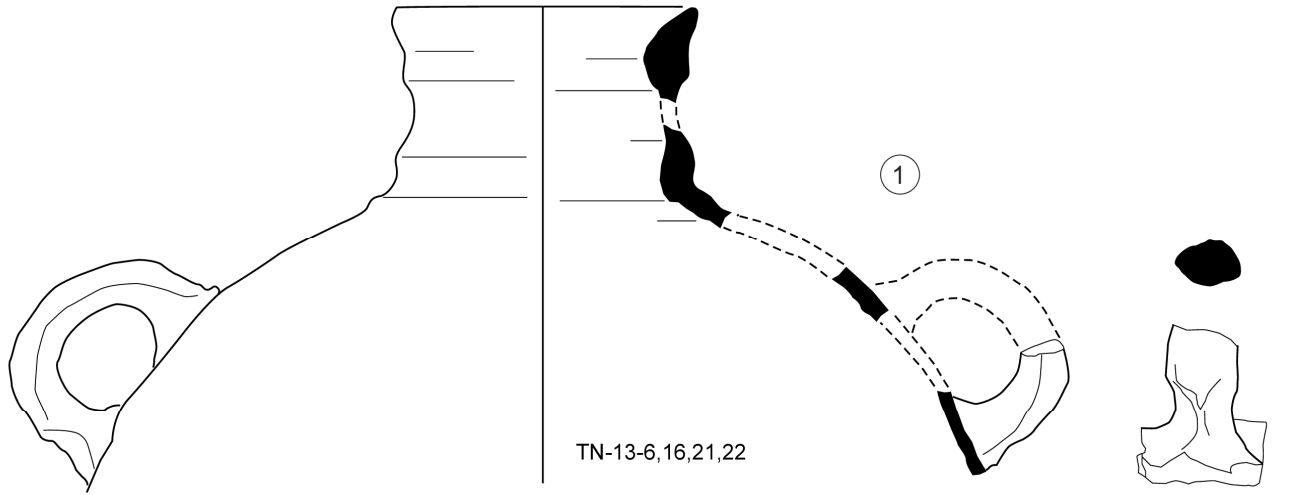

2



3

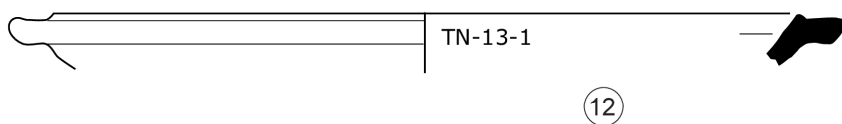
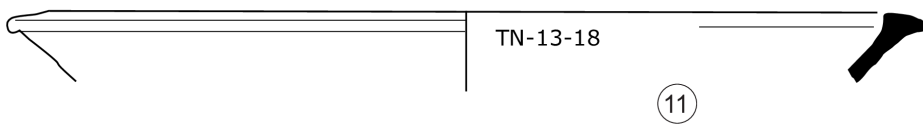
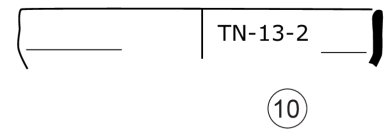
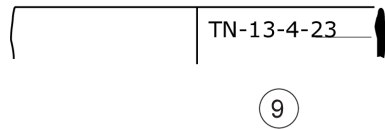
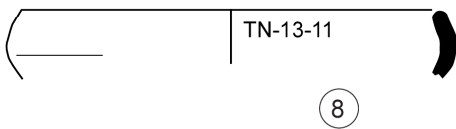
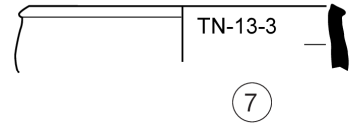
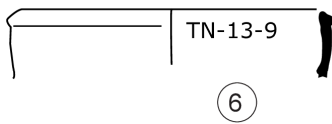
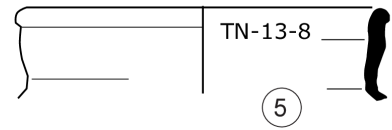
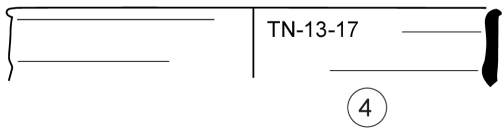
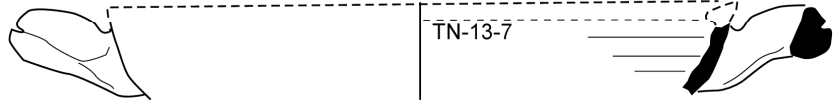
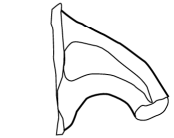

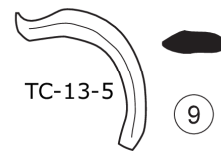
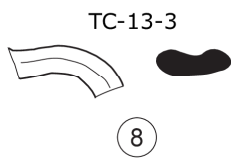
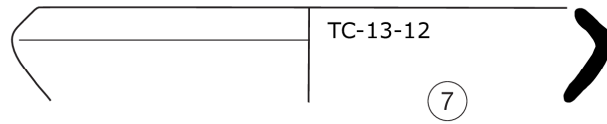
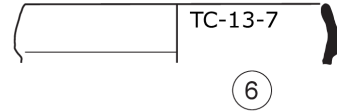
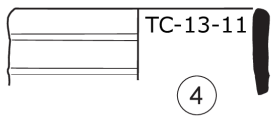
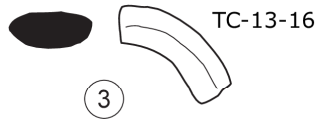
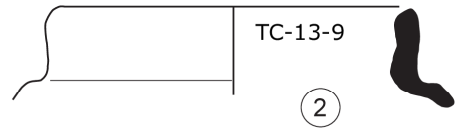
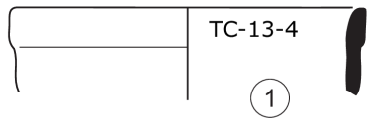

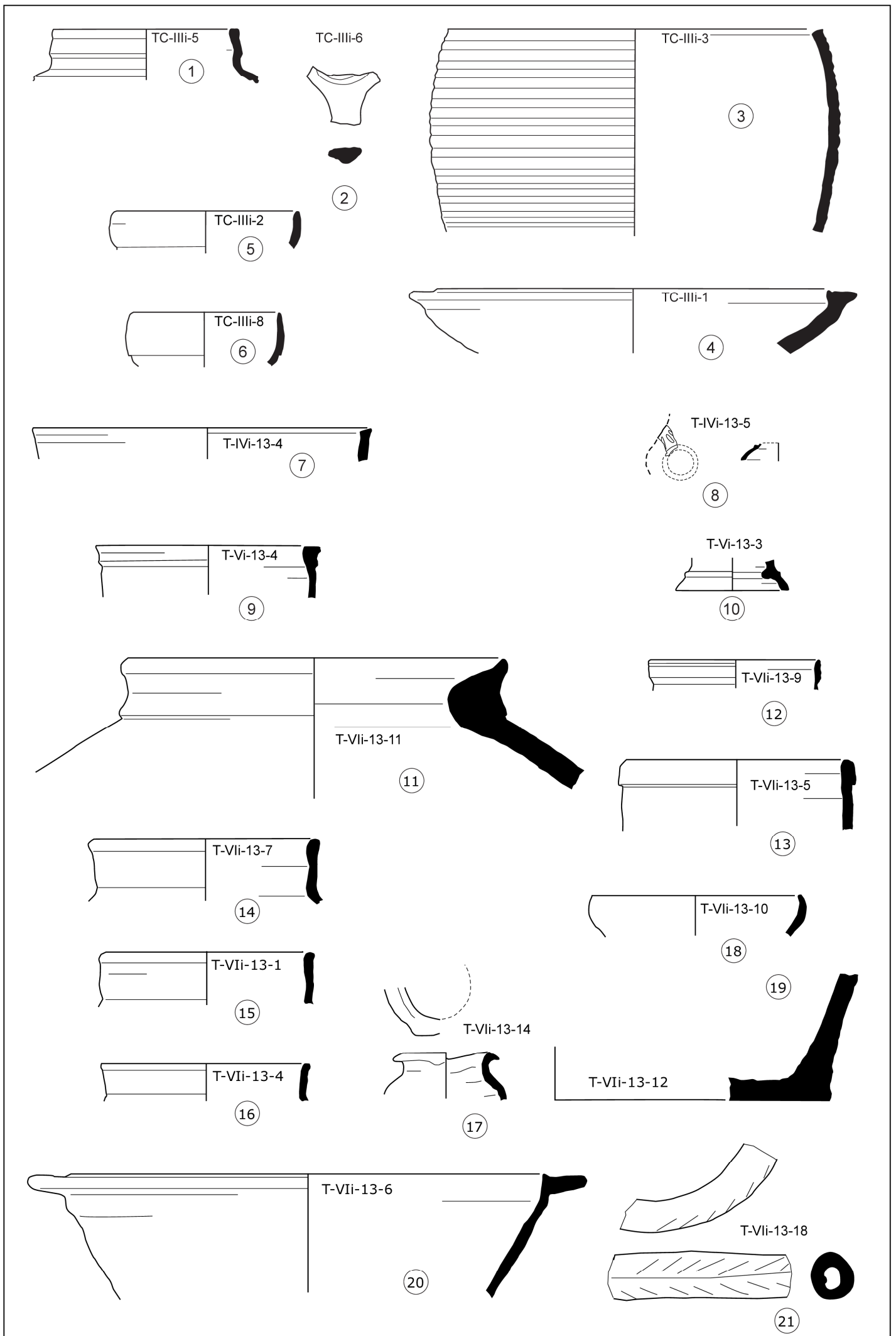

Tav.20 Intercolumni nord. Reperti da varie UUSS.



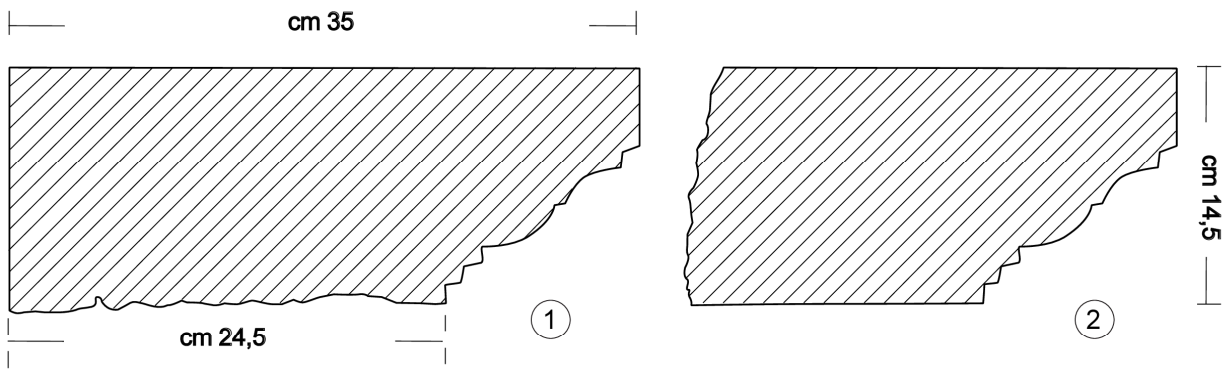

TC-13-17

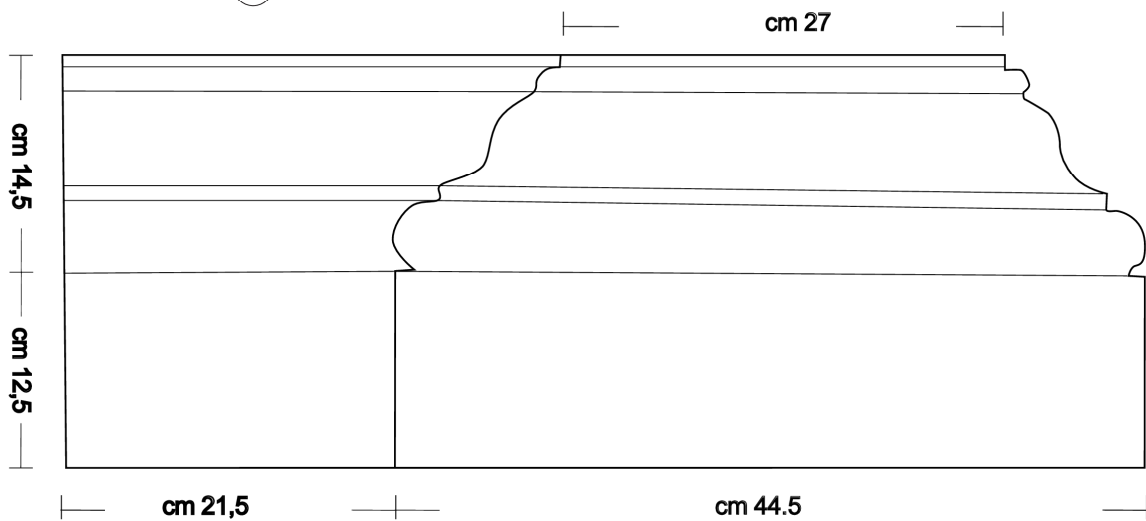
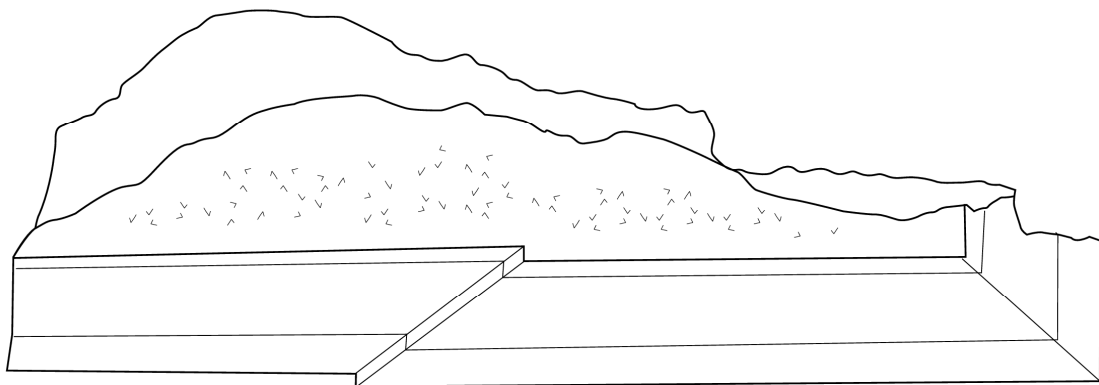
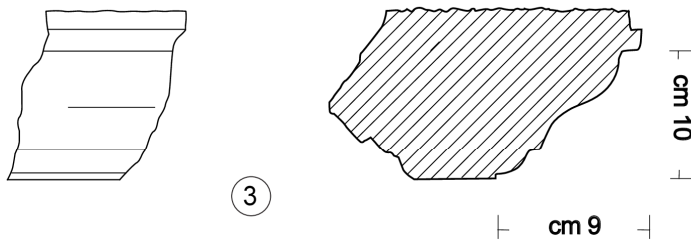

Tav.21 Marmi alabastrini di varia provenienza

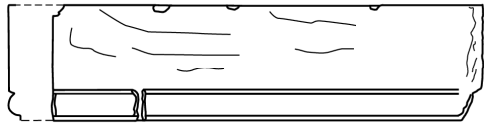

1

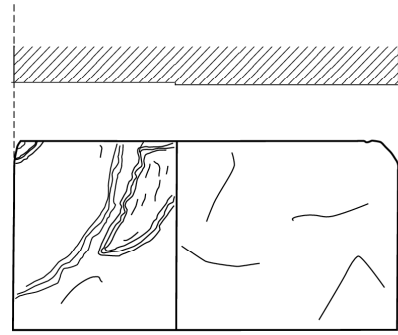

2

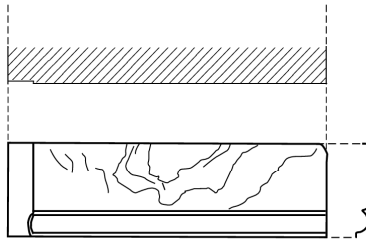

3



4



5

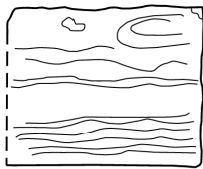

6

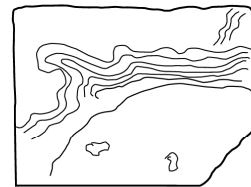

7

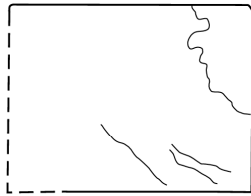

8

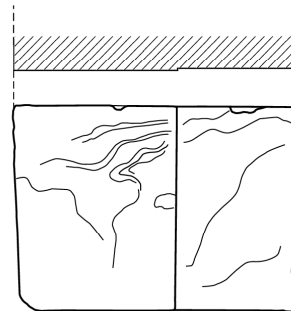

9

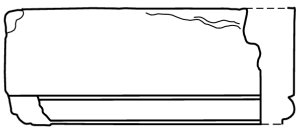

10

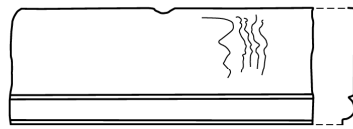

11

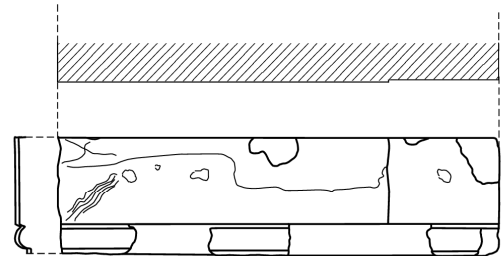

12

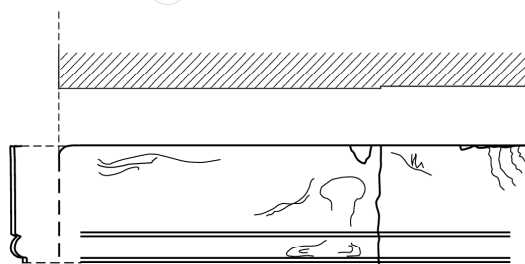

13

Tav.22 Marmi alabastrini dalla tomba centrale

0 10 20 30 cm

MN103-A-16

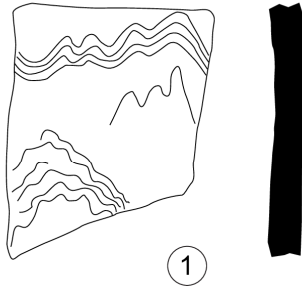

MN103-A-12

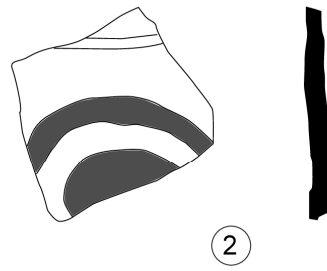

MN103-A-3

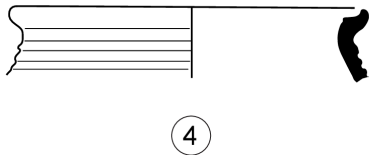

MN103-A-14

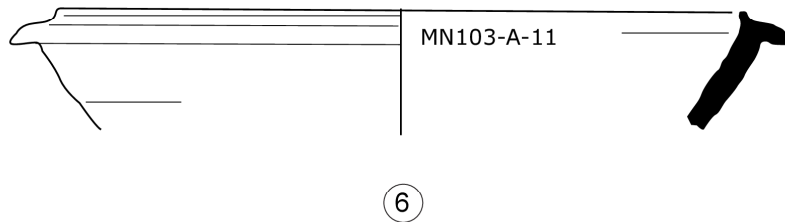
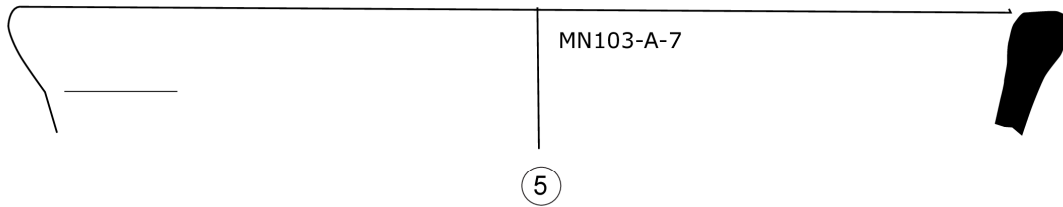
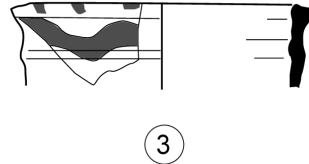

MN103-A-10

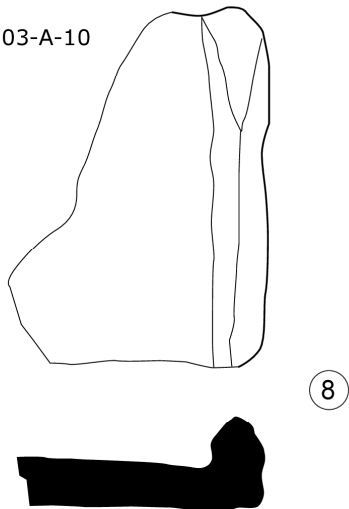

MN103-A-9

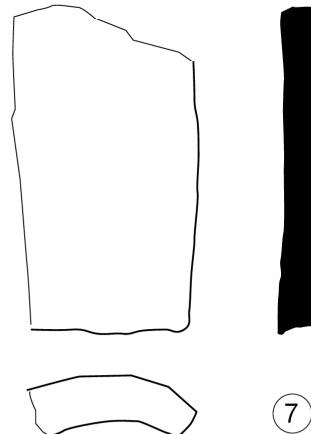

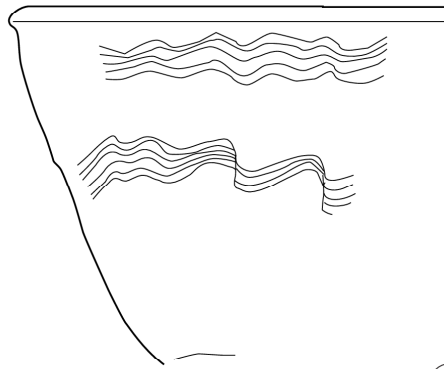

MN103-B-1

①

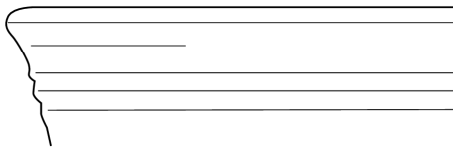
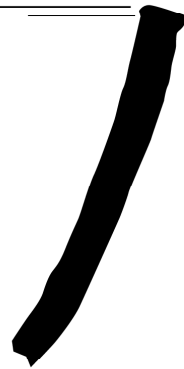

MN103-B-2

②

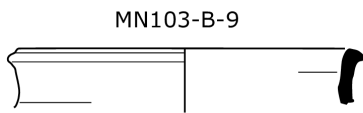

MN103-B-9

③

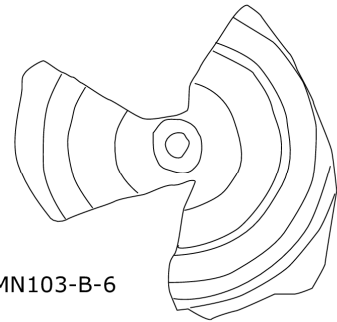

MN103-B-6

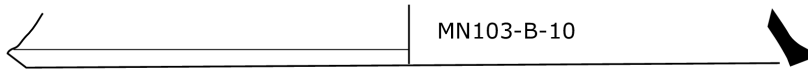

MN103-B-10

④



⑤

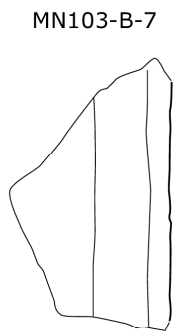

MN103-B-7

⑦

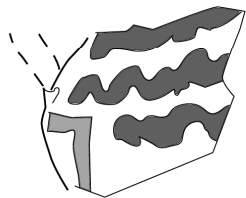

MN103-B-14

⑥

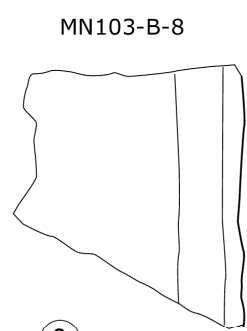

MN103-B-8

⑧



Mn-103-3

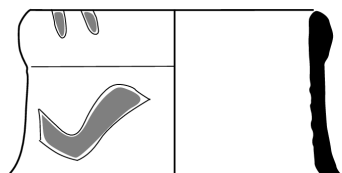

①

Mn-103-18

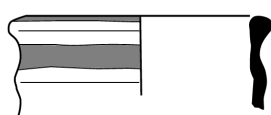

②

Mn-103-30

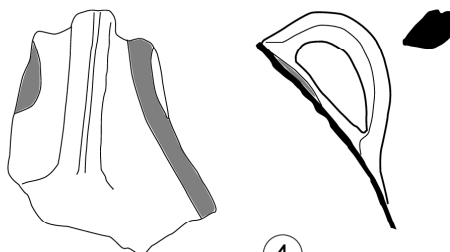

④

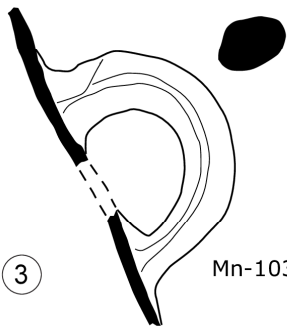

③

Mn-103-61

Mn-103-40

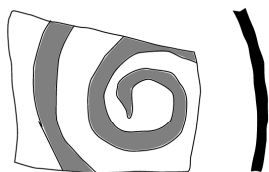

⑤

Mn-103-43

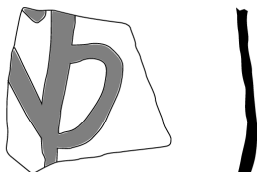

⑥

Mn-103-42

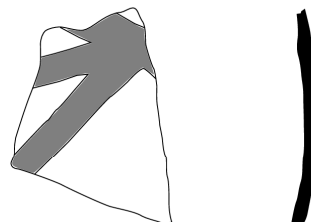

⑦

Mn-103-63

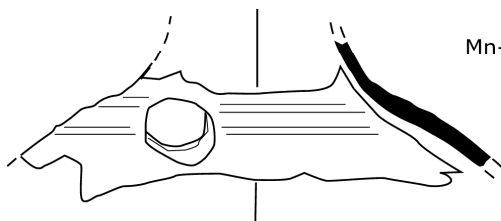

⑧

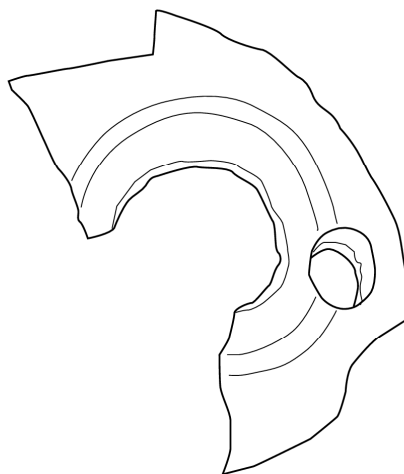

Mn-103-62

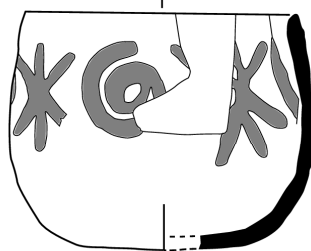

⑨

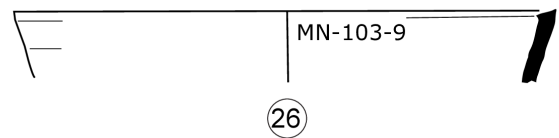
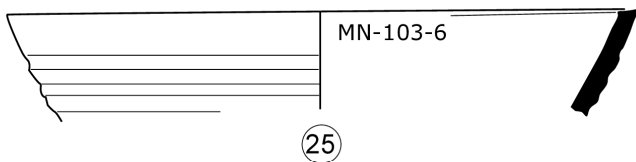
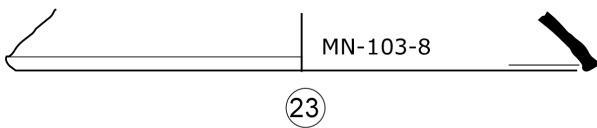
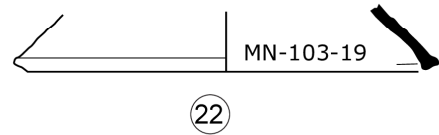
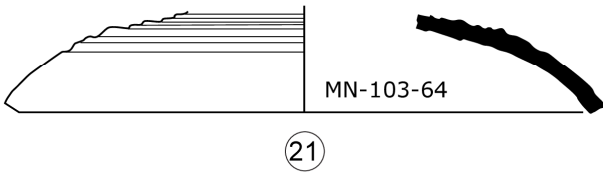
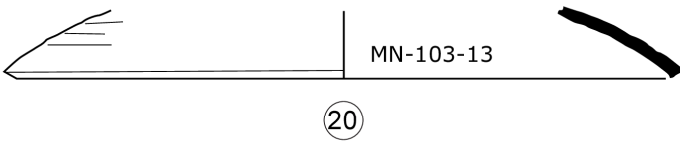
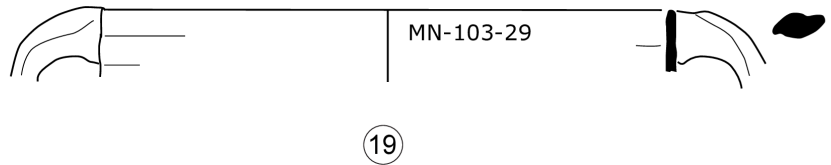
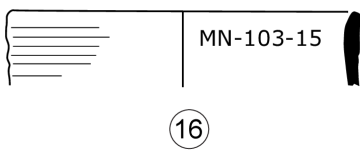
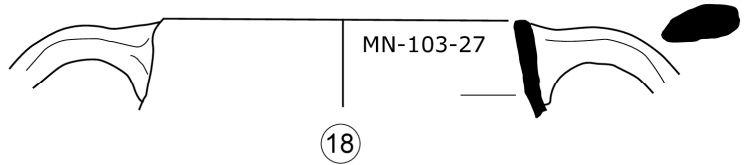
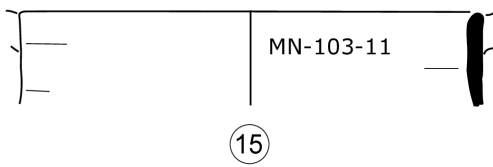
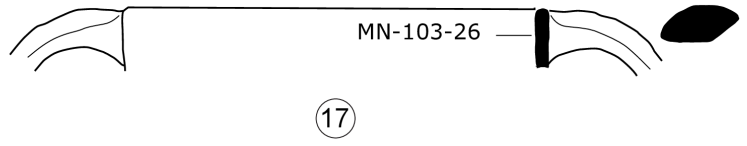
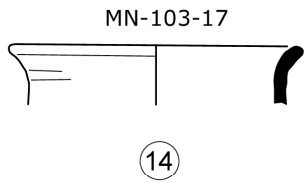
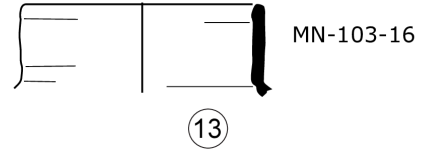
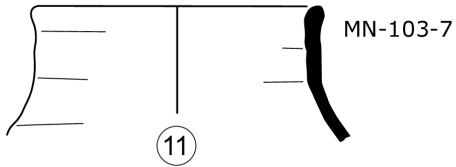
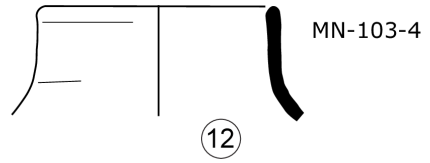
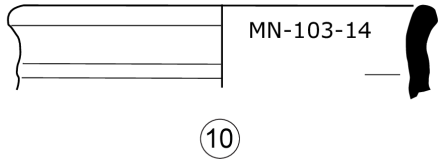

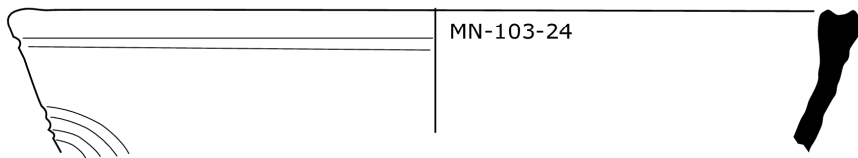

MN-103-24

27

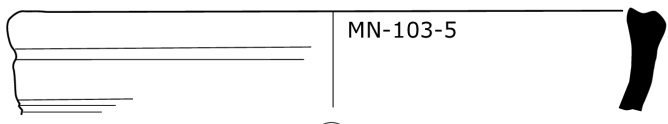

MN-103-5

28

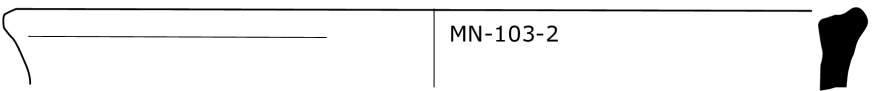

MN-103-2

29

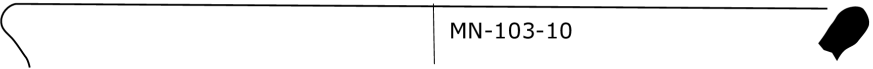

MN-103-10

30

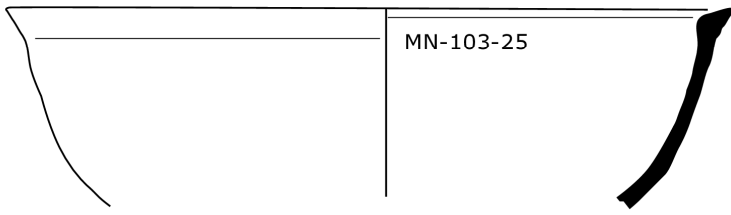

MN-103-25

31

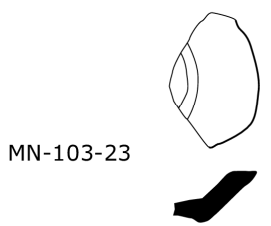

MN-103-23

32

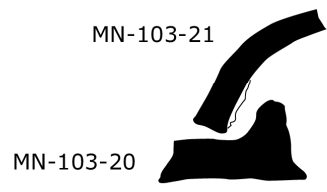

MN-103-21

MN-103-20

33

34

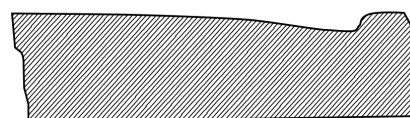
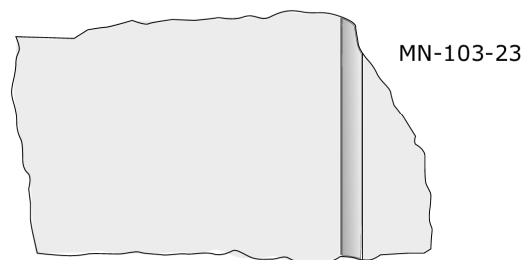
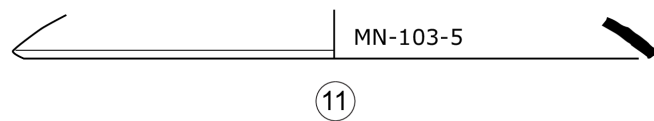
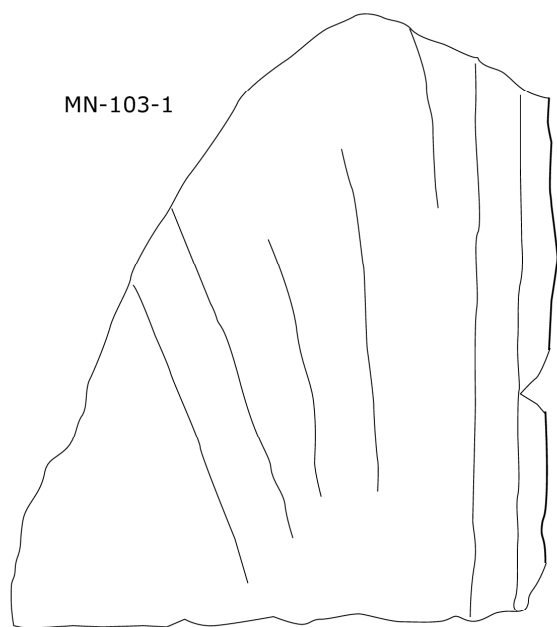
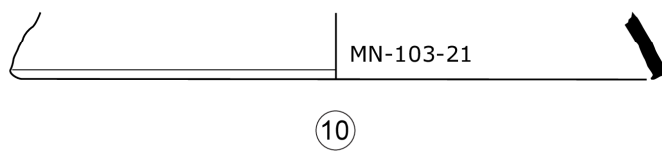
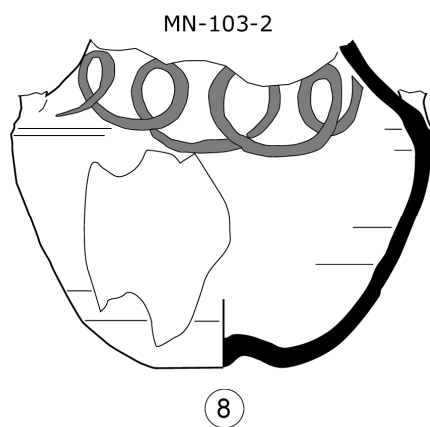
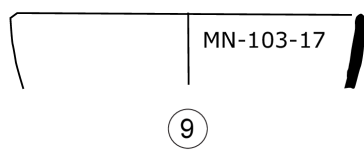
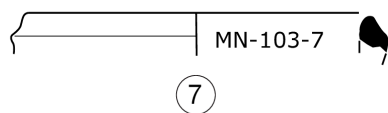
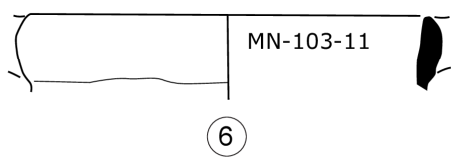
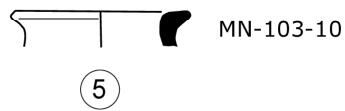
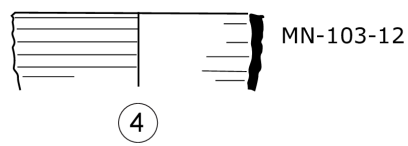
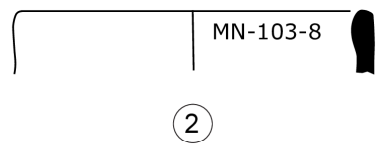
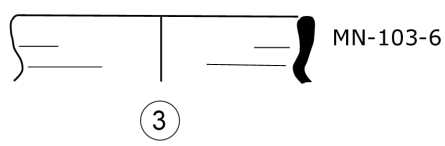
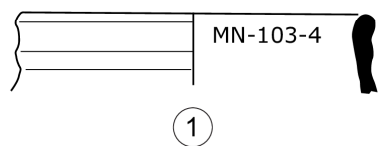



S\_21160

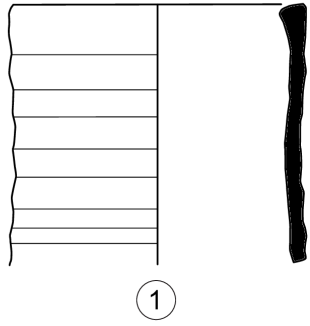

S\_21161

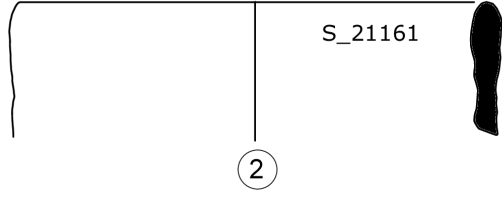

S\_21156

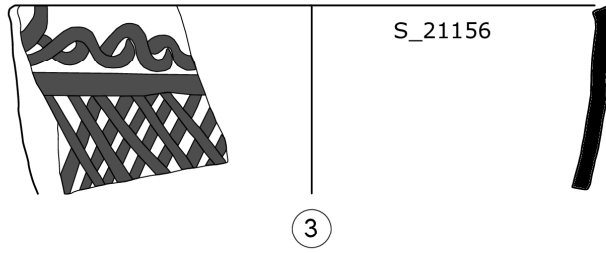

S\_21152

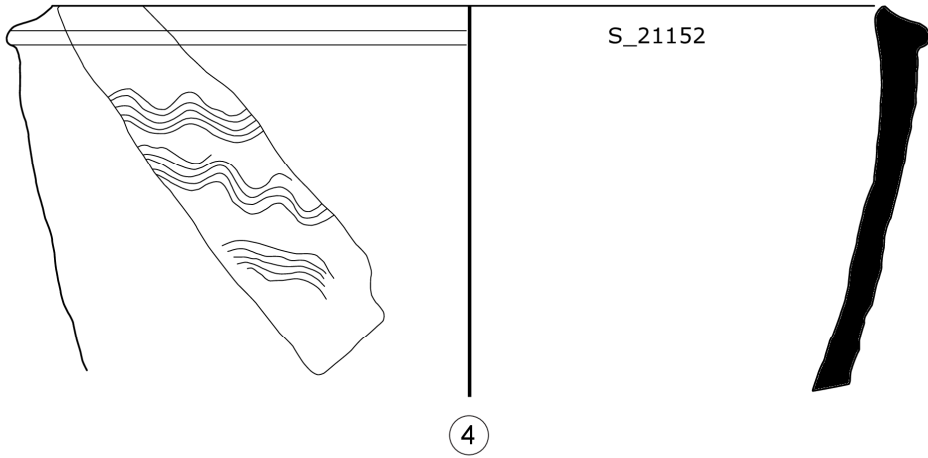

S\_21167

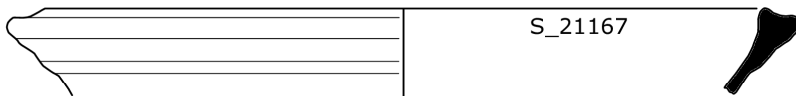

S\_21159

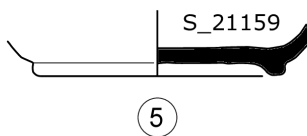

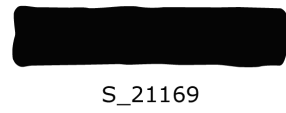
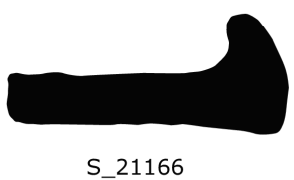
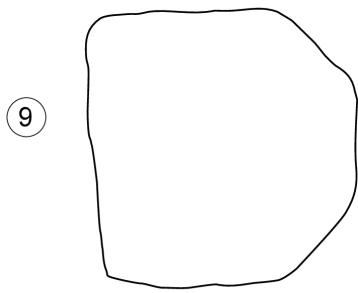
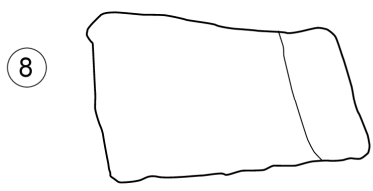
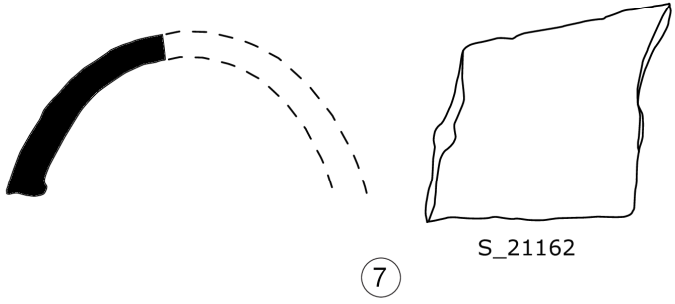
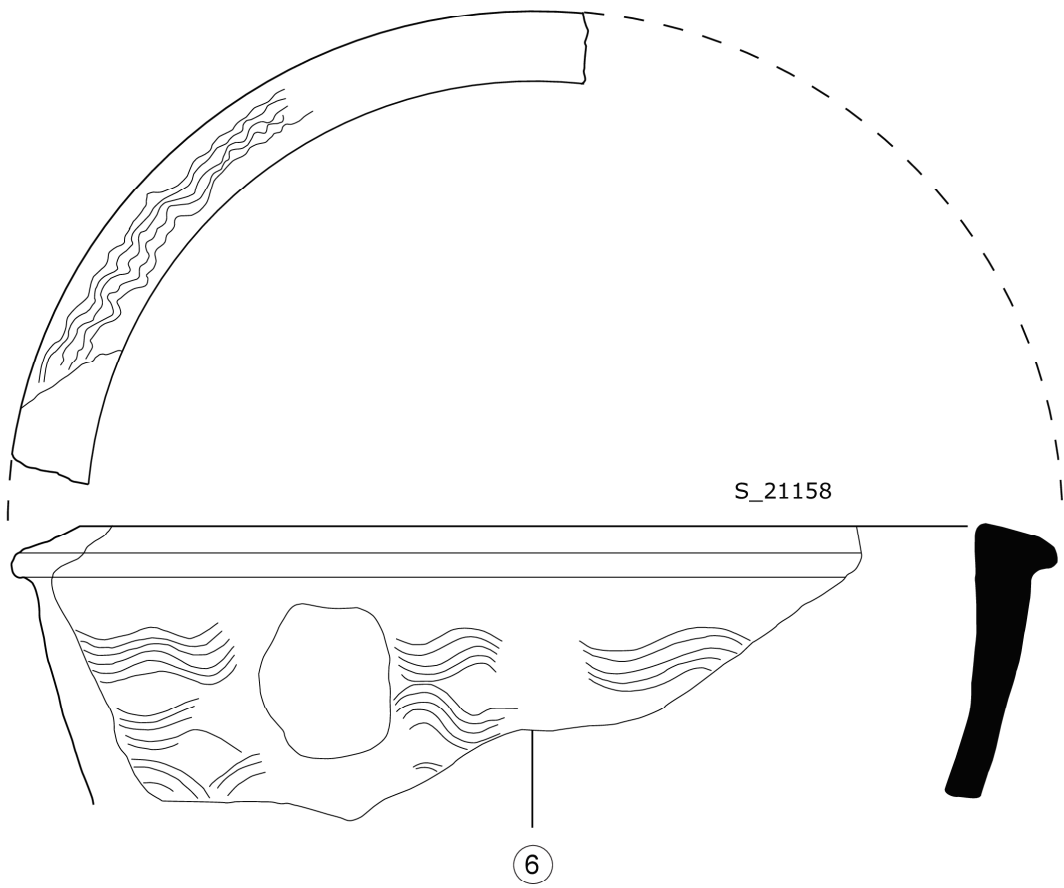

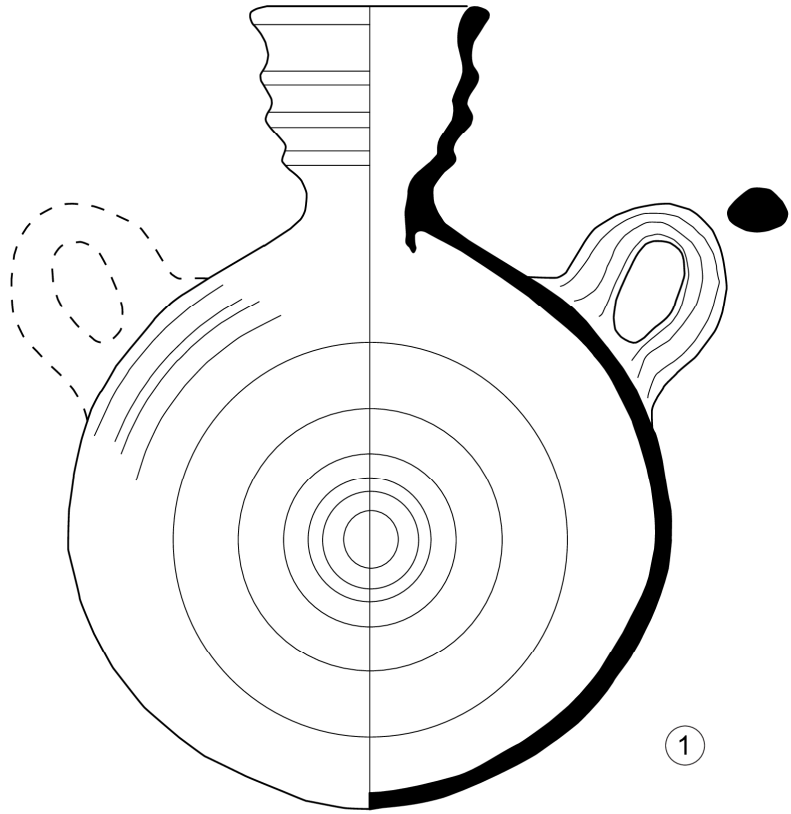

S\_21200\_21240\_21292

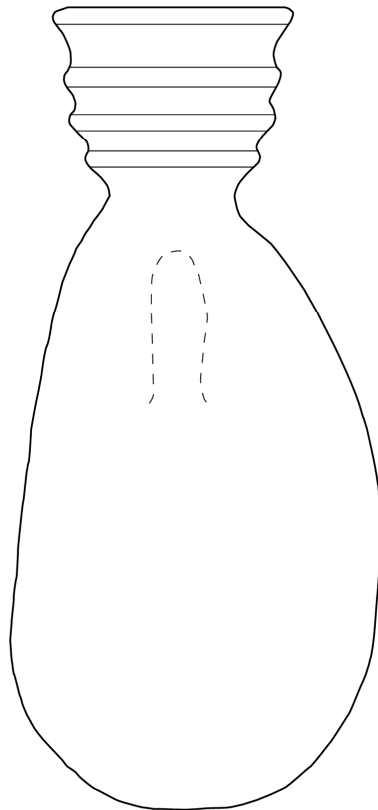

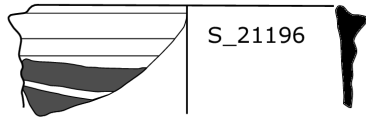

2

S\_21205\_21229\_21253\_21254

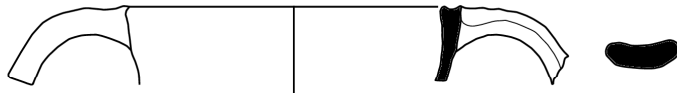

3

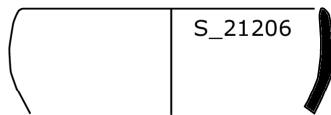

4

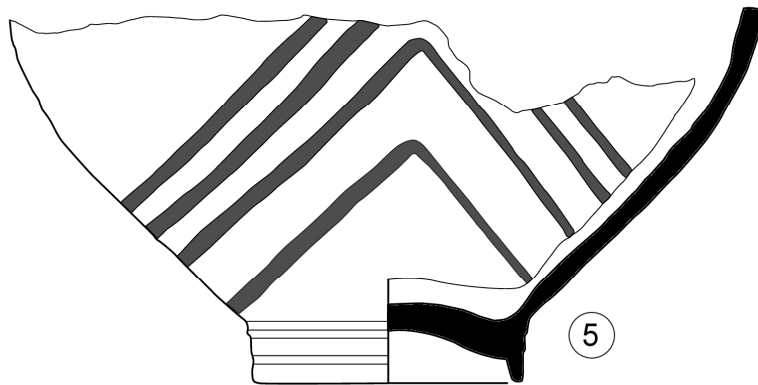

5

S\_21204

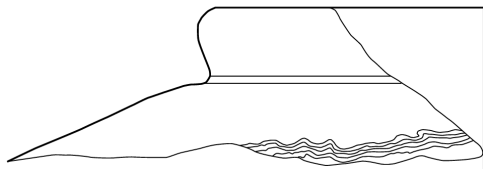

S\_21210

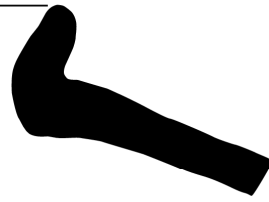

①

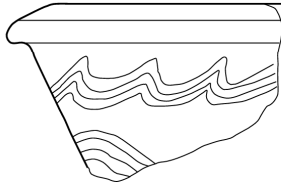

S\_21214



②

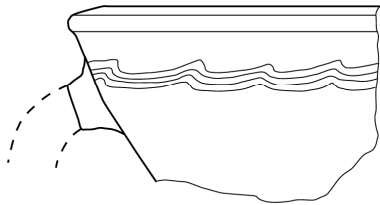

S\_21215



③

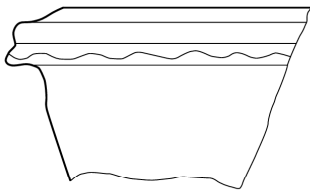

S\_21216



④

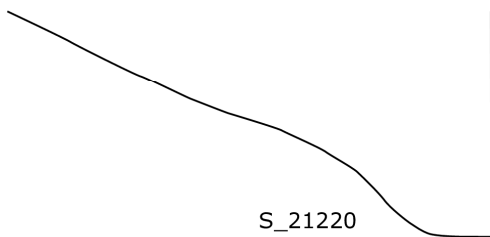

S\_21220

⑤

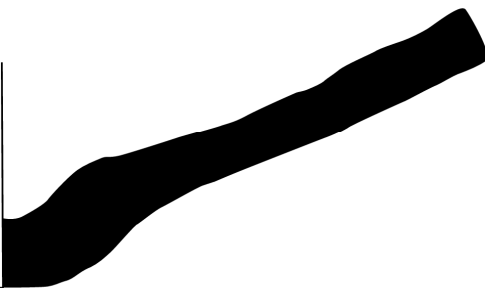

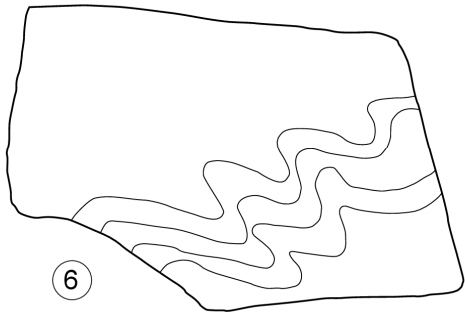

6

S\_21211

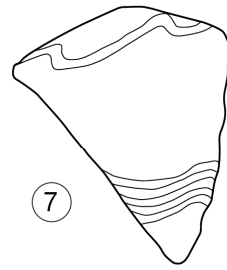

7

S\_21217

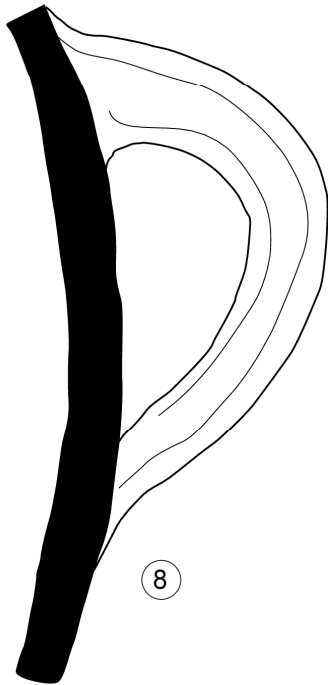

8

S\_21212

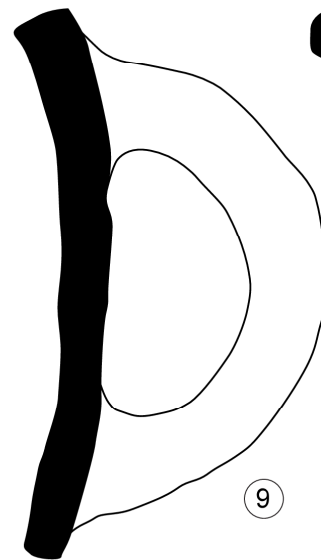

9

S\_21223

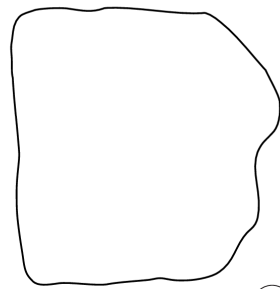

10



S\_21219

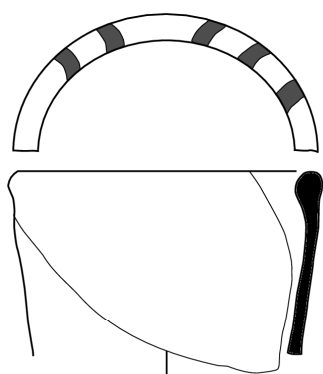
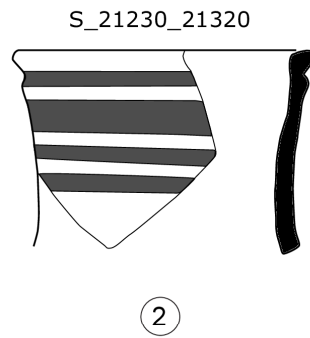
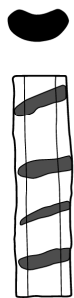
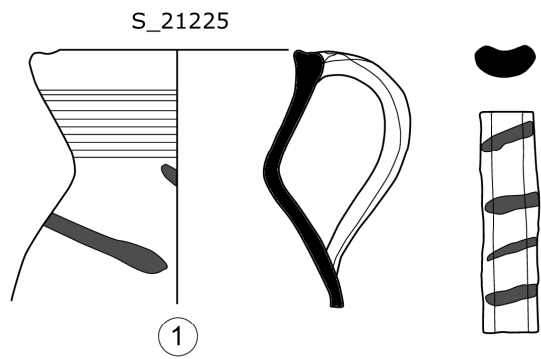

S\_21231\_21291\_21317\_21348

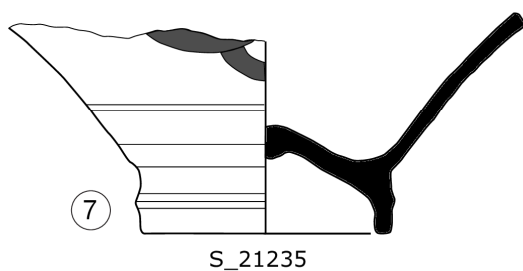
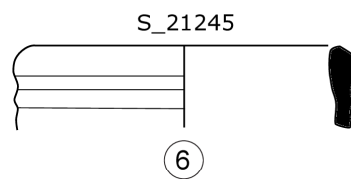
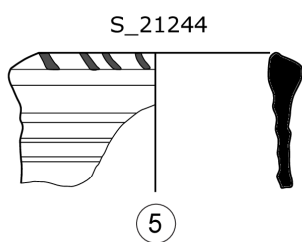
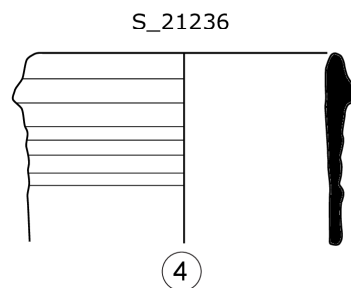

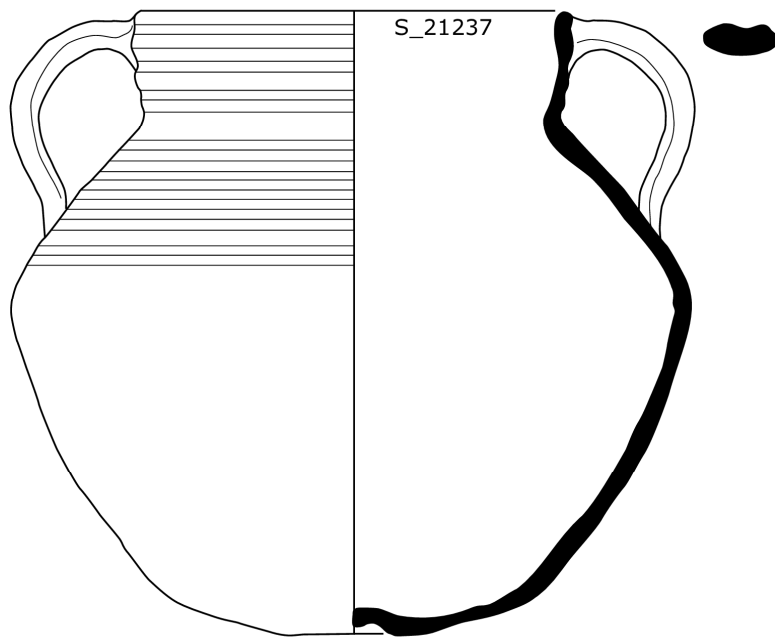

S\_21237

8

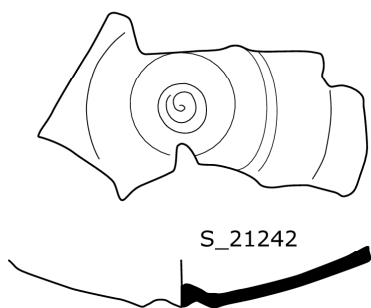

S\_21242

9

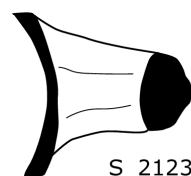

S\_21239

10

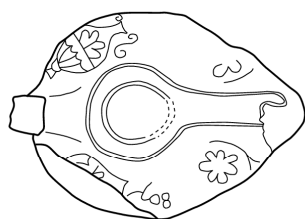

10

S\_21226

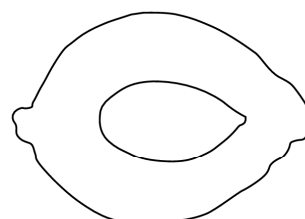
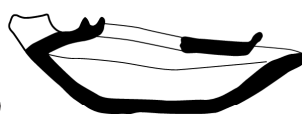



S\_21259

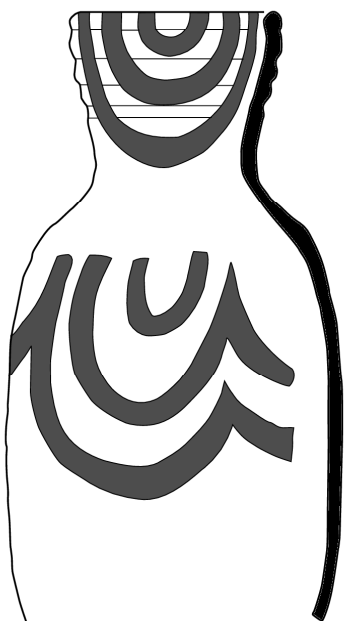

①

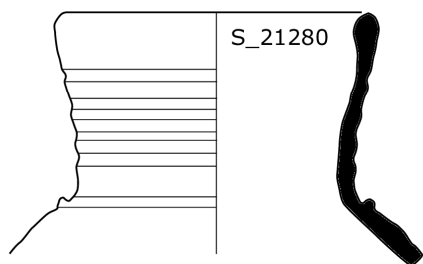

S\_21280

②

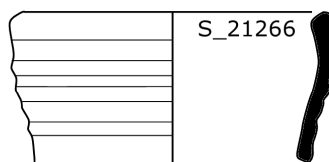

S\_21266

③

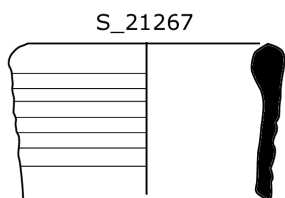

S\_21267

④

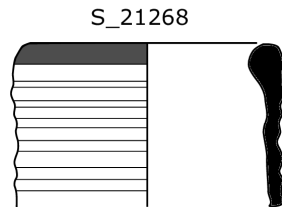

S\_21268

⑤

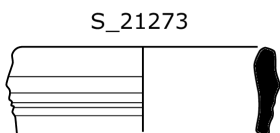

S\_21273

⑥

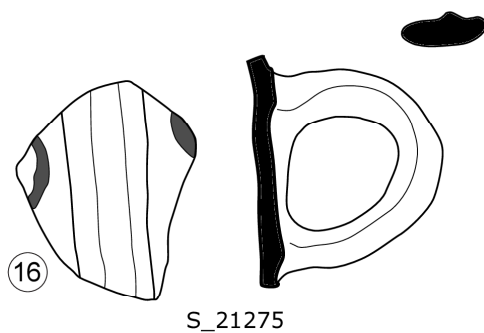
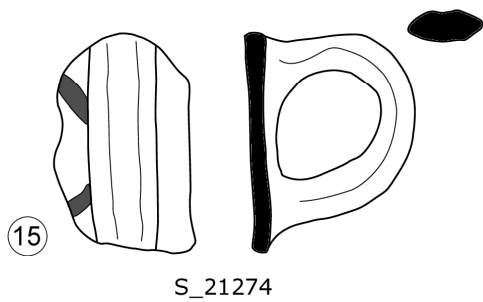
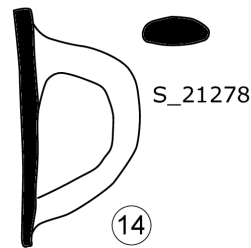
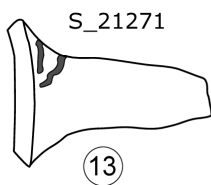
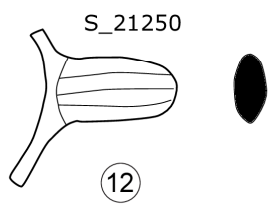
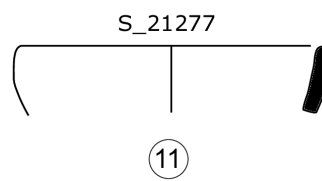
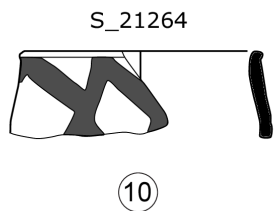
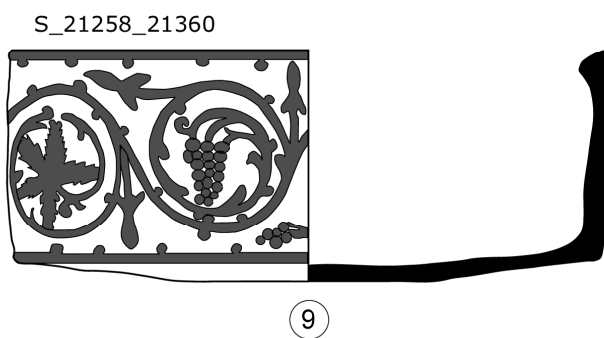
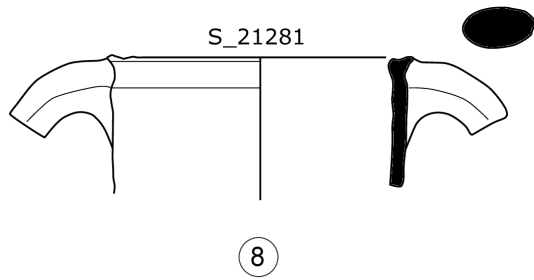
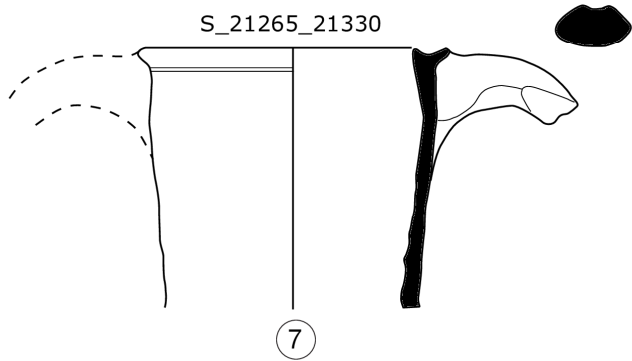

S\_21290\_21316\_21345

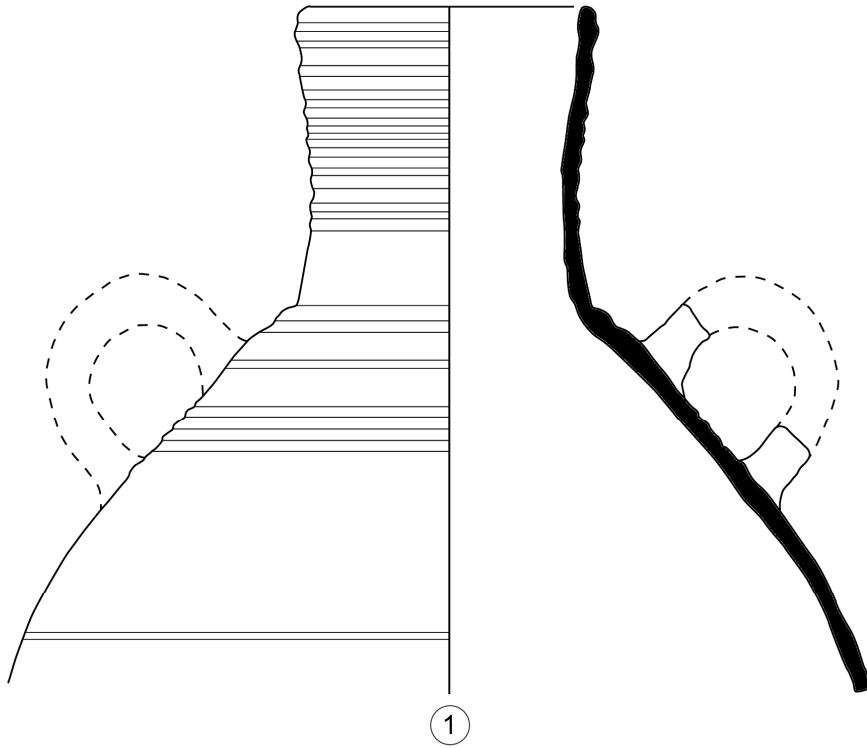

US\_21287\_21362\_21315\_21325

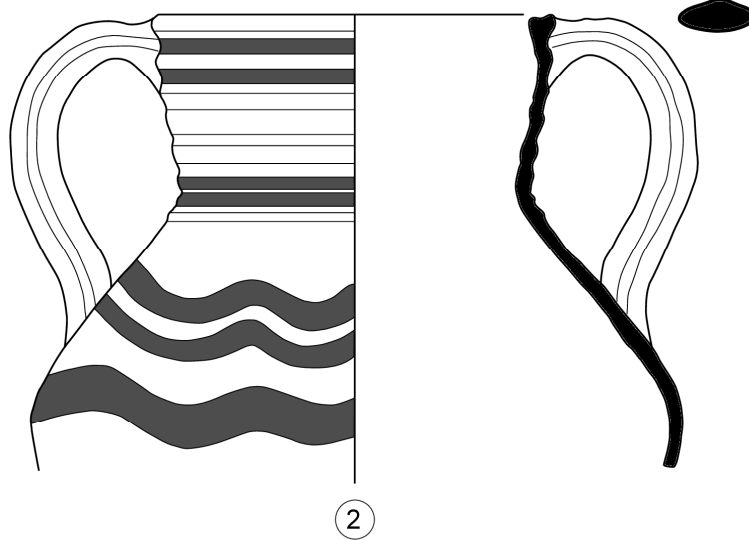

S\_21262\_21294

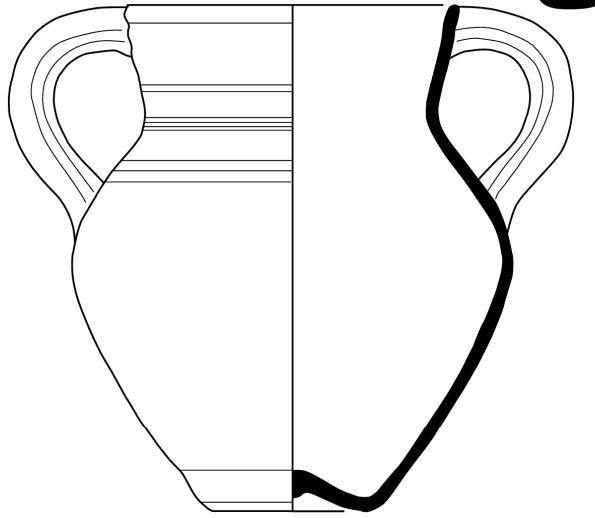

3

S\_21302

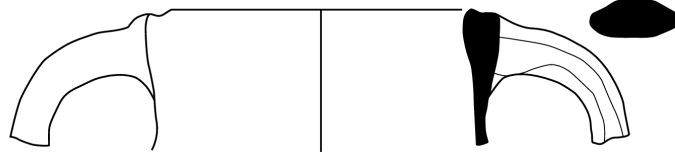

4

S\_21301\_21224

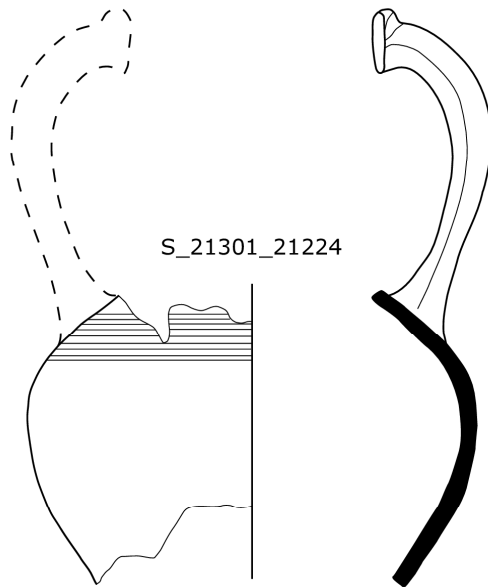

5

S\_21288

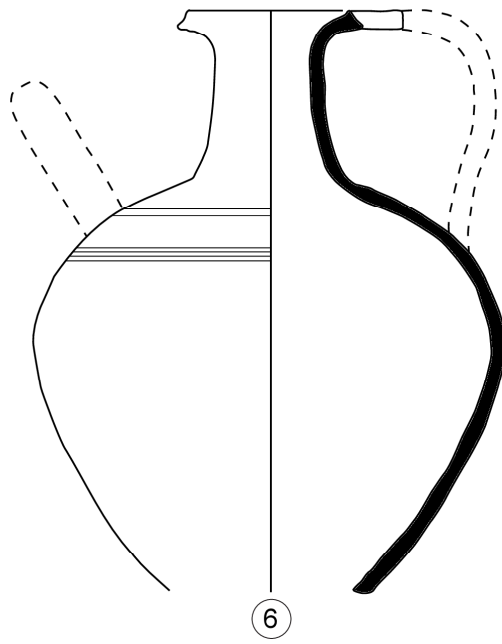

S\_21303

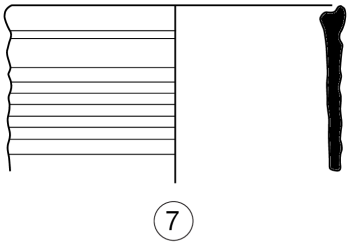

S\_21312

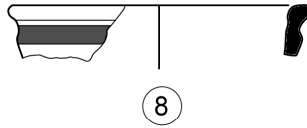

S\_21311

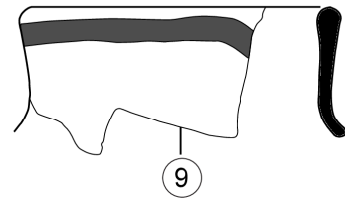

S\_21306

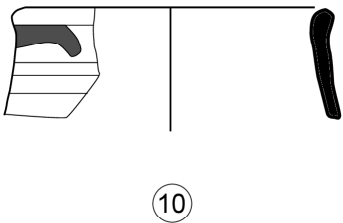

S\_21295

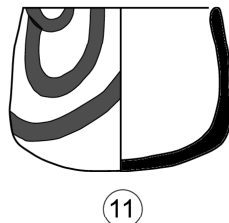

S\_21310

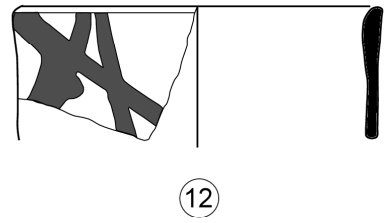

S\_21295/1

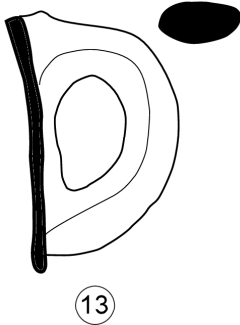

S\_21300

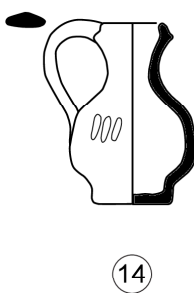

S\_21309



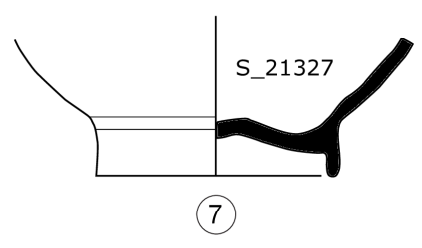
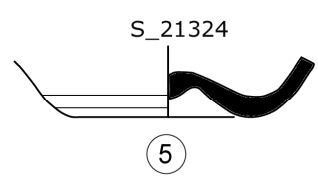
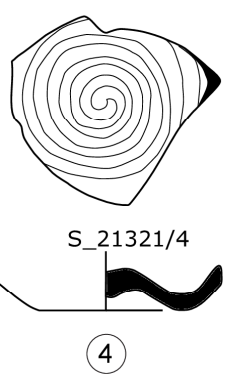
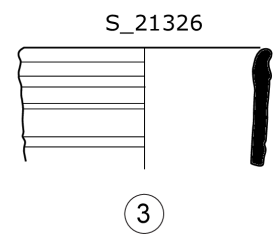
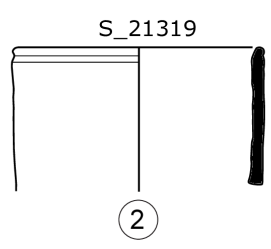
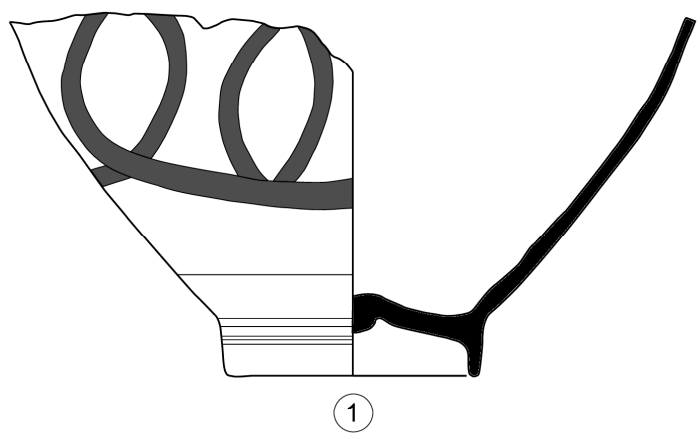
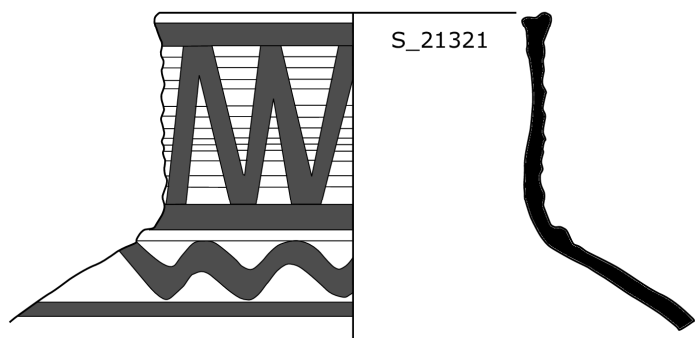

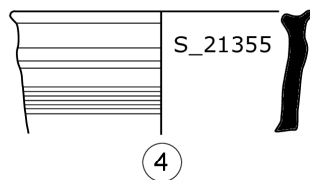
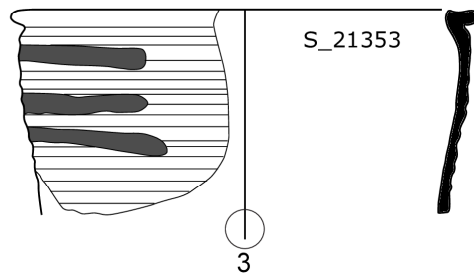
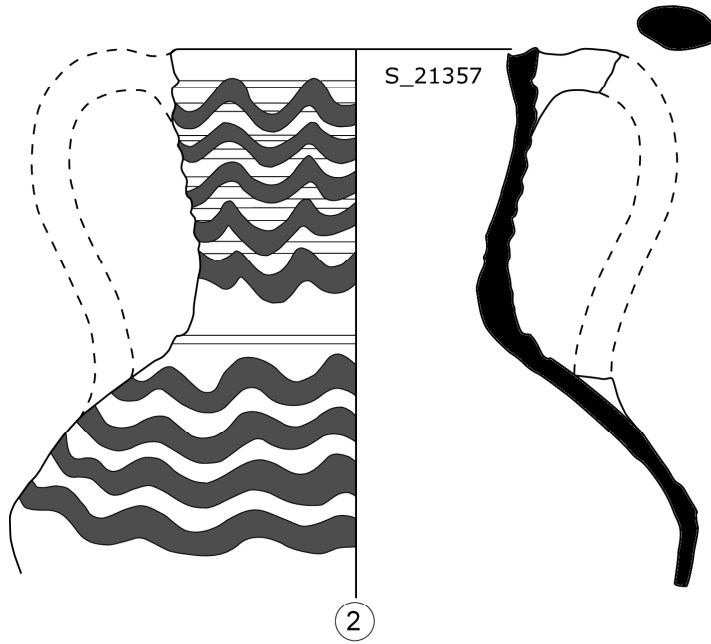
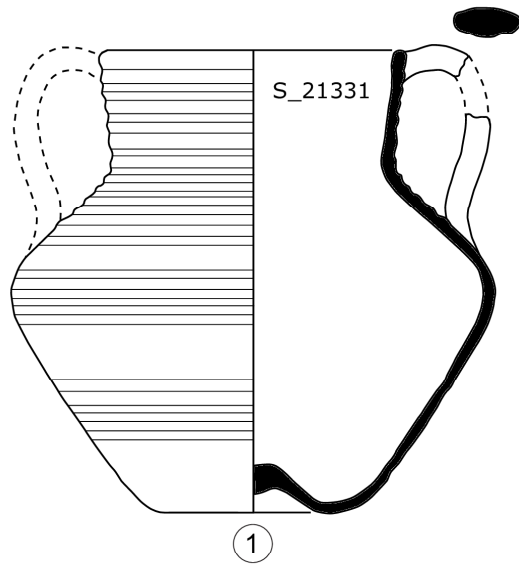

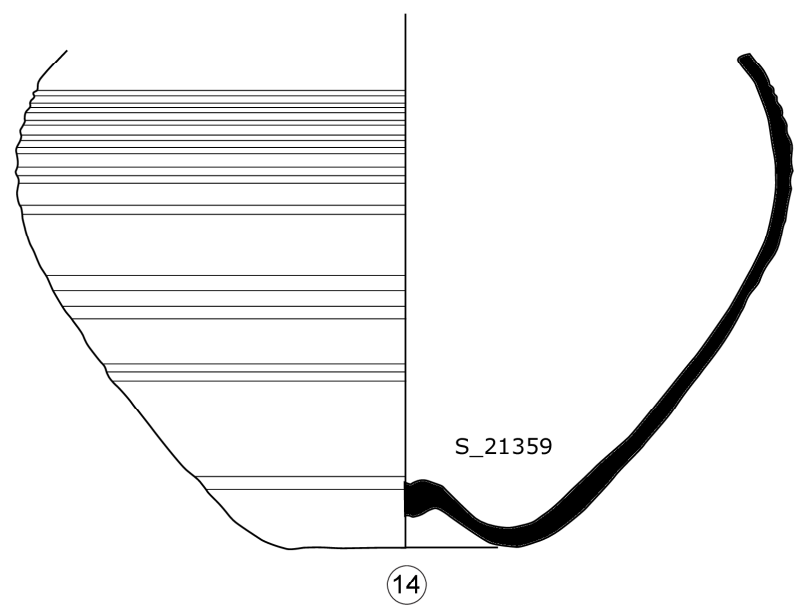
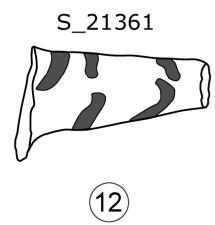
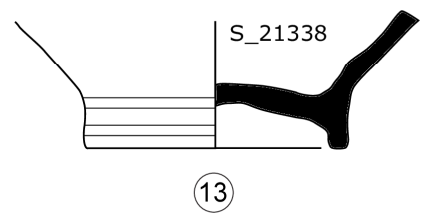
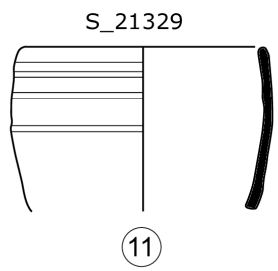
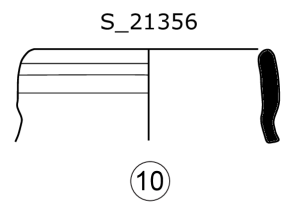
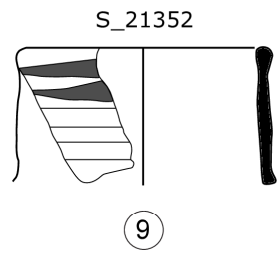
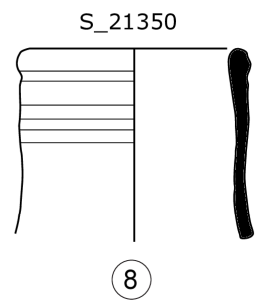
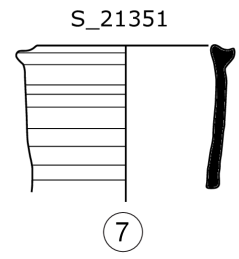
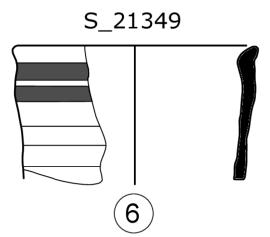
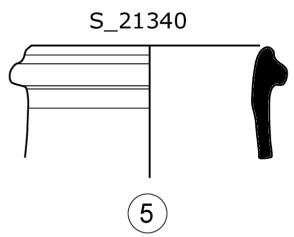



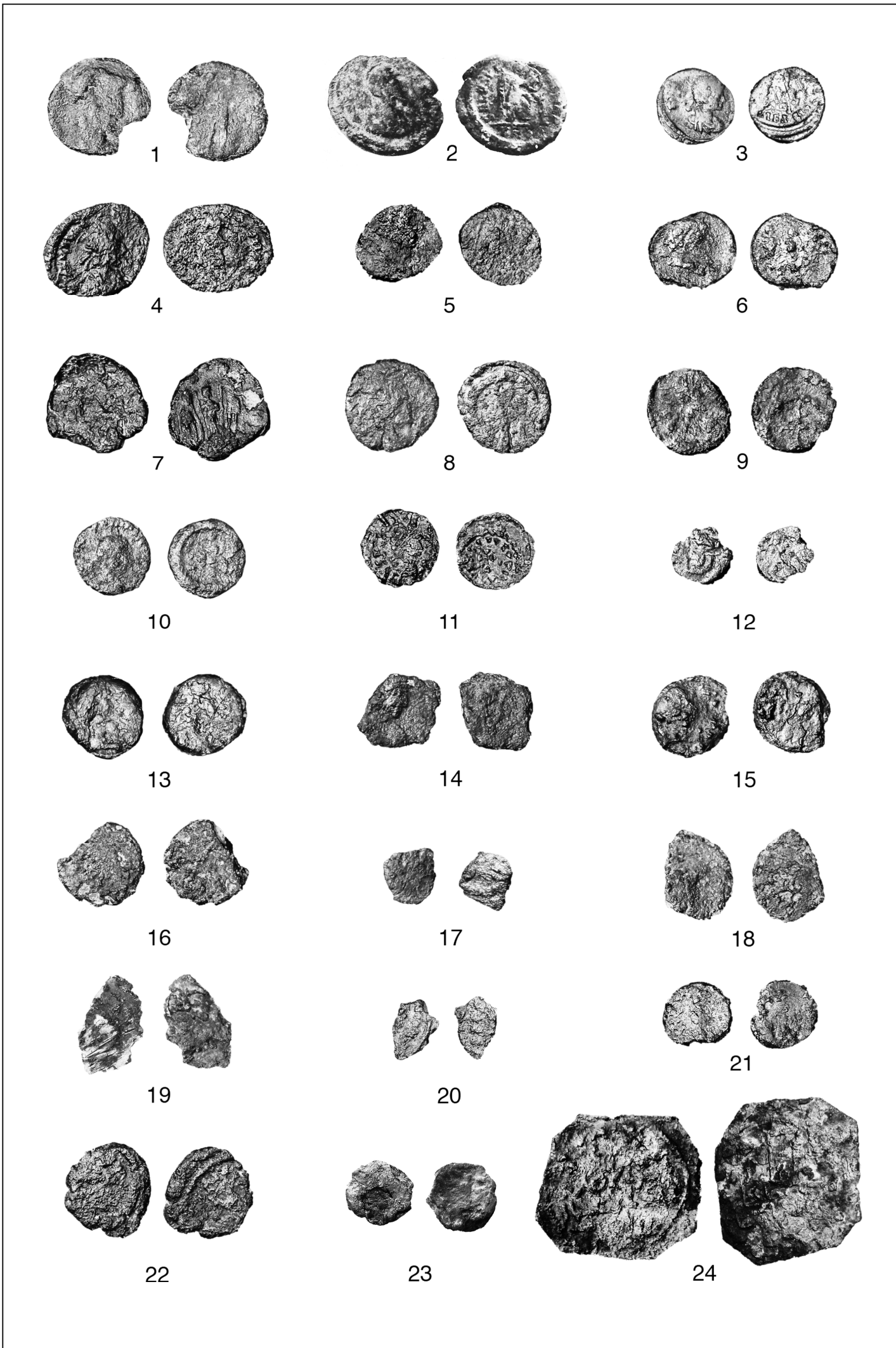

Tav.45 Monete recuperate nello scavo della basilica