



UNIVERSITÀ DEGLI STUDI DI MILANO
FACOLTÀ DI SCIENZE MATEMATICHE FISICHE E NATURALI
DOTTORATO DI RICERCA IN
FISICA, ASTROFISICA E FISICA APPLICATA

NON-MARKOVIANITY AND INITIAL CORRELATIONS IN THE DYNAMICS OF OPEN QUANTUM SYSTEMS

Settore Scientifico disciplinare FIS/02

Tutore: Dott. Bassano VACCHINI

Coordinatore: Prof. Marco BERSANELLI

Tesi di Dottorato di:
Andrea SMIRNE
Ciclo XXIV

Anno Accademico 2010-2011

Abstract

In the present thesis we investigate two basic issues in the dynamics of open quantum systems, namely, the concept of non-Markovianity and the effects of initial system-environment correlations in the subsequent reduced dynamics.

In recent research, a great effort has been put into the study and understanding of non-Markovian features within the dynamics of open quantum systems. At the same time, quantum non-Markovianity has been defined and quantified in terms of quantum dynamical maps, using either a divisibility property or the behavior of the trace distance between pairs of reduced states evolved from different initial states. We investigate these approaches by means of several examples, focusing in particular on their relation with the very definition of non-Markov process used in classical probability theory. Indeed, the notion of non-Markovian behavior in the dynamics of the state of a physical system and the notion of non-Markov process are quite different and it will appear how the former represents sufficient, but not necessary condition with respect to the latter. In particular, we explicitly show that the above-mentioned divisibility property in the classical case is not, in general, equivalent to the Chapman-Kolmogorov equation, proper to Markov stochastic processes. Furthermore, by taking into account a bipartite open system, we emphasize how the presence of non-Markovian effects strongly depends on where the border between open system and environment is set.

A second relevant topic investigated in this thesis concerns the dynamics of open quantum system in the presence of initial system-environment correlations. By means of the approach based on trace distance, we go beyond the usual assumption that the open system and the environment are initially uncorrelated. The trace-distance analysis provides a characterization of open-system dynamics relying on measurements on the open system only, without the need for any extra information about the total system or system-environment interaction. After an introduction to the general theoretical scheme, we report an all-optical experimental realization, in which the total system under investigation consists of a couple of entangled photons generated by spontaneous parametric down conversion and initial correlations are introduced in a general fashion by means of a spatial light modulator. Finally, we take into account the Jaynes-Cummings model, showing how trace distance establishes general connections between correlation properties of initial total states and dynamical quantities that characterize the evolution of the open system.

*La storia non si snoda
come una catena
di anelli ininterrotta.*

*In ogni caso
molti anelli non tengono.*

*La storia non contiene
il prima e il dopo,
nulla che in lei borbotti
a lento fuoco.*

*La storia non è prodotta
da chi la pensa e neppure
da chi l'ignora. La storia
non si fa strada, si ostina,
detesta il poco a poco, non procede
né recede, si sposta di binario
e la sua direzione
non è nell'orario.*

*La storia non giustifica
e non deplora,
la storia non è intrinseca
perchè è fuori.*

*La storia non somministra
carezze o colpi di frusta.*

*La storia non è magistra
di niente che ci riguardi.*

*Accorgersene non serve
a farla più vera e più giusta.*

*La storia non è poi
la devastante ruspa che si dice.*

*Lascia sottopassaggi, cripte, buche
e nascondigli. C'è chi sopravvive.*

*La storia è anche benevola: distrugge
quanto più può: se esagerasse, certo
sarebbe meglio, ma la storia è a corto
di notizie, non compie tutte le sue vendette.*

*La storia gratta il fondo
come una rete a strascico
con qualche strappo e più di un pesce sfugge.*

*Qualche volta s'incontra l'ectoplasma
d'uno scampato e non sembra particolarmente felice.*

Ignora di essere fuori, nessuno glie n'ha parlato.

*Gli altri, nel sacco, si credono
più liberi di lui.*

E. Montale - La Storia

Acknowledgements

First of all, I would like to express all my gratitude to my supervisor, Bassano Vacchini. For everything he has taught me during these years, for his endless helpfulness.

My profound thanks to Ludovico Lanz, whose passion for fundamental physics has so deeply influenced my way of thinking.

My grateful thanks to Franco Gallone, for piquing my interest in quantum mechanics and to Alberto Barchielli, for introducing me to the world of stochastic calculus.

I want to thank Luciano Righi, for arousing my interest in physics.

I would like to thank the group of Applied Quantum Mechanics at Università degli Studi di Milano, in particular Davide Brivio, Simone Cialdi and Matteo Paris, for all the very helpful discussions and for their infinite patience in explaining me what we were actually doing in the lab!

I want to remember Federico Casagrande. I had the pleasure to experience his passion in teaching and his profound kindness.

I am very grateful to Heinz-Peter Breuer for his warm hospitality in Freiburg and for all the very fruitful discussions we had. I thank Govinda Clos, Manuel Gessner and all the guys in Freiburg.

I am very grateful to Jyrki Piilo for hosting me in Turku. I also thank him, Elsi-Mari Laine and Pinja Haikka for many interesting discussions.

I want to thank Mauro Paternostro, Laura Mazzola and all the guys in Belfast for their great hospitality and for the very enlightening discussions.

I would like to thank Valentino Liberali and Alberto Stabile for their willingness and for the helpful discussions.

I thank all the people I have known at Schools, Conferences and Workshops during my PhD, for everything I have learnt from them. And I thank all my friends and colleagues at the University of Milan, for the great times spent together.

Voglio ringraziare i miei genitori e mia sorella, per tutto il loro supporto e affetto. E per la loro pazienza per i miei "conticini".

Grazie Chiara, per dare un senso a tutto questo.

Contents

1	Introduction	1
2	Quantum dynamical maps	7
2.1	Basic concepts	8
2.1.1	Relevant operator spaces	8
2.1.2	Statistical formulation of quantum mechanics	10
2.1.3	Composite quantum systems and correlations in quantum states	12
2.2	States transformations and complete positivity	15
2.2.1	Linear maps on operator spaces	15
2.2.2	Kraus decomposition	19
2.2.3	Damping bases	22
2.2.4	An example: completely positive maps on the Bloch sphere	23
2.2.5	Completely positive maps and reduced dynamics of open quantum systems	25
3	Master equations	29
3.1	Local versus non-local description of reduced dynamics	30
3.1.1	Integrodifferential and time-local equations of motion from projection operator techniques	30
3.1.2	From linear maps to master equations	32
3.1.3	Trace and hermiticity preservation	36
3.2	Local versus non-local master equation for the dynamics of a two-level system	39
3.2.1	Jaynes-Cummings model and exact reduced dynamics	39
3.2.2	Exact time-convolutionless and Nakajima-Zwanzig master equations	41
3.2.3	Bath of harmonic oscillators at zero temperature	45
3.2.4	Perturbative expansion of the time-local master equation for a thermal bath	46
3.3	Master equations and complete positivity	49
3.3.1	Dynamical semigroups: the Gorini-Kossakowski-Sudarshan-Lindblad equation	50
3.3.2	Time-dependent Lindblad equation	53
3.3.3	Time-local master equations and complete positivity	55
3.3.4	From Lindblad structure to completely positive integrodifferential master equations	58

4	Non-Markovianity in classical stochastic processes and in quantum dynamics	61
4.1	Classical non-Markov processes	63
4.1.1	Markov processes	63
4.1.2	Semi-Markov processes	65
4.1.3	Examples	67
4.1.4	Conditional probability of a semi-Markov process	72
4.1.5	Kolmogorov distance	77
4.2	Quantum non-Markovian dynamics	78
4.2.1	Quantum semi-Markovian dynamics	79
4.2.2	Example: dephasing dynamics	80
4.2.3	Example: dissipative dynamics	86
4.2.4	Different definitions of non-Markovianity for stochastic processes and state dynamics	90
5	Initial correlations in the dynamics of open quantum systems	93
5.1	Different descriptions of open-system dynamics in the presence of initial correlations	95
5.1.1	Reduced maps and assignment maps	95
5.1.2	Generalized Lindblad structure	98
5.1.3	Trace-distance analysis of reduced dynamics with initial correlations . . .	101
5.2	Experimental investigation	103
5.2.1	Spontaneous parametric downconversion	104
5.2.2	Experimental setup	107
5.2.3	Trace distance evolution	108
5.3	Initial correlations in the Jaynes-Cummings model	112
5.3.1	Exact reduced evolution for generic initial state	112
5.3.2	Dynamics of the trace distance for pure or product total initial states . . .	113
5.3.3	Gibbs initial state: total amount of correlations	115
5.3.4	Gibbs initial state: time evolution of the trace distance	121
6	From Markovian dynamics on bipartite systems to non-Markovian dynamics on the subsystems	125
6.1	Collisional dynamics of a particle with translational and internal degrees of freedom	127
6.1.1	Physical model and master equation on the bipartite system	127
6.1.2	Generalized Lindblad structure on translational degrees of freedom . . .	128
6.1.3	Evolution in position representation	131
6.1.4	From generalized Lindblad structure to integrodifferential master equation	134
6.2	Non-Markovian features in the dynamics of translational degrees of freedom . . .	136
6.2.1	Nonexponential visibility reduction	136
6.2.2	Back flow of information	141
7	Conclusions	145
A	Quantum measurement	149

B One-parameter semigroups	153
C Trace distance	155
D General bound and non-convexity for correlations	159
E Measure of non-Markovianity	161
F Fourth order time-convolutionless master equation for the damped two-level system	165
Bibliography	169

Chapter 1

Introduction

The standard textbook presentation of quantum mechanics deals with closed quantum systems, whose evolution is described by means of a one-parameter group of unitary operators generated by a self-adjoint Hamiltonian. In the last few decades, an increasing effort has been put into developing the theory of open quantum systems [1], that is quantum systems in interaction with an environment. The reasons for this growing interest can be traced back to practical as well as fundamental questions.

Every concrete physical system is unavoidably affected by the interaction with an environment. Indeed, this is quite a generic statement, that can be applied to classical physics, as well. The crucial point is that the interaction of a quantum system with an environment strongly influences those features that cannot be enclosed into a classical description of the system. One of the most representative examples is given by the phenomenon that goes under the name of decoherence [2]. A quantum system interacting with an environment loses, typically on a very short time scale, the capability to exhibit superpositions among states belonging to a certain basis, ultimately depending on the specific form of the interaction between the open system and the environment. Thus, the study of open quantum systems has become of great relevance in all those areas of physics where the quantum nature of concrete physical systems in contact with an environment is taken into account, representing a basic resource. By way of example, one only needs to think of quantum information [3] as well as quantum optics [4].

As well known, quantum mechanics is an essentially statistical theory, meaning that all its predictions have a statistical character. The more recent statistical formulation of quantum mechanics, originated from the work by Ludwig [5, 6], Holevo [7] and Kraus [8], is based on the idea that quantum mechanics is a probability theory, significantly different from the classical one, rather than an extension of classical mechanics. The reproducible quantities of the theory are the relative frequencies according to which a large collection of identically prepared quantum systems triggers proper measurement apparatus. Indeed, a quantum system subjected to a coupling with a measurement apparatus represents an open system interacting with a macroscopic environment. The foundations of quantum mechanics are then deeply connected to the theory of open quantum systems through the notion of measurement process. Thus, it should not be surprising that many concepts and tools introduced within the statistical formulation of quantum mechanics are now at

the basis of the description of open quantum systems.

Moreover, the progressive loss of typical quantum features as a consequence of the interaction with an environment is commonly seen as a crucial step in the direction of a reconciliation between the quantum and the classical characterization of physical systems, since it provides a quantitative explanation of the absence of quantum effects above a certain size scale. Nevertheless, it should be kept in mind that the loss of quantum coherence for a microscopic system interacting with some macroscopic system is not the same as the classical behavior that macroscopic systems themselves actually exhibit. The latter, in fact, allows an objective description that cannot be explained simply in terms of decoherence [9, 10]. A more suitable characterization of macroscopic systems should then be taken into account. One of the possibilities is to base the description of macroscopic systems on quantum statistical mechanics, extended to non-equilibrium situations. This could lead to the appearance of an objective classical behavior for a proper subset of physical quantities, possibly yielding a unified description of microscopic and macroscopic systems [11, 12, 13].

By moving aside from the well-established field of closed quantum systems, where the unitary time evolution is directly fixed by the corresponding Hamiltonian operator, the description of the dynamics of quantum systems gets immediately more involved. Which are the most general equations of motion that provide a well-defined time evolution? How are these equations connected to the underlying microscopic description of the interaction between the open system and the environment? Is it possible to identify different classes of open-system dynamics on the basis of some physically as well as mathematically motivated criterion? What are the proper ways to quantitatively characterize the dynamics of open quantum systems under completely generic initial conditions? All these very basic questions are still at the moment only partially answered.

A result of paramount importance has been obtained by characterizing the class of dynamics described by completely positive quantum dynamical semigroups. The expression of the generators of such semigroups, that determines the equation of motion for the open system, has been fully identified [14, 15], providing a reference structure often called Lindblad equation. This class of dynamics is usually considered the quantum counterpart of classical homogeneous Markov processes. The main physical idea behind this correspondence is that in both cases the memory effects are negligible. In order to describe the dynamics of an open quantum system by disregarding at any time the influence of the previous interaction with the environment, one typically assumes that the characteristic time scale of the environment is much shorter than that of the open system. Indeed, there are many concrete physical systems where this condition is not satisfied, so that one has to look for a more general description of the dynamics. Just to mention an example, the development of technologies that access time-scales of the order of femtoseconds allows to observe phenomena in which non-Markovian features of the dynamics unavoidably play a fundamental role [16, 17]. As a consequence, in recent years a lot of research work has been devoted to quantum dynamics beyond the Markovian description. Apart from the explicit detailed treatment of many specific quantum systems where memory effects show up and the characterization of general classes of non-Markovian dynamics, efforts have been made to actually define what is meant by a non-Markovian quantum dynamics and to quantify the degree of non-Markovianity of a given quantum dynamics [18, 19, 20]. One of the main focuses of the present Thesis is precisely to investigate the very definition of non-Markovian quantum dynamics, with a particular emphasis

on its relations to the classical notion of non-Markovianity. The entire analysis is performed by means of two different ways to characterize the dynamics of open quantum systems. The first is based on the use of suitable evolution maps, often referred to as quantum dynamical maps [1], defined on the state space of the open system. The connections with the corresponding equations of motion are investigated, as well. The second approach has been introduced very recently [19, 21] and it relies on the idea that the dynamics of open systems can be described in terms of the information flow between the open system and the environment in the course of the dynamics. Such an information flow is quantitatively defined by means of trace distance, that measures the distinguishability between quantum states [3]. In particular, the dynamics of an open system is characterized by monitoring the evolution of the trace distance between couples of states of the open system that evolve from different initial total state.

The interaction between an open quantum system and an environment naturally induces correlations among these two systems. Nevertheless, it is usually assumed that the open system and the environment are uncorrelated at the initial time, thus assigning a very special status to the instant of time where one starts to monitor the evolution of the open system. From a physical point of view, this is not always justified, especially outside the weak coupling regime [22, 23, 24]. It is then of interest to extend the different approaches to open-system dynamics in order to include possible initial correlations. With respect to this, the definition of dynamical maps can become problematic. In fact, in the presence of initial system-environment correlations, contrary to the case of an uncorrelated initial state, there is not a unique way to define dynamical maps on the state space of the open system and their physical meaning can be established only inside proper domains, that are not easy to detect in an explicit way [25]. Furthermore, these maps turn out to depend on quantities related to the global system that cannot be generally accessed on concrete experimental situations. In this Thesis, the quantitative characterization of the open-system dynamics with initial correlations is presented from a different point of view [26]. Namely, this is based on the same approach previously mentioned in connection with the definition of non-Markovianity in quantum dynamics, relying on the analysis of trace-distance evolution as a consequence of an information flow between the open system and the environment. One of the main advantages of studying the dynamics of open quantum systems by means of trace distance consists in its clear and unambiguous experimental meaning, due to the fact that it only requires to perform measurements on the open system, without the need of any information about the total system or the structure of the interaction between the system and the environment. The first experimental investigation of the dynamics of an open quantum system in the presence of initial correlations with the environment has been recently achieved by the quantum optics group at the University of Milan [27].

Outline

This Thesis is organized as follows.

In Chapter 2, we introduce the basic concepts and tools used in the statistical formulation of quantum mechanics that will be at the basis of the entire subsequent analysis. In particular, we focus on transformation maps of quantum states, consisting in completely positive trace preserving linear maps. We first present such maps, as well as their properties and representations, in an abstract

way, while at the end of the chapter we show how they naturally provide a description of the dynamics of open quantum systems, if the open system and the environment are initially uncorrelated.

Chapter 3 concerns the equations of motion that can be associated with the evolution maps previously introduced and that are usually referred to as quantum master equations. We show to what extent the dynamics of open quantum systems can be described by both local and non-local in time master equations, also presenting some general methods to pass from one kind of equation to the other. This analysis is then applied to a two-level system interacting via Jaynes-Cummings Hamiltonian with the radiation field. We focus on the differences between the operator structure of local and non-local master equations, that generally depend on the initial state of the environment. Moreover, we face the problem of characterizing those equations of motion that guarantee a well-defined time evolution. After recalling basic results related to quantum dynamical semigroups and in particular the Lindblad equation, we present a local as well as a non-local generalization.

In Chapter 4, we discuss the conceptually different definitions used for the non-Markovianity of classical processes and quantum dynamics. We first deal with classical stochastic processes, focusing in particular, by means of a class of non-Markov processes, on the difference between the concepts of conditional probability and transition map. This clearly demonstrates that the Markovianity or non-Markovianity of a classical stochastic process cannot be accessed by the evolution of its one-point probability distribution only. We further show how recently introduced criteria for the non-Markovianity of quantum dynamics naturally induce analogous criteria on the dynamics of a classical one-point probability distribution. These are sufficient, but not necessary conditions for a classical stochastic process to be non-Markovian. The first criterion [19] is based on the analysis of the information flow between the open system and the environment, performed by means of the trace distance between pairs of open-system states. The second [20] is instead defined in terms of divisibility properties of the dynamical maps. The comparison between these two criteria and the related quantifiers of non-Markovianity is then performed in the quantum setting. Here, we take advantage of the definition of a class of non-Markovian quantum dynamics with a clear physical meaning as well as a direct connection with classical stochastic processes.

In Chapter 5, we deal with the dynamics of open quantum systems in the presence of initial system-environment correlations. We first briefly recall how the approach based on quantum dynamical maps can be applied to this situation, then we present a further generalization of the Lindblad equation, consisting in a system of homogeneous equations for proper dynamical variables. The rest of the chapter is focused on the different description of reduced dynamics with initial correlations, which is given in terms of trace-distance evolution. We first present the general theoretical scheme, and then we report its first experimental realization [27] through an all-optical apparatus, in which the dynamics of couples of entangled photons generated by spontaneous parametric down conversion has been investigated. Finally, we take once again the Jaynes-Cummings Hamiltonian into account, but now allowing for a fully generic initial total state. The trace-distance evolution of the open-system states evolving from the thermal state and its corresponding uncorrelated product state elucidates how the open system dynamically uncovers typical features of the initial correlations.

In Chapter 6, we consider a physical system associated with an infinite dimensional Hilbert space and we discuss its decoherence and non-Markovianity. Namely, we describe the dynamics of a

massive test particle with translational and internal degrees of freedom that interacts through collisions with a background low density gas. This is a representative model for the description of collisional decoherence. Under suitable approximations, the evolution of the massive particle can be characterized by a semigroup evolution. Nevertheless, there are situations where it is useful to focus on the dynamics of translational degrees of freedom alone, considering the internal degrees of freedom as part of the environment. A typical example is when the internal state of the massive particle is not resolved in visibility measurements. The resulting dynamics for the translational degrees of freedom can be given in terms of the generalization of the Lindblad equation introduced in Chapter 5, that allows to include initial system-environment correlations as well as non-Markovian effects. The latter are explicitly described by taking into account the evolution of both interferometric visibility and trace distance, which are shown to be strongly related for the model at hand.

This Thesis is built upon the material contained in [28, 29, 30, 31, 27] , as will be indicated in the various chapters more precisely.

Chapter 2

Quantum dynamical maps

This chapter provides a short introduction to basic concepts of quantum mechanics which will be employed throughout the entire Thesis. As stated in the Introduction, the quantum description of physical systems will be presented according to the statistical formulation of quantum mechanics. This approach turned out to be very useful for the characterization of quantum systems, closed as well as open, leading to the introduction of new concepts and tools which allowed a deeper understanding of the quantum description of reality, both from theoretical and experimental points of view. For more rigorous and detailed presentations of this topic the reader is referred to [32, 33, 1, 34, 13, 35], in addition to the works by Ludwig [5, 6], Holevo [7] and Kraus [8] already mentioned in the Introduction.

In quantum mechanics experiments are by necessity of statistical nature. The most simple setup can be typically described as a suitably devised macroscopic apparatus preparing the microscopical system one wants to study, that in turn triggers another macroscopic device designed to measure the value of a definite quantity. The predictions of the theory must be related to a large collection, or *ensemble*, of identically prepared quantum systems. The experimental quantity that has to be compared with the theory is the relative frequency according to which the elements of the ensemble trigger the registration apparatus. According to this picture, the states of the system are associated with preparation procedures, while the observables are associated with registration procedures.

Spaces of operators on Hilbert spaces are the natural mathematical framework where states as well as observables of physical systems are represented. Consequently, the evolution of a quantum system is characterized by means of maps taking values in these operator spaces. This applies to transformations due to a measurement performed on the system, as well as to dynamical evolutions. Indeed, the dynamics of closed systems is described by a very special kind of these maps; namely, unitary time evolutions that are uniquely fixed by a self-adjoint operator. Before focusing on the description of the dynamics of open quantum systems in the next chapters, we introduce here the general setting. The transformations of quantum states due to measurement processes can be described in terms of the so-called *instruments*, as briefly recalled in Appendix A.

In the first section, we present the mathematical objects representing the states as well as the observables of a quantum system. The set of quantum states of a physical system associated with

an Hilbert space \mathcal{H} is identified with the set of statistical operators on \mathcal{H} , while the definition of observable as positive operator-valued measure (POVM) consists in a map with values in the Banach space of bounded operators on \mathcal{H} . We first introduce the relevant sets of linear operators on \mathcal{H} , therefore connecting them to the statistical formulation of quantum mechanics. After that, we introduce the quantum description of composite systems and in particular the different kinds of preparation procedures that characterize product states, separable states and entangled states of a bipartite system. The notion of quantum discord is briefly presented, as well. We also introduce the concepts of partial trace and marginal states of a bipartite state, since they play a basic role in the theory of open quantum systems.

In the second section, we characterize the maps representing transformations of quantum states. This is firstly accomplished in an abstract way, by defining the space of linear maps on the operator spaces introduced in the first section. We describe different ways in order to represent these maps, thus introducing in a compact and unified way several techniques which are regularly used in the theory of open quantum systems. After that, we discuss general properties satisfied by those linear maps that properly describe transformations of quantum states, focusing on complete positivity. Finally, in the last part of the chapter, we introduce the concept of reduced dynamics, which provides a description of the evolution of an open quantum system interacting with an environment. We see how, under the hypothesis of an initial product state, this consists in a family of completely positive trace preserving linear maps.

2.1 Basic concepts

2.1.1 Relevant operator spaces

In quantum mechanics each physical system is associated with a separable Hilbert space \mathcal{H} ; we will denote its scalar product as $\langle \varphi | \psi \rangle$ and the induced norm as $\|\psi\| = \sqrt{\langle \psi | \psi \rangle}$, with $|\psi\rangle, |\varphi\rangle \in \mathcal{H}$. Let $\mathcal{T}(\mathcal{H})$ be the set of linear trace class operators on \mathcal{H} . A linear operator σ on \mathcal{H} belongs to the set $\mathcal{T}(\mathcal{H})$ if

$$\mathrm{Tr}[\sqrt{\sigma^\dagger \sigma}] < \infty. \quad (2.1)$$

The trace of an operator σ is defined as

$$\mathrm{Tr}[\sigma] = \sum_k \langle u_k | \sigma | u_k \rangle, \quad (2.2)$$

with $\{|u_k\rangle\}_{k=1,2,\dots}$ orthonormal basis in \mathcal{H} . The series in Eq. (2.2) does not depend on the basis and for $\sigma \in \mathcal{T}(\mathcal{H})$ it is absolutely convergent. The set $\mathcal{T}(\mathcal{H})$ is a Banach space with norm $\|\cdot\|_1$, which is called *trace norm*, defined by

$$\|\sigma\|_1 = \mathrm{Tr}[|\sigma|] = \mathrm{Tr}[\sqrt{\sigma^\dagger \sigma}] \quad \sigma \in \mathcal{T}(\mathcal{H}). \quad (2.3)$$

In addition to its central role in the definition of the set of quantum states, the trace norm can be directly exploited in order to characterize the dynamics of open quantum systems, as will be shown in Chapters 4 and 5.

The set $\mathcal{S}(\mathcal{H})$ of *statistical operators* on \mathcal{H} is given by the set of linear, semi-positive definite and with unit trace operators on \mathcal{H} ,

$$\mathcal{S}(\mathcal{H}) = \{\rho \in \mathcal{T}(\mathcal{H}) | \rho \geq 0, \|\rho\|_1 = 1\}, \quad (2.4)$$

where a semi-positive¹ definite operator $\rho \geq 0$ on an Hilbert space \mathcal{H} is a self-adjoint operator such that

$$\langle \psi | \rho | \psi \rangle \geq 0 \quad \forall |\psi\rangle \in \mathcal{H}. \quad (2.5)$$

Note that for any $\sigma \in \mathcal{T}(\mathcal{H})$ one has $\text{Tr}[\sigma] = \|\sigma\|_1$ if and only if σ is positive definite and that the set of self-adjoint operators in $\mathcal{T}(\mathcal{H})$ is the smallest linear space containing $\mathcal{S}(\mathcal{H})$. The set $\mathcal{S}(\mathcal{H})$ is convex, so that

$$\rho_k \in \mathcal{S}(\mathcal{H}), \quad \lambda_k \geq 0 \quad \sum_k \lambda_k = 1 \Rightarrow \sum_k \lambda_k \rho_k \in \mathcal{S}(\mathcal{H}). \quad (2.6)$$

One dimensional projectors are the extremal points of this set, that is the elements that do not admit any further demixture: if $\rho = |\psi\rangle\langle\psi|$ with $\|\psi\| = \sqrt{\langle\psi|\psi\rangle} = 1$, then

$$\rho = \lambda\rho_1 + (1 - \lambda)\rho_2 \quad 0 < \lambda < 1 \quad \rho_1, \rho_2 \in \mathcal{S}(\mathcal{H}) \Rightarrow \rho = \rho_1 = \rho_2. \quad (2.7)$$

The dual space to $\mathcal{T}(\mathcal{H})$ consists of all the linear bounded operators on \mathcal{H} and will be denoted as $\mathcal{B}(\mathcal{H})$. This is a Banach space with norm $\|\cdot\|_\infty$ defined through

$$\|A\|_\infty = \sup_{\|\psi\|=1} \|A|\psi\rangle\|, \quad (2.8)$$

with $|\psi\rangle \in \mathcal{H}$ and $A \in \mathcal{B}(\mathcal{H})$. The form of duality between $\mathcal{B}(\mathcal{H})$ and $\mathcal{T}(\mathcal{H})$ is given by the trace:

$$\begin{aligned} \text{Tr} : \mathcal{B}(\mathcal{H}) \times \mathcal{T}(\mathcal{H}) &\rightarrow \mathbb{C}; \\ (A, \sigma) &\rightarrow \text{Tr}[A^\dagger \sigma]. \end{aligned} \quad (2.9)$$

The trace in Eq. (2.9) is well defined since the product of a bounded operator and a trace class operator is a trace class operator [36]. Moreover, it holds the relation

$$|\text{Tr}[A\sigma]| \leq \|A\|_\infty \|\sigma\|_1. \quad (2.10)$$

Finally, let us introduce the set of Hilbert-Schmidt operators on \mathcal{H} , which will be denoted as $\mathcal{D}(\mathcal{H})$, i.e. the set of linear operators X on \mathcal{H} such that

$$\text{Tr}[X^\dagger X] < \infty. \quad (2.11)$$

The set $\mathcal{D}(\mathcal{H})$ is a Banach space with norm $\|\cdot\|_2$ defined by

$$\|X\|_2 = \sqrt{\text{Tr}[X^\dagger X]} \quad X \in \mathcal{D}(\mathcal{H}). \quad (2.12)$$

¹From now on, we will use the more common expression positive definite operator.

Since for every linear operator A on \mathcal{H} it holds

$$\|A\|_\infty \leq \|A\|_2 \leq \|A\|_1, \quad (2.13)$$

one has $\mathcal{T}(\mathcal{H}) \subset \mathcal{D}(\mathcal{H}) \subset \mathcal{B}(\mathcal{H})$. The duality relation in Eq. (2.9) induces a scalar product on $\mathcal{T}(\mathcal{H})$ as well as on $\mathcal{D}(\mathcal{H})$, the *Hilbert-Schmidt* scalar product:

$$\langle \sigma, \tilde{\sigma} \rangle = \text{Tr}[\sigma^\dagger \tilde{\sigma}], \quad (2.14)$$

with $\sigma, \tilde{\sigma} \in \mathcal{T}(\mathcal{H})$ or $\sigma, \tilde{\sigma} \in \mathcal{D}(\mathcal{H})$; note that this scalar product is well-defined also on $\mathcal{D}(\mathcal{H})$ since the product of two Hilbert-Schmidt operators is a trace class operator. Indeed, $\mathcal{T}(\mathcal{H})$ is not generally an Hilbert space, while $\mathcal{D}(\mathcal{H})$ is an Hilbert space with respect to the scalar product defined in Eq. (2.14), since it is a Banach space with respect to the corresponding induced norm, see Eq. (2.12).

2.1.2 Statistical formulation of quantum mechanics

The set of statistical operators $\mathcal{S}(\mathcal{H})$ represents the set of quantum states of the physical system associated with the Hilbert space \mathcal{H} [37]. According to the statistical formulation of quantum mechanics, a statistical operator ρ provides a complete characterization of an ensemble of quantum systems prepared in a specific way, typically by a suitably devised macroscopic apparatus. The set $\mathcal{S}(\mathcal{H})$ is convex and one dimensional projectors are its extremal points, referred to as *pure states*, see Eqs. (2.6) and (2.7). On the other hand, a state ρ which is not pure, a *mixed state*, in general admits infinitely many ways to be written as a convex combination of other states. Among the different decompositions, every statistical operator ρ can be expressed as a convex combination of pure orthogonal states. Since a generic statistical operator ρ has a point spectrum of eigenvalues $\lambda_k \geq 0$ and 0 is the only possible accumulation point², one can always write

$$\rho = \sum_k \lambda_k |\psi_k\rangle\langle\psi_k| \quad \lambda_k \geq 0 \quad \sum_k \lambda_k = 1; \quad \langle\psi_{k'}|\psi_k\rangle = \delta_{k,k'}, \quad (2.15)$$

with λ_k and $|\psi_k\rangle$, respectively, eigenvalues and eigenvectors of ρ .

As already mentioned in the introduction to this chapter, observables are instead associated with registration procedures. Their mathematical representatives consist in positive operator-valued measures (POVMs), which are maps with values in the set of bounded operators. Let Ω be the set of the possible outcomes of a measurement performed on a given observable and let $\mathfrak{A}(\Omega)$ be a σ -algebra over Ω . A POVM F is a map associating to each element $M \in \mathfrak{A}(\Omega)$, a bounded operator $F(M) \in \mathcal{B}(\mathcal{H})$, called *effect*, i.e.,

$$\begin{aligned} F(\cdot) : \mathfrak{A}(\Omega) &\rightarrow \mathcal{B}(\mathcal{H}) \\ M &\rightarrow F(M), \end{aligned} \quad (2.16)$$

²This is a consequence of the general theory on compact self-adjoint operators on Hilbert spaces (every trace class operator is compact [36]): the nonzero eigenvalues have finite dimensional eigenspaces and, in the case of an infinite dimensional Hilbert space, the sequence of eigenvalues converges to 0.

in a way such that

$$\begin{aligned}
 0 &\leq F(M) \leq 1 \\
 F(\emptyset) &= 0 \quad F(\Omega) = \mathbb{1} \\
 F(\cup_i M_i) &= \sum_i F(M_i) \quad \text{if } M_i \cap M_j = \emptyset \text{ for } i \neq j.
 \end{aligned} \tag{2.17}$$

Note that the effect $F(M)$ is not necessarily a projection operator, since the idempotence relation $F^2(M) = F(M)$ is not requested. If this further condition holds for all $M \in \mathfrak{A}(\Omega)$ one has a projection-valued measure (PVM). The spectral theorem establishes a one-to-one correspondence between the set of PVMs and the set of self-adjoint operators on \mathcal{H} , so that one can recover the standard definition of observable as self-adjoint operator.

The duality relation expressed by Eq. (2.9) provides the statistical formula allowing to compare the theory with the experiment: given a system prepared in the state ρ , the probability that a quantity described by the POVM F takes value in M is

$$\mu_\rho^F(M) = \text{Tr}[\rho F(M)]. \tag{2.18}$$

Note that the properties of trace class operators and POVMs ensure that $\mu_\rho^F(M)$ is a number between 0 and 1 and that the map

$$\begin{aligned}
 \mu_\rho^F(\cdot) : \mathfrak{A}(\Omega) &\rightarrow [0, 1]; \\
 M &\rightarrow \mu_\rho^F(M) = \text{Tr}[\rho F(M)]
 \end{aligned} \tag{2.19}$$

is a classical probability measure. The crucial difference with respect to classical probability theory is that there is not a common probability density allowing to express the probability measures of all the observables.

The basic relation in Eq. (2.18) enables the following interpretation to the possibly infinite ways to write a mixed state as a convex combination of other states. The different demixtures do generally correspond to preparation procedures performed with different devices and which are incompatible, in the sense that they cannot be accomplished together, but which lead to the same statistics in any subsequent experiment, thus being physically indistinguishable. In fact, since they are all represented by the same state ρ , the probabilities they assign to the different observables according to Eq.(2.18) are the same. Thus, more precisely, a statistical operator ρ is to be understood as the mathematical representative of an *equivalence class* of preparation procedures. To give an example, the spectral decomposition in Eq. (2.15) indicates that an ensemble made of a large number, let us say n , of quantum systems has been prepared from the mixture of different ensembles of identically prepared quantum systems, each of these ensembles with $n_k = p_k n$ elements and described by the pure state $|\psi_k\rangle$.

In an analogous way, according to the statistical formulation of quantum mechanics, an observable is to be understood as the mathematical representative of an equivalence class of registration procedures. In fact, different and generally incompatible macroscopic devices can be used to measure the same physical quantity. From a mathematical point of view, this is connected to the possibility of introducing different *instruments* for the same POVM, see Appendix A.

Finally, note that by means of Eq. (2.18) and the spectral theorem, one gets the usual formula for the mean value $\langle H \rangle$ of an observable represented by a self-adjoint operator H , given that the system is in the state ρ :

$$\langle H \rangle = \text{Tr}[\rho H]. \quad (2.20)$$

2.1.3 Composite quantum systems and correlations in quantum states

The notion of composite quantum system stands at the very foundation of the theory of open quantum systems. Indeed, an open system and the corresponding environment are the two parts of a composite system. Then, it is worth recalling here the main features of the quantum description of composite systems.

Consider two physical systems associated with \mathcal{H}_1 and \mathcal{H}_2 , respectively, and representing the two parts of a composite system. The Hilbert space associated with the total system composed by the two subsystems is given by the tensor product $\mathcal{H} = \mathcal{H}_1 \otimes \mathcal{H}_2$. Fixed two orthonormal bases $\{|\psi_j\rangle\}$ and $\{|\varphi_k\rangle\}$ in \mathcal{H}_1 and \mathcal{H}_2 , respectively, a generic element of \mathcal{H} may be written as

$$|\psi\rangle = \sum_{jk} c_{jk} |\psi_j\rangle \otimes |\varphi_k\rangle, \quad (2.21)$$

so that the set $\{|\psi_j\rangle \otimes |\varphi_k\rangle\}$ is a basis in the tensor product Hilbert space \mathcal{H} . On the same footing, given two linear operators, ω on \mathcal{H}_1 and χ on \mathcal{H}_2 , one can define their tensor product $\omega \otimes \chi$ by means of the relation

$$(\omega \otimes \chi)(|\psi\rangle \otimes |\varphi\rangle) = \omega|\psi\rangle \otimes \chi|\varphi\rangle, \quad (2.22)$$

and then by linear extension on the whole \mathcal{H} . Any operator O on \mathcal{H} can be written as

$$O = \sum_k \omega_k \otimes \chi_k. \quad (2.23)$$

The set of states of the composite system is $\mathcal{S}(\mathcal{H}_1 \otimes \mathcal{H}_2)$. The simplest example of such a state is given by the product state

$$\varrho = \rho \otimes \sigma, \quad (2.24)$$

with $\rho \in \mathcal{S}(\mathcal{H}_1)$ and $\sigma \in \mathcal{S}(\mathcal{H}_2)$, physically representing two uncorrelated subsystems. This means that a product state can be prepared by acting locally and in a fully independent way on the different parts of the composite system. If also the registration procedure is performed independently on the two subsystems, so that it is described by effects of the form $A \otimes B$, the probabilities on the two subsystems factorize since, see Eq. (2.18),

$$\text{Tr}[\varrho(A \otimes B)] = \text{Tr}[(\rho \otimes \sigma)(A \otimes B)] = \text{Tr}[\rho A] \text{Tr}[\sigma B]. \quad (2.25)$$

This is simply the case of two independent experiments performed at the same time on the two subsystems.

A more involved situation occurs if the preparation procedure consists in local operations performed on the two subsystems plus a classical communication between them, so that one introduces correlations between the two parts in a classical way. The states which are prepared in this

way can be represented by statistical operators of the form [38]

$$\varrho = \sum_{k=1}^d p_k \rho_k \otimes \sigma_k \quad p_k > 0 \quad \sum_k p_k = 1, \quad (2.26)$$

where $\rho_k \in \mathcal{S}(\mathcal{H}_1)$, $\sigma_k \in \mathcal{S}(\mathcal{H}_2)$ and $d < \infty$. In particular, a state ϱ on a bipartite Hilbert space $\mathcal{H} = \mathcal{H}_1 \otimes \mathcal{H}_2$ is called *separable* if and only if it can neither be represented nor approximated as in Eq. (2.26). The states which are not separable are called *entangled*. Entanglement is a distinctive feature of quantum mechanics [39, 40], playing a central role in the foundations of quantum mechanics, as well as being a key resource for quantum-information sciences. A lot of questions connected to entanglement are still open and highly debated, e.g. the problem of establishing whether an assigned state ϱ can be written in the form as in Eq. (2.26) or how to quantify entanglement, but they go beyond the scope of this work (for a review about entanglement and its applications to quantum communication see [41]). However, it is worth recalling here that the characterization of entanglement can be fully accomplished in the case of pure states³. For any pure state $|\phi\rangle$ on a bipartite Hilbert space there exist orthonormal bases, the Schmidt bases, $\{|\chi_{1,k}\rangle\}$ and $\{|\chi_{2,k}\rangle\}$ in \mathcal{H}_1 and \mathcal{H}_2 , respectively, such that $|\phi\rangle$ can be written according to the *Schmidt decomposition* [3]

$$|\phi\rangle = \sum_{k=1}^N \sqrt{p_k} |\chi_{1,k}\rangle \otimes |\chi_{2,k}\rangle \quad p_k > 0 \quad \sum_k p_k = 1, \quad (2.27)$$

where N is the minimum between the dimensions of \mathcal{H}_1 and \mathcal{H}_2 . The Schmidt rank, i.e. the number of non-zero Schmidt coefficients $\sqrt{p_k}$, is invariant with respect to unitary transformations of the form $U \otimes V$ and then it does not depend on the particular Schmidt bases chosen, but it is uniquely associated with the given state $|\phi\rangle$. A pure bipartite state $|\phi\rangle$ is entangled if and only if it cannot be written as a product state $|\psi\rangle \otimes |\varphi\rangle$ and then if and only if its Schmidt rank is higher than 1. On the other hand, given a finite N in Eq. (2.27), a state is said to be *maximally entangled* if its Schmidt coefficients are all equal to $N^{-1/2}$, i.e. if it is of the form

$$|\phi\rangle_{\text{ME}} = \frac{1}{\sqrt{N}} \sum_{k=1}^N |\chi_{1,k}\rangle \otimes |\chi_{2,k}\rangle. \quad (2.28)$$

The definition of entangled states, which distinguishes classical from quantum correlations on the basis of different kinds of preparation procedures, has been recently refined by the introduction of the notion of quantum discord [42, 43], which is instead focused on the effects of local measurement performed on the system. Namely, a state has a vanishing quantum discord if there exists a local basis for one of the subsystems in which the observer can perform measurements without modifying the state. The latter condition is a general property of classical systems, but it is not usually satisfied in quantum mechanics, which motivates the definition. Quantum discord is

³At least in the bipartite case; one can see the above mentioned reference also for a discussion of multipartite entanglement, i.e. the entanglement related to composite quantum systems with more than two parts, associated with Hilbert spaces of the form $\mathcal{H}_1 \otimes \mathcal{H}_2 \otimes \dots \otimes \mathcal{H}_n$.

asymmetric under the change of the two subsystems. In particular, if the local measurements are performed on the first subsystem, a state with zero discord is of the form

$$\varrho = \sum_k p_k |v_k\rangle\langle v_k| \otimes \sigma_k, \quad (2.29)$$

with $0 \leq p_k \leq 1$, $\sum_k p_k = 1$, $\{|v_k\rangle\}_{k=1,2,\dots}$ a basis in \mathcal{H}_1 and σ_k statistical operators on \mathcal{H}_2 . In fact, one can see [43] that a state ϱ can be written as in Eq. (2.29) if and only if it satisfies the following invariance:

$$\varrho = \sum_k \Pi_k \varrho \Pi_k, \quad (2.30)$$

with $\Pi_k = |v_k\rangle\langle v_k| \otimes \mathbb{1}$ rank-one projectors acting in a non-trivial way on the first subsystem. Thus, according to (A.12), a zero-discord state is not modified by a non-selective measurement of an observable of the first subsystem associated with the non-degenerate self-adjoint operator with eigenvectors $\{|v_k\rangle\}_{k=1,2,\dots}$. Indeed, a similar analysis can be done for states that have vanishing discord with respect to the second subsystem, and a symmetrized version of quantum discord can be introduced, thus allowing for the generalization to multipartite scenario [44]. As it clearly appears from Eqs. (2.26) and (2.29), states with vanishing discord form a subset of separable states and there are separable states with nonzero discord. It has been shown [45] that the set of zero-discord states has measure zero.

Partial trace

If one is only interested in observables related to one subsystem, that is only in operators of the form $A \otimes \mathbb{1}$ (or, equivalently, $\mathbb{1} \otimes B$), it is convenient to introduce the statistical operator, which is referred only to the subsystem of interest, defined by taking the *partial trace* of the total state ϱ :

$$\rho_1 \equiv \text{tr}_2 \varrho, \quad (2.31)$$

where $\rho_1 \in \mathcal{S}(\mathcal{H}_1)$ since $\varrho \in \mathcal{S}(\mathcal{H}_1 \otimes \mathcal{H}_2)$ and tr_2 indicates the partial trace performed over the second Hilbert space. Given a basis $\{|u_k\rangle\}$ in \mathcal{H}_2 and $|\psi\rangle, |\zeta\rangle \in \mathcal{H}_1$, the partial trace in Eq. (2.31) means that

$$\langle \psi | \rho_1 | \zeta \rangle = \langle \psi | \text{tr}_2 \varrho | \zeta \rangle = \sum_k (\langle u_k | \otimes \langle \psi |) \varrho (|u_k\rangle \otimes |\zeta\rangle). \quad (2.32)$$

A completely specular relation holds for the state $\rho_2 = \text{tr}_1 \varrho \in \mathcal{S}(\mathcal{H}_2)$. The two states ρ_1 and ρ_2 are often called *marginal* states with respect to the total state ϱ . From Eq. (2.32) it is in fact clear the analogy with the classical marginal probability distributions obtained from a joint probability distribution. From a physical point of view, the partial trace tr_2 describes the average performed over the degrees of freedom of the system associated with \mathcal{H}_2 . The statistical operator defined in Eq. (2.31) allows to describe the whole statistic of the first subsystem: given an effect of the form $A \otimes \mathbb{1}$, the probability associated with it by means of Eq. (2.18) can be calculated as

$$\text{Tr}[\varrho(A \otimes \mathbb{1})] = \text{tr}_1[\rho_1 A]. \quad (2.33)$$

It can be shown [3] that the partial trace is the unique function $f : \mathcal{S}(\mathcal{H}_1 \otimes \mathcal{H}_2) \rightarrow \mathcal{S}(\mathcal{H}_1)$ such that $\text{tr}_1[f(\varrho)A] = \text{Tr}[\varrho(A \otimes \mathbb{1})]$ for any $\varrho \in \mathcal{S}(\mathcal{H})$ and $A \in \mathcal{B}(\mathcal{H})$, so that this way of describing the state of subsystems is the only compatible with the statistical formulation presented in the previous paragraph.

As a first application of the partial trace, one can immediately see that the Schmidt decomposition of a pure bipartite state, see Eq. (2.27), yields

$$\begin{aligned}\rho_1 = \text{tr}_2[|\phi\rangle\langle\phi|] &= \sum_k p_k |\chi_{1,k}\rangle\langle\chi_{1,k}| \\ \rho_2 = \text{tr}_1[|\phi\rangle\langle\phi|] &= \sum_k p_k |\chi_{2,k}\rangle\langle\chi_{2,k}|,\end{aligned}\tag{2.34}$$

so that the marginal states of a pure bipartite state have the same eigenvalues. Furthermore, by means of the Schmidt decomposition, one can see that if at least one of the marginal states is pure, then the total state ϱ has to be a product state, that is

$$\rho_1 = \text{tr}_2[\varrho] = |\psi\rangle\langle\psi| \quad \text{or} \quad \rho_2 = \text{tr}_1[\varrho] = |\varphi\rangle\langle\varphi| \implies \varrho = \rho_1 \otimes \rho_2,\tag{2.35}$$

with $|\psi\rangle \in \mathcal{H}_1$ and $|\varphi\rangle \in \mathcal{H}_2$, for a proof see [46]. Finally, note that the set of states in $\mathcal{S}(\mathcal{H}_1 \otimes \mathcal{H}_2)$ which have the same marginals ρ_1 and ρ_2 is a convex set. This set of course includes the product state obtained from the marginals of ϱ , i.e.

$$\rho_1 \otimes \rho_2 \quad \rho_1 = \text{tr}_2[\varrho] \quad \rho_2 = \text{tr}_1[\varrho].\tag{2.36}$$

This kind of states can be used in order to study the dynamics of open quantum systems in the presence of initial correlations between the open system and the environment, as will be shown in Chapter 5.

2.2 States transformations and complete positivity

2.2.1 Linear maps on operator spaces

Let us now consider the mathematical representatives of transformations of quantum states, that is, linear maps on the previously introduced operator spaces. First, we are going to describe one step transformations without directly connecting them to any specific evolution process. In this and in the next two paragraphs we describe in an abstract way how to represent a linear map and when it properly describes a transformation of quantum states. The connection with the dynamics of open quantum systems will be given in the last paragraph of the section. The connection with measurement processes on quantum systems is briefly presented in Appendix A. For simplicity, we are moving to the finite-dimensional case, i.e. we are assuming $\mathcal{H} = \mathbb{C}^N$. All the linear operators on finite-dimensional Hilbert spaces are bounded, so that the three Banach spaces presented in the previous section coincide with the space of linear operators on \mathbb{C}^N , which will be denoted as $\mathcal{L}(\mathbb{C}^N)$.

Consider the Banach space⁴ $\mathcal{L}(\mathbb{C}^N)$ of linear operators on the finite-dimensional Hilbert space $\mathcal{H} = \mathbb{C}^N$. Note that $\mathcal{L}(\mathbb{C}^N)$ equipped with the Hilbert-Schmidt scalar product defined in Eq. (2.14) is an Hilbert space. Every linear map Λ on $\mathcal{L}(\mathbb{C}^N)$ is thus a linear operator on an Hilbert space. As such, we will say that a linear map Λ is a self-adjoint operator on $\mathcal{L}(\mathbb{C}^N)$ if it equals its adjoint operator Λ^\dagger , defined through

$$\langle \Lambda^\dagger(\chi), \omega \rangle = \langle \chi, \Lambda(\omega) \rangle \quad \forall \chi, \omega \in \mathcal{L}(\mathbb{C}^N), \quad (2.37)$$

where $\langle \chi, \omega \rangle$ indicates the Hilbert-Schmidt scalar product between χ and ω , see Eq. (2.14). Furthermore, we will say that a self-adjoint operator Λ is positive definite if it satisfies the condition expressed in Eq. (2.5); explicitly,

$$\langle \omega, \Lambda(\omega) \rangle \geq 0 \quad \forall \omega \in \mathcal{L}(\mathbb{C}^N). \quad (2.38)$$

Note that we have taken advantage of the fact that $\mathcal{L}(\mathbb{C}^N)$ is a finite-dimensional Hilbert space. More in general, considering a linear operator Λ acting on the set $\mathcal{T}(\mathcal{H})$ of trace class operators on the infinite-dimensional Hilbert space \mathcal{H} , one would instead introduce the concept of *dual map* on the space $\mathcal{B}(\mathcal{H})$, dual to $\mathcal{T}(\mathcal{H})$. The map Λ^* dual to Λ is defined as

$$(\Lambda^*(A), \sigma) = (A, \Lambda(\sigma)) \quad A \in \mathcal{B}(\mathcal{H}) \quad \sigma \in \mathcal{T}(\mathcal{H}), \quad (2.39)$$

where $(A, \sigma) = \text{Tr}[A^\dagger \sigma]$ indicates the duality relation between $\mathcal{B}(\mathcal{H})$ and $\mathcal{T}(\mathcal{H})$, see Eq. (2.9). In the case of a finite dimensional Hilbert space \mathcal{H} the definition of dual map reduces to that of adjoint operator in Eq. (2.37).

Let $\{\sigma_\alpha\}_{\alpha=1, \dots, N^2}$ be a basis in $\mathcal{L}(\mathbb{C}^N)$, orthonormal with respect to the Hilbert-Schmidt scalar product:

$$\langle \sigma_\beta, \sigma_\alpha \rangle = \text{Tr}[\sigma_\beta^\dagger \sigma_\alpha] = \delta_{\alpha\beta}. \quad (2.40)$$

Then, every linear operator Λ on the Hilbert space $\mathcal{L}(\mathbb{C}^N)$, with scalar product given by Eq. (2.14), can be expressed by the relation

$$\Lambda(\omega) = \sum_{\alpha\beta} \Lambda_{\alpha\beta} \text{Tr}[\sigma_\beta^\dagger \omega] \sigma_\alpha \quad \omega \in \mathcal{L}(\mathbb{C}^N), \quad (2.41)$$

with

$$\Lambda_{\alpha\beta} = \langle \sigma_\alpha, \Lambda(\sigma_\beta) \rangle = \text{Tr}[\sigma_\alpha^\dagger \Lambda(\sigma_\beta)]. \quad (2.42)$$

The matrix with entries as the coefficients $\Lambda_{\alpha\beta}$ in Eq. (2.42) will be indicated as Λ , i.e. by means of Sans serif typeface. Indeed, Λ is a self-adjoint operator on $\mathcal{L}(\mathbb{C}^N)$ if and only if the corresponding matrix Λ is hermitian and it is positive definite if and only if the hermitian matrix Λ is positive-definite.

Let us now assume a different perspective, by directly taking into account the space of linear maps on $\mathcal{L}(\mathbb{C}^N)$, which will be denoted as $\mathcal{LL}(\mathbb{C}^N)$. Note that $\mathcal{L}(\mathbb{C}^N)$ can be identified with the

⁴All the norms on a finite-dimensional normed space are equivalent [36]. Two norms $\|\cdot\|_1$ and $\|\cdot\|_2$ on a normed space \mathcal{V} are equivalent if there are positive constants C and C' such that, for all $v \in \mathcal{V}$, it holds $C\|v\|_1 \leq \|v\|_2 \leq C'\|v\|_1$.

algebra of $N \times N$ complex matrices M_N , while $\mathcal{LL}(\mathbb{C}^N)$ can be identified with M_{N^2} . Moreover, $\mathcal{LL}(\mathbb{C}^N)$ is an Hilbert space equipped with the following scalar product:

$$\langle\langle \Xi, \Lambda \rangle\rangle = \sum_{\alpha} \langle \Xi(\sigma_{\alpha}), \Lambda(\sigma_{\alpha}) \rangle = \sum_{\alpha} \text{Tr} [\Xi(\sigma_{\alpha})^{\dagger} \Lambda(\sigma_{\alpha})] \quad \Xi, \Lambda \in \mathcal{LL}(\mathbb{C}^N), \quad (2.43)$$

where $\{\sigma_{\alpha}\}_{\alpha=1, \dots, N^2}$ is an orthonormal basis in $\mathcal{L}(\mathbb{C}^N)$. Two different orthonormal bases in $\mathcal{LL}(\mathbb{C}^N)$, denoted as $\{E_{\alpha\beta}\}_{\alpha, \beta=1, \dots, N^2}$ and $\{F_{\alpha\beta}\}_{\alpha, \beta=1, \dots, N^2}$, can be introduced through the relations [47, 48]

$$E_{\alpha\beta}(\omega) = \sigma_{\alpha} \text{Tr} [\sigma_{\beta}^{\dagger} \omega], \quad (2.44)$$

$$F_{\alpha\beta}(\omega) = \sigma_{\alpha} \omega \sigma_{\beta}^{\dagger}, \quad (2.45)$$

where $\omega \in \mathcal{L}(\mathbb{C}^N)$. It is easy to see that the elements of these two bases are actually orthonormal, i.e. that

$$\langle\langle E_{\alpha\beta}, E_{\alpha'\beta'} \rangle\rangle = \langle\langle F_{\alpha\beta}, F_{\alpha'\beta'} \rangle\rangle = \delta_{\alpha\alpha'} \delta_{\beta\beta'}. \quad (2.46)$$

The second equality in Eq. (2.46) can be proved by using

$$\sum_{\alpha} \sigma_{\alpha}^{\dagger} \omega \sigma_{\alpha} = \mathbb{1} \text{Tr}[\omega] \quad \omega \in \mathcal{L}(\mathbb{C}^N), \quad (2.47)$$

as shown in the Lemma 2.2 in [14].

Now, any linear map $\Lambda \in \mathcal{LL}(\mathbb{C}^N)$ can be expanded on each of the two bases. Let us begin with $\{E_{\alpha\beta}\}_{\alpha, \beta=1, \dots, N^2}$:

$$\Lambda(\omega) = \sum_{\alpha\beta} \Lambda_{\alpha\beta} E_{\alpha\beta}(\omega) = \sum_{\alpha\beta} \Lambda_{\alpha\beta} \text{Tr} [\sigma_{\beta}^{\dagger} \omega] \sigma_{\alpha} \quad \omega \in \mathcal{L}(\mathbb{C}^N), \quad (2.48)$$

with

$$\begin{aligned} \Lambda_{\alpha\beta} &= \langle\langle E_{\alpha\beta}, \Lambda \rangle\rangle = \sum_{\gamma} \text{Tr} [E_{\alpha\beta}(\sigma_{\gamma})^{\dagger} \Lambda(\sigma_{\gamma})] = \sum_{\gamma} \text{Tr} [(\sigma_{\alpha} \text{Tr} [\sigma_{\beta}^{\dagger} \sigma_{\gamma}])^{\dagger} \Lambda(\sigma_{\gamma})] \\ &= \text{Tr} [\sigma_{\alpha}^{\dagger} \Lambda(\sigma_{\beta})]. \end{aligned} \quad (2.49)$$

Comparing Eqs. (2.48) and (2.49) with Eqs. (2.41) and (2.42), one can conclude that the expansion on the basis $\{E_{\alpha\beta}\}_{\alpha, \beta=1, \dots, N^2}$ does correspond to the expansion of Λ regarded as a linear operator on the Hilbert space $\mathcal{L}(\mathbb{C}^N)$. Indeed, the elements of the matrix Λ previously introduced can be equivalently associated with the definition in Eq. (2.42) and with that in Eq. (2.49).

Taking into account the basis $\{F_{\alpha\beta}\}_{\alpha, \beta=1, \dots, N^2}$ as in Eq. (2.45), one has instead the following expansion:

$$\Lambda(\omega) = \sum_{\alpha\beta} \Lambda'_{\alpha\beta} F_{\alpha\beta}(\omega) = \sum_{\alpha\beta} \Lambda'_{\alpha\beta} \sigma_{\alpha} \omega \sigma_{\beta}^{\dagger} \quad \omega \in \mathcal{L}(\mathbb{C}^N), \quad (2.50)$$

with

$$\begin{aligned}\Lambda'_{\alpha\beta} &= \langle\langle F_{\alpha\beta}, \Lambda \rangle\rangle = \sum_{\gamma} \text{Tr} \left[F_{\alpha\beta}(\sigma_{\gamma})^{\dagger} \Lambda(\sigma_{\gamma}) \right] \\ &= \sum_{\gamma} \text{Tr}[\sigma_{\beta} \sigma_{\gamma}^{\dagger} \sigma_{\alpha}^{\dagger} \Lambda(\sigma_{\gamma})].\end{aligned}\quad (2.51)$$

These two representations of linear maps are regularly used in the study of the dynamics of open quantum systems and will be often encountered in the following. The representation given by Eqs. (2.50) and (2.51) allows to determine in a direct way if the linear map Λ is completely positive, as will be discussed in the next paragraph. On the other hand, the representation given by Eqs. (2.48) and (2.49) is well suited for the composition of maps. Indeed, this is a direct consequence of the equivalence between this representation and that associated, through Eqs. (2.41) and (2.42), with Λ as linear operator on $\mathcal{L}(\mathbb{C}^N)$. If $\Lambda = \sum_{\alpha\beta} \Lambda_{\alpha\beta} E_{\alpha\beta}$ and $\Xi = \sum_{\alpha\beta} \Xi_{\alpha\beta} E_{\alpha\beta}$, then the map $\Phi = \Lambda \circ \Xi$ can be expanded as $\Phi = \sum_{\alpha\beta} \Phi_{\alpha\beta} E_{\alpha\beta}$, where the respective coefficient matrices fulfill $\Phi = \Lambda \Xi$. This turns out to be very useful in order to connect the generator of a given dynamics to the corresponding evolution map, as will be shown in Chapter 3.

Any orthonormal basis $\{|u_k\rangle\}_{k=1,\dots,N}$ in \mathbb{C}^N naturally induces an orthonormal basis in $\mathcal{L}(\mathbb{C}^N)$ by means of (with the convention on the indices $\alpha \leftrightarrow (k, l)$)

$$\sigma_{\alpha} = e_{kl} \equiv |u_k\rangle\langle u_l|. \quad (2.52)$$

Then, by introducing the notation

$$\Lambda_{rs, r's'} = \langle u_r | \Lambda(|u_{r'}\rangle\langle u_{s'}|) |u_s\rangle, \quad (2.53)$$

where the scalar product $\langle \cdot, \cdot \rangle$ is now referred to \mathbb{C}^N , it is easy to see that the coefficients of the two representations of a linear map Λ given by, respectively, Eq. (2.49) and Eq. (2.51) can be expressed as (with $\alpha \leftrightarrow (k, l)$ and $\beta \leftrightarrow (k', l')$)

$$\Lambda_{\alpha\beta} = \Lambda_{kl, k'l'} \quad (2.54)$$

$$\Lambda'_{\alpha\beta} = \Lambda_{kk', ll'}. \quad (2.55)$$

In this specific case, the coefficient matrices in the two representations are then simply related by an index exchange; these are the quantum stochastic matrices introduced by Sudarshan fifty years ago [49, 50].

Finally, a linear map $\Lambda \in \mathcal{LL}(\mathbb{C}^N)$ is said to be an *hermiticity-preserving* map if it sends hermitian operators $\omega \in \mathcal{L}(\mathbb{C}^N)$ into hermitian operators, which can be equivalently expressed as

$$[\Lambda(\omega)]^{\dagger} = \Lambda(\omega^{\dagger}) \quad \forall \omega \in \mathcal{L}(\mathbb{C}^N). \quad (2.56)$$

Moreover, Λ is a positivity-preserving map, or simply a *positive map*, if it sends positive definite operators $\rho \in \mathcal{L}(\mathbb{C}^N)$ into positive definite operators. It is easy to see that the condition into Eq. (2.56) reflects into the representation of the linear map Λ given by Eqs. (2.50) and (2.51) with the following condition

$$\Lambda'_{\alpha\beta} = \Lambda_{\beta\alpha}^* \quad \forall \alpha, \beta = 1, \dots, N^2, \quad (2.57)$$

where z^* indicates the complex conjugate of the complex number z . That is, the associated matrix Λ' is hermitian, $(\Lambda')^\dagger = \Lambda'$. As will be discussed in the next paragraph, the matrix Λ' further enables to directly assess not the positivity of Λ , but the stronger condition consisting in complete positivity.

2.2.2 Kraus decomposition

In the previous paragraph, we introduced the space $\mathcal{LL}(\mathbb{C}^N)$ of linear maps on $\mathcal{L}(\mathbb{C}^N)$, providing two different ways in order to represent its elements. Indeed, we still have to specify which of these maps can properly describe transformations of quantum states. A linear map Λ on $\mathcal{L}(\mathbb{C}^N)$ is a well-defined transformation of the whole set of quantum states $\mathcal{S}(\mathbb{C}^N)$, see Eq. (2.4), if it is a trace preserving⁵ positive map. However, the transformations of quantum states are usually described by a class of linear maps satisfying a condition that is stronger than positivity, namely the *complete positivity*. A linear map

$$\begin{aligned} \Lambda : \mathcal{T}(\mathcal{H}) &\rightarrow \mathcal{T}(\mathcal{H}) \\ \omega &\rightarrow \Lambda(\omega) \end{aligned} \quad (2.58)$$

is completely positive if and only if $\Lambda \otimes \mathbb{1}_n$, defined as

$$\begin{aligned} \Lambda \otimes \mathbb{1}_n : \mathcal{T}(\mathcal{H} \otimes \mathbb{C}^n) &\rightarrow \mathcal{T}(\mathcal{H} \otimes \mathbb{C}^n) \\ \omega \otimes \sigma_n &\rightarrow \Lambda(\omega) \otimes \sigma_n, \end{aligned} \quad (2.59)$$

is positive for any $n \in \mathbb{N}$, with $\mathbb{1}_n$ identity operator on \mathbb{C}^n and $\sigma_n \in \mathcal{L}(\mathbb{C}^n)$. It can be shown [51] that for $\mathcal{H} = \mathbb{C}^N$ the positivity of $\Lambda \otimes \mathbb{1}_N$ is sufficient in order to guarantee the complete positivity of Λ . A simple example of a map which is positive but not completely positive is supplied by the transposition map. From a mathematical point of view, the relevance of complete positivity relies on the very simple and general representation provided by the well-known Kraus decomposition⁶, which does not have counterpart for positive maps: a linear map Λ on $\mathcal{L}(\mathbb{C}^N)$ is completely positive if and only if it can be written as

$$\Lambda(\omega) = \sum_{\alpha=1}^{N^2} \tau_\alpha \omega \tau_\alpha^\dagger, \quad (2.60)$$

with $\tau_\alpha \in \mathcal{L}(\mathbb{C}^N)$. The latter are usually called *Kraus operators*. Moreover, in the description of the dynamics of open quantum systems the role of complete positivity is strictly connected to the assumption of a product initial state between the system and the environment, as will be discussed

⁵Strictly speaking, Λ has only to preserve the trace of positive definite operators. But if a map is trace preserving on positive operators, then is it so for any operator $A \in \mathcal{L}(\mathbb{C}^N)$. This is shown by writing $A = A^a + iA^b$, with $A^a = (A^\dagger + A)/2$ and $A^b = i(A^\dagger - A)/2$ self-adjoint operators, then dividing both A^a and A^b into a positive and a negative part by means of the spectral decomposition and, finally, employing the linearity of the trace.

⁶We refer to the case of a finite-dimensional Hilbert space, treated by Choi in [52]. The theorem by Kraus [53] is more general since it applies to linear maps on the C^* -algebra $\mathcal{B}(\mathcal{H})$ of bounded linear operators on a possibly infinite-dimensional Hilbert space \mathcal{H} .

in the last paragraph of this section and in Chapter 5.

Here, we want to connect the Kraus decomposition with the general representations of linear maps introduced in the previous paragraph; as already said, it turns out that in this context the representation given by Eqs. (2.50) and (2.51) is the most convenient. In particular, consider the case in which the $N^2 \times N^2$ matrix Λ' with elements as in Eq. (2.51) is positive definite, i.e. hermitian and with positive eigenvalues $\{\lambda'_\alpha\}_{\alpha=1,\dots,N^2}$. Then, there is a unitary matrix U such that $\Lambda' = UD'U^\dagger$, where $D' = \text{diag}\{\lambda'_\alpha\}_{\alpha=1,\dots,N^2}$ and the N^2 columns of U are the N^2 -dimensional eigenvectors of Λ' , denoted as $\{C_\alpha\}_{\alpha=1,\dots,N^2}$, with components $C_\alpha^{(\beta)}$, $\beta = 1, \dots, N^2$. Let $\{\tilde{\sigma}_\alpha\}_{\alpha=1,\dots,N^2}$ be the basis in $\mathcal{L}(\mathbb{C}^N)$ given by

$$\tilde{\sigma}_\alpha = \sum_{\beta} U_{\beta\alpha} \sigma_\beta. \quad (2.61)$$

Thus, substituting Eq. (2.61) into Eq. (2.50) and exploiting the diagonalization of the matrix with entries $\Lambda'_{\alpha\beta}$, one can write the linear map $\Lambda \in \mathcal{LL}(\mathbb{C}^N)$ as in Eq. (2.60), with Kraus operators τ_α obtained from the eigenvalues and the eigenvectors of the coefficient matrix Λ' through

$$\tau_\alpha = \sqrt{\lambda'_\alpha} \tilde{\sigma}_\alpha = \sqrt{\lambda'_\alpha} \sum_{\beta} C_\alpha^{(\beta)} \sigma_\beta. \quad (2.62)$$

Then, the positive definiteness of the matrix Λ' implies that the linear map Λ is completely positive. The Kraus decomposition of the map Λ as in Eq. (2.60) is highly non-unique: for any family of operators $\{\tilde{\tau}_\alpha\}_{\alpha=1,\dots,N^2}$ defined through

$$\tilde{\tau}_\alpha = \sum_{\beta} W_{\alpha\beta} \tau_\beta, \quad (2.63)$$

with $W_{\alpha\beta}$ elements of a unitary matrix, one has $\sum_{\alpha} \tau_\alpha \omega \tau_\alpha^\dagger = \sum_{\alpha} \tilde{\tau}_\alpha \omega \tilde{\tau}_\alpha^\dagger$ for any $\omega \in \mathcal{L}(\mathbb{C}^N)$. Note that while

$$\langle \tau_\alpha, \tau_\beta \rangle = \delta_{\alpha\beta} \lambda_\alpha, \quad (2.64)$$

generally $\tilde{\tau}_\alpha$ and $\tilde{\tau}_\beta$, with $\alpha \neq \beta$, are not orthogonal. In fact, if the matrix of coefficients Λ' is not degenerate, the Kraus decomposition obtained from its diagonalization is the only one (up to phase choices for the Kraus operators) which satisfies the orthogonality relation in Eq. (2.64); for this reason it is called *canonical form* of the Kraus decomposition [54].

The Kraus decomposition characterizes completely positive maps, and then it is worth stressing that the positivity of the matrix of coefficients Λ' , which determines the linear map Λ through Eq. (2.50), does not simply correspond to positivity of the linear map Λ , but to the stronger condition given by complete positivity. This can be better understood as follows. Consider the maximally entangled state in $\mathbb{C}^N \otimes \mathbb{C}^N$, see Eq. (2.28), $|\phi\rangle_{ME} = 1/\sqrt{N} \sum_k |u_k\rangle \otimes |u_k\rangle$, with $\{|u_k\rangle\}_{k=1,\dots,N}$ orthonormal basis of \mathbb{C}^N . Then, one can write

$$|\phi\rangle_{ME} \langle \phi| = \frac{1}{N} \sum_{k,k'} |u_k\rangle \langle u_{k'}| \otimes |u_k\rangle \langle u_{k'}| = \frac{1}{N} \begin{pmatrix} e_{11} & e_{12} & \dots & e_{1n} \\ e_{21} & e_{22} & \dots & e_{2n} \\ \vdots & \vdots & \ddots & \vdots \\ e_{n1} & e_{n2} & \dots & e_{nn} \end{pmatrix}, \quad (2.65)$$

where we ordered the basis of $\mathbb{C}^N \otimes \mathbb{C}^N$ as $\{|u_1, u_1\rangle, |u_2, u_1\rangle, \dots, |u_N, u_1\rangle, |u_1, u_2\rangle, \dots, |u_N, u_N\rangle\}$, with the notation $|u_k, u_{k'}\rangle \equiv |u_k\rangle \otimes |u_{k'}\rangle$. The maximally entangled state is then proportional to the $N \times N$ block matrix with entries given by the $N \times N$ matrices $\{e_{kl}\}_{k,l=1\dots N}$ defined in Eq. (2.52), with 1 at the (k, l) component and 0 elsewhere. Let us now focus on the action of the linear operator $\Lambda \otimes \mathbb{1}_N$ on the maximally entangled state in Eq. (2.65): one has

$$N\Lambda \otimes \mathbb{1}_N(|\phi\rangle_{ME}\langle\phi|) = \sum_{k,k'} \Lambda(|u_k\rangle\langle u_{k'}|) \otimes |u_k\rangle\langle u_{k'}| = \begin{pmatrix} \Lambda(e_{11}) & \Lambda(e_{12}) & \dots & \Lambda(e_{1n}) \\ \Lambda(e_{21}) & \Lambda(e_{22}) & \dots & \Lambda(e_{2n}) \\ \vdots & \vdots & \ddots & \vdots \\ \Lambda(e_{n1}) & \Lambda(e_{n2}) & \dots & \Lambda(e_{nn}) \end{pmatrix}. \quad (2.66)$$

The matrix in Eq. (2.66) is called *Choi matrix* and it will be indicated in the following as Λ_{Choi} ; its elements with respect to the basis $\{|u_k, u_l\rangle\}_{k,l=1,\dots,N}$ then satisfy

$$\begin{aligned} \langle u_k, u_l | \Lambda_{\text{Choi}} | u_{k'}, u_{l'} \rangle &= N \langle u_k, u_l | \Lambda \otimes \mathbb{1}_N(|\phi\rangle_{ME}\langle\phi|) | u_{k'}, u_{l'} \rangle \\ &= \langle u_k | \Lambda(|u_l\rangle\langle u_{l'}|) | u_{k'} \rangle = \Lambda_{kk', ll'}, \end{aligned} \quad (2.67)$$

where in the last equality we used the notation introduced in Eq. (2.53). By comparing Eq. (2.55) and Eq.(2.67), one can conclude that the matrix elements of Λ' as in Eq. (2.51) with respect to the standard basis defined in Eq. (2.52) equal (up to a constant term) the matrix elements of the state $\Lambda \otimes \mathbb{1}_N(|\phi\rangle_{ME}\langle\phi|)$ with respect to the basis $\{|u_k, u_l\rangle\}_{k,l=1,\dots,N}$. Note that this implies that the positive definiteness of Λ' is not only a sufficient, but also a necessary condition for the complete positivity of Λ ⁷. Finally, this analysis elucidates how Eq. (2.66) establishes an isomorphism, the Choi-Jamiołkowski isomorphism [55, 52], between the completely positive linear maps acting on $\mathcal{L}(\mathbb{C}^N)$, represented by a positive matrix Λ' , and the states on $\mathcal{L}(\mathbb{C}^N \otimes \mathbb{C}^N)$.

Before concluding this paragraph, let us make two more remarks. First, if one asks that the completely positive linear map Λ with Kraus decomposition as in Eq. (2.60) is trace preserving, then the Kraus operators have to fulfill the relation

$$\sum_{\alpha=1}^{N^2} \tau_\alpha^\dagger \tau_\alpha = \mathbb{1}_N. \quad (2.68)$$

Moreover, the previous analysis can be generalized in a straightforward way to linear maps Λ which are hermiticity-preserving. In fact, because of the hermiticity of the matrix Λ' , see Eq. (2.57), and proceeding as before, one can always write an hermiticity-preserving map as [56]

$$\Lambda(\omega) = \sum_{\alpha=1}^{N^2} \epsilon_\alpha \tau_\alpha \omega \tau_\alpha^\dagger \quad \omega \in \mathcal{L}(\mathbb{C}^N), \quad (2.69)$$

where τ_α is given by Eq.(2.62), with λ'_α replaced by $|\lambda'_\alpha|$, and $\epsilon_\alpha = \pm 1$ is the sign of λ'_α .

⁷Indeed, this is the case for every orthonormal basis in $\mathcal{L}(\mathbb{C}^N)$ used to expand the linear map Λ in Eq.(2.50): the matrices of coefficients Λ' and $\bar{\Lambda}'$ with respect to two different orthonormal bases are simply related by $\bar{\Lambda}' = V\Lambda'V^\dagger$, with V unitary matrix.

2.2.3 Damping bases

Consider now a completely positive linear map Λ acting on $\mathcal{L}(\mathbb{C}^N)$. We have seen how complete positivity implies that the matrix Λ' associated with the representation of Λ given by Eqs. (2.50) and (2.51) is positive definite. Indeed, this does not mean that the matrix Λ corresponding to Eqs. (2.41) and (2.42) has to be positive definite, as well. Thus, in general, Λ is not a positive-definite operator on the Hilbert space $\mathcal{L}(\mathbb{C}^N)$, i.e., see Eq. (2.38), there exists some $\omega \in \mathcal{L}(\mathbb{C}^N)$ such that $\langle \omega, \Lambda(\omega) \rangle$ is not a real positive number. However, it may still happen that the matrix Λ can be diagonalized. Its possible diagonalization leads to the introduction of the *damping bases* [57]. These were introduced in a slightly different context and referred to Lindblad structures, see Sec. (3.3.1). It is worth stressing by now that the characterization of linear maps we are presenting in this section will be useful also in dealing with maps that do not describe transformations of quantum states, such as the generators appearing in quantum master equations.

Consider then a diagonalizable linear map Λ represented by Λ , i.e. there is a matrix B such that $\Lambda = BDB^{-1}$, with $D = \text{diag} \{ \lambda_\alpha \}_{\alpha=1, \dots, N^2}$. Substituting this relation into Eq. (2.41), one gets the expansion

$$\Lambda(\omega) = \sum_{\alpha} \lambda_{\alpha} \text{Tr}[\varsigma_{\alpha}^{\dagger} \omega] \varpi_{\alpha} \quad \omega \in \mathcal{L}(\mathbb{C}^N), \quad (2.70)$$

with

$$\begin{aligned} \varpi_{\alpha} &= \sum_{\beta} B_{\beta\alpha} \sigma_{\beta} \\ \varsigma_{\alpha}^{\dagger} &= \sum_{\beta} (B^{-1})_{\alpha\beta} \sigma_{\beta}^{\dagger}. \end{aligned} \quad (2.71)$$

From Eqs. (2.40) and (2.71), one immediately has that the two families of operators $\{\varpi_{\alpha}\}_{\alpha=1, \dots, N^2}$ and $\{\varsigma_{\alpha}\}_{\alpha=1, \dots, N^2}$ satisfy

$$\langle \varsigma_{\alpha}, \varpi_{\beta} \rangle = \text{Tr}[\varsigma_{\alpha}^{\dagger} \varpi_{\beta}] = \delta_{\alpha\beta}. \quad (2.72)$$

This can be read as a duality relation between the basis $\{\varpi_{\alpha}\}_{\alpha=1, \dots, N^2}$ and the basis $\{\varsigma_{\alpha}\}_{\alpha=1, \dots, N^2}$, that is defined in the dual space. In this sense, these two families of operators are often referred to as bi-orthogonal (or damping [57]) bases. Indeed, since we are here considering the finite dimensional case, they are both defined in the Hilbert space $\mathcal{L}(\mathbb{C}^N)$. In any case, the connection between damping bases and duality relation can be shown by taking into account the map Λ^* dual to Λ , see Eq. (2.39) and (2.37). Since the linear map Λ is given by Eq. (2.41), its dual map can be written as

$$\Lambda^*(\omega) = \sum_{\alpha\beta} \Lambda_{\alpha\beta}^* \text{Tr}[\sigma_{\alpha}^{\dagger} \omega] \sigma_{\beta} \quad \omega \in \mathcal{L}(\mathbb{C}^N), \quad (2.73)$$

where $\Lambda_{\alpha\beta}^*$ is the complex conjugate of $\Lambda_{\alpha\beta}$. Passing to the damping bases, one has

$$\Lambda^*(\omega) = \sum_{\alpha} \lambda_{\alpha}^* \text{Tr}[\varpi_{\alpha}^{\dagger} \omega] \varsigma_{\alpha} \quad \omega \in \mathcal{L}(\mathbb{C}^N). \quad (2.74)$$

From Eqs. (2.70) and (2.74) one can then see that the operators $\{\varpi_{\alpha}\}_{\alpha=1, \dots, N^2}$ and $\{\varsigma_{\alpha}\}_{\alpha=1, \dots, N^2}$ are the eigenvectors, respectively, of the linear map Λ and of its dual Λ^* with respect to complex

conjugates eigenvalues, i.e.

$$\Lambda(\varpi_\alpha) = \lambda_\alpha \varpi_\alpha, \quad \Lambda^*(\varsigma_\alpha) = \lambda_\alpha^* \varsigma_\alpha; \quad \alpha = 1, \dots, N^2. \quad (2.75)$$

One can see [48] that for the special case with $B = U$, where U is a unitary matrix, the linear map Λ is normal, in the sense that $\Lambda\Lambda^* = \Lambda^*\Lambda$.

Finally, let us note that any $\omega \in \mathcal{L}(\mathbb{C}^N)$ can be expanded on the damping bases, as

$$\begin{aligned} \omega &= \sum_{\alpha} c_{\alpha} \varpi_{\alpha}, \\ c_{\alpha} &= \langle \varsigma_{\alpha}, \omega \rangle = \text{Tr}[\varsigma_{\alpha}^{\dagger} \omega], \end{aligned} \quad (2.76)$$

the coefficients of the expansion being obtained by means of the dual basis.

2.2.4 An example: completely positive maps on the Bloch sphere

In order to give an explicit example of what has been presented so far, let us consider the simplest quantum system, namely the two-level system associated with the Hilbert space \mathbb{C}^2 .

An orthonormal basis on the Banach space $\mathcal{L}(\mathbb{C}^2)$ of linear operators on \mathbb{C}^2 is provided by $\{\mathbb{1}/\sqrt{2}, \sigma_k/\sqrt{2}\}_{k=x,y,z}$, where

$$\sigma_x = \begin{pmatrix} 0 & 1 \\ 1 & 0 \end{pmatrix} \quad \sigma_y = \begin{pmatrix} 0 & -i \\ i & 0 \end{pmatrix} \quad \sigma_z = \begin{pmatrix} 1 & 0 \\ 0 & -1 \end{pmatrix} \quad (2.77)$$

denote the usual Pauli matrices. The set of 2×2 positive definite matrices with unit trace represents the set $\mathcal{S}(\mathbb{C}^2)$ of physical states. Any such matrix can be written as

$$\rho(\mathbf{v}) = \frac{1}{2} (\mathbb{1} + \mathbf{v} \cdot \boldsymbol{\sigma}), \quad (2.78)$$

where $\boldsymbol{\sigma}$ is the vector with components $\sigma_x, \sigma_y, \sigma_z$ and \mathbf{v} is a 3-dimensional real vector, such that $|\mathbf{v}| \leq 1$: $\mathcal{S}(\mathbb{C}^2)$ can be identified with the unit ball in \mathbb{R}^3 . The surface of this ball, known as *Bloch sphere*, represents the set of pure states of the system.

Any linear map $\Lambda \in \mathcal{LL}(\mathbb{C}^2)$ can be represented by 4×4 complex matrices, according to the representations introduced in Sec. (2.2.1). In particular, it is easy to see that if Λ is trace and hermiticity preserving, then the matrix corresponding to Eqs. (2.48) and (2.49) has to be of the form

$$\Lambda = \begin{pmatrix} 1 & \mathbf{0} \\ \mathbf{b} & B \end{pmatrix}, \quad (2.79)$$

with $\mathbf{0}, \mathbf{b} \in \mathbb{R}^3$ and B a 3×3 real matrix. Thus, the action of a trace preserving linear map Λ on a statistical operator $\rho(\mathbf{v})$ can be expressed as

$$\Lambda(\rho(\mathbf{v})) = \frac{1}{2} [\mathbb{1} + (\mathbf{b} + B\mathbf{v}) \cdot \boldsymbol{\sigma}], \quad (2.80)$$

that is Λ modifies the Bloch sphere according to

$$\mathbf{v} \rightarrow \mathbf{b} + B\mathbf{v}. \quad (2.81)$$

Using the singular value decomposition on the matrix B , any linear map with matrix representation as in Eq. (2.79) can be written as [58]

$$\Lambda(\omega) = U \left[\bar{\Lambda}(V\omega V^\dagger) \right] U^\dagger, \quad (2.82)$$

where $\bar{\Lambda}$ is the linear map corresponding to

$$\bar{\Lambda} = \begin{pmatrix} 1 & 0 & 0 & 0 \\ b_x & B_x & 0 & 0 \\ b_y & 0 & B_y & 0 \\ b_z & 0 & 0 & B_z \end{pmatrix}, \quad (2.83)$$

while U and V are unitary operators, which describe a change of basis in \mathbb{C}^2 or, equivalently, a rotation acting on the Pauli matrices. Indeed, b_k describes a translation along the k -direction, and B_k accounts for a deformation and, eventually, a reflection in the k -direction.

In order to preserve the positivity, a linear map has to send the Bloch sphere into the unit ball. Given $\bar{\Lambda}$ as in Eq. (2.83) this is accomplished only if $|b_k| + |B_k| \leq 1$. On the other hand, the characterization of completely positive maps on $\mathcal{L}(\mathbb{C}^2)$ by means of their action on the Bloch sphere is more complex [59] and, ultimately, one has to check the eigenvalues of the Choi matrix associated with Λ , see Eq. (2.66). Nevertheless, let us note that Λ in Eq. (2.82) is completely positive if and only if $\bar{\Lambda}$ is, so that the question of complete positivity can be faced by focusing on maps as in Eq. (2.83) [59]. To highlight the difference between the positivity and the complete positivity condition, consider the linear map Λ defined as

$$\Lambda = \begin{pmatrix} 1 & 0 & 0 & 0 \\ 0 & B & 0 & 0 \\ 0 & 0 & B & 0 \\ 0 & 0 & 0 & B_z \end{pmatrix}, \quad (2.84)$$

which describes a deformation of the Bloch sphere homogeneous in the x - y plane. Indeed, this map is positive if and only if $|B|, |B_z| \leq 1$. The corresponding Choi matrix is given by

$$\Lambda_{\text{Choi}} = \begin{pmatrix} (1+B_z)/2 & 0 & 0 & B \\ 0 & (1-B_z)/2 & 0 & 0 \\ 0 & 0 & (1-B_z)/2 & 0 \\ B & 0 & 0 & (1+B_z)/2 \end{pmatrix}, \quad (2.85)$$

so that Λ is completely positive if and only if the following conditions are satisfied:

$$|B_z| \leq 1 \quad |B| \leq \frac{B_z + 1}{2}, \quad (2.86)$$

so that if $|B_z| \leq 1$, any B such that $(B_z + 1)/2 \leq |B| \leq 1$ defines a positive, but not completely positive map through Eq. (2.84).

2.2.5 Completely positive maps and reduced dynamics of open quantum systems

To conclude this chapter, we show how the formalism of linear maps on operator spaces introduced in the previous paragraphs applies to the description of the dynamics of open quantum systems.

An open quantum system is a quantum system interacting with another system, the environment. As said in section (2.1.3), the system and the environment are the two subsystems of a composite total system. It is usually assumed that the latter is closed, thus evolving through a unitary dynamics. However, the complete description of the entire dynamics is often too complicated to be performed explicitly, even by means of numerical techniques. Moreover, from the experimental point of view, one can generally control only on a small part of the full system. In any case, even if one could characterize the whole set of degrees of freedom, he would get an intractable amount of information, most of which useless for a reasonable description of the system. One is therefore driven to look for a simpler description in terms of a restrict set of relevant dynamical variables, performing an average over the remaining degrees of freedom. Indeed, the border between system and environment is not assigned a-priori, but ultimately depends on the physical quantities actually measurable in the experiment, see also Chapter 6.

Let \mathcal{H}_S be the Hilbert space associated with the open system and \mathcal{H}_E the Hilbert space associated with the environment. The open system is often referred to as *reduced system*. We use the subscript S for operators on \mathcal{H}_S and the subscript E for operators on \mathcal{H}_E . Since one is only interested in observables related to the open system, it is convenient to introduce the statistical operator associated with the state of the open system, or *reduced state*, see Eq. (2.31):

$$\rho_S = \text{tr}_E[\rho_{SE}], \quad (2.87)$$

where tr_E is the partial trace over \mathcal{H}_E and represents an average over the environmental degrees of freedom. The total system evolves through a unitary dynamics, which is fixed by the total Hamiltonian

$$H(t) = H_S(t) \otimes \mathbb{1}_E + \mathbb{1}_S \otimes H_E(t) + H_I(t), \quad (2.88)$$

where $H_S(t)$ is the self-Hamiltonian of the open system, $H_E(t)$ is the self-Hamiltonian of the environment and $H_I(t)$ is the Hamiltonian describing the interaction between the system and the environment. The total Hamiltonian uniquely determines the unitary evolution operator

$$U(t, t_0) = T_{\leftarrow} \exp \left[-i \int_{t_0}^t ds H(s) \right], \quad (2.89)$$

where t_0 is the initial time and T_{\leftarrow} denotes the chronological time-ordering operator, which orders product of time-dependent operators such that their time-arguments increase from right to left. The state of the total system at a time t , $\rho_{SE}(t)$, is obtained from the total initial state through the unitary evolution

$$\rho_{SE}(t) = U(t, t_0) \rho_{SE}(t_0) U^\dagger(t, t_0). \quad (2.90)$$

This represents a very special case of the completely positive trace preserving transformation maps presented in the previous paragraphs, see Eq. (2.60) and Eq. (2.68).

By taking the partial trace over the degrees of freedom of the environment in Eq. (2.90), the total initial state $\rho_{SE}(t_0)$ is mapped to the state of the open system at a time t ,

$$\rho_S(t) = \text{tr}_E[U(t, t_0)\rho_{SE}(t_0)U^\dagger(t, t_0)]. \quad (2.91)$$

In this way, one establishes a family of evolution maps from the set of states of the total system to the set of states of the open system, according to

$$\rho_{SE}(t_0) \mapsto \rho_S(t) = \Upsilon(t, t_0)\rho_{SE}(t_0) = \text{tr}_E[U(t, t_0)\rho_{SE}(t_0)U^\dagger(t, t_0)] \quad (2.92)$$

Note that these are linear, trace preserving and completely positive maps⁸, since the partial trace is completely positive [3] and the composition of two completely positive maps is completely positive. However, it is clear that in order to give a self-consistent description of the dynamics of the open quantum system one has to introduce a map on the set of states of the open system, associating to any reduced initial state $\rho_S(t_0)$ the corresponding state at a time t , $\rho_S(t)$. If the open system and the environment are initially in a product state

$$\rho_{SE}(t_0) = \rho_S(t_0) \otimes \rho_E(t_0) \quad (2.93)$$

with a fixed environmental state $\rho_E(t_0)$, Eq. (2.91) allows to define a linear map $\Lambda(t, t_0)$ from the state space of the open system into itself,

$$\rho_S(t_0) \mapsto \rho_S(t) = \Lambda(t, t_0)\rho_S(t_0) = \text{tr}_E \left[U(t, t_0) \rho_S(t_0) \otimes \rho_E(t_0) U^\dagger(t, t_0) \right]. \quad (2.94)$$

By means of the spectral decomposition of the fixed environmental state $\rho_E(t_0)$, one can show that the linear map $\Lambda(t, t_0)$ is completely positive:

$$\begin{aligned} \rho_S(t) &= \text{Tr}_E[U(t, t_0)\rho_S(t_0) \otimes \rho_E(t_0)U^\dagger(t, t_0)] \\ &= \sum_k \langle u_k | U(t, t_0)\rho_S(t_0) \otimes \left(\sum_{k'} p_{k'} |v_{k'}\rangle \langle v_{k'}| \right) U^\dagger(t, t_0) |u_k\rangle \\ &= \sum_{kk'} \langle u_k | \sqrt{p_{k'}} U(t, t_0) |v_{k'}\rangle \rho_S(t_0) \langle v_{k'} | \sqrt{p_{k'}} U^\dagger(t, t_0) |u_k\rangle \\ &= \sum_{kk'} M_{kk'}(t, t_0) \rho_S(t_0) M_{kk'}^\dagger(t, t_0). \end{aligned} \quad (2.95)$$

Indeed, $\Lambda(t, t_0)$ can be expanded via linearity to the whole set of trace class operators [50], so that Eq. (2.95) represents its Kraus decomposition, see Eq. (2.60), with Kraus operators given by

$$M_{kk'}(t, t_0) := \sqrt{p_{k'}} \langle u_k | U(t, t_0) |v_{k'}\rangle. \quad (2.96)$$

The trace preserving condition in Eq. (2.68) is satisfied as a consequence of the unitarity of $U(t, t_0)$. Thus, if the total initial state is a product state, the evolution of the open system can

⁸Indeed, from Eqs. (2.58) and (2.59) one can easily generalize the definition of complete positivity to linear maps defined from $\mathcal{T}(\mathcal{H}_{SE})$ to $\mathcal{T}(\mathcal{H}_S)$

always be characterized by a one-parameter family of completely positive trace preserving linear (CPT) maps $\{\Lambda(t, t_0)\}_{t \geq t_0}$.⁹ The latter are usually called *reduced dynamical maps*. As will be discussed in more details in Chapter 5, in the presence of initial correlations between the system and the environment, the very existence of reduced dynamical maps becomes problematic. On the other hand, every CPT map can be seen as a reduced dynamical map with a product total initial state. Consider the finite dimensional Hilbert space $\mathcal{H} = \mathbb{C}^N$: assigned a completely positive trace preserving linear map Λ on $\mathcal{L}(\mathbb{C}^N)$, there exist an Hilbert space \mathcal{K} , a pure state $|\psi_0\rangle$ in \mathcal{K} and a unitary map $U : \mathcal{H} \otimes \mathcal{K} \rightarrow \mathcal{H} \otimes \mathcal{K}$ such that

$$\Lambda(\omega) = \text{tr}_{\mathcal{K}}[U (\omega \otimes |\psi_0\rangle\langle\psi_0|) U^\dagger]. \quad (2.97)$$

The Hilbert space \mathcal{K} can be chosen such that its dimension is smaller or equal to the square dimension of \mathcal{H} . This is a corollary of the Stinespring's dilation theorem [60], which applies more generally to completely positive maps between C^* -algebras.

The reduced dynamics that can be exactly derived through Eq. (2.94), although very useful as reference models, are actually quite exceptional. One generally deals with a reduced dynamics that is obtained after physically motivated approximations. Then, complete positivity is no longer guaranteed, but it has to be checked explicitly. Thus, it is worth stressing that, given a family of CPT dynamical maps, the construction in Eq. (2.97) concerns the single dynamical maps, in general without providing unique environment and one-parameter group of unitary operators on the total Hilbert space, from which the whole family of maps can be obtained in an exact way.

⁹This family of dynamical maps is only defined for $t \geq t_0$ since the dynamics of an open system is irreversible. More precisely, a linear, trace preserving and completely positive map can be inverted by another linear, trace preserving and completely positive map if and only if it is unitary [46].

Chapter 3

Master equations

In the previous chapter, we have seen that the evolution of open quantum systems can be characterized through a one-parameter family of completely positive trace preserving linear (CPT) maps. However, in concrete physical settings one is often faced with equations of motion rather than with evolution maps and the latter are usually obtained by solving the former.

Thus, we now focus on the description of the dynamics of open quantum systems via proper equations of motion for the reduced statistical operator, that is, quantum *master equations* [1]. It is worth stressing by now that, on the one hand, it is not fully clear which is the most general operator structure of the master equations which do provide a well-defined time evolution and, in particular, preserve complete positivity. On the other hand, one would like to link, in a possibly intuitive way, operator structures giving a sensible dynamical evolution with microscopic information on the physics of the system of interest. An important case in which both these approaches, phenomenological and microscopic, are well understood and successfully applied is given by semigroup dynamics [14, 15].

In the first section, we focus on to what extent every open-system dynamics can be described by both local and non-local in time master equations. We first show that time-local and integrodifferential equations of motion can be derived from the unitary time evolution of the total system by means of projection operator techniques. Time-local master equations are not necessarily well defined at every time, but they can present isolated singularities. Then, we describe the connections between a generic family of dynamical maps and the corresponding local and non-local master equations, also by means of the representations introduced in Sec. (2.2). Finally, we provide the general structure of time-local as well as integrodifferential master equations which guarantee trace and hermiticity preservation.

In the second section, we apply the analysis presented in the first section to a concrete physical model [28]. Namely, we obtain the exact time-local and integrodifferential equations of motion of a two-level system coupled to a bosonic reservoir consisting first of a single mode of the quantized electromagnetic field initially in a thermal state, and then in a collection of quantum harmonic oscillators initially in the vacuum state. Furthermore, we consider the more general and not exactly solvable case in which the collection of harmonic oscillators is initially in a thermal state. We apply a perturbation expansion to the time-local master equation derived via projection operator

techniques and we show, in particular, that the operator structures of local and non-local master equations can strongly differ, also depending on the state of the bath.

In the last section, we deal with the problem of identifying those master equations which preserve the complete positivity of the evolution. We first focus on quantum dynamical semigroups. The full characterization of the structure of their generators provides a necessary and sufficient condition for master equations to be well-defined on an entire class of dynamics, that are significant both from a mathematical and a physical point of view. The latter aspect is connected with the concept of Markovianity in the dynamics of open quantum systems, which will be the main subject of the next chapter. We further present two natural generalizations of quantum semigroups, one that is typically obtained from time-local master equations, the other from integrodifferential master equations. Furthermore, we show by means of a simple example some of the problems that arise when trying to characterize in full generality those master equations which guarantee a completely positive evolution.

3.1 Local versus non-local description of reduced dynamics

3.1.1 Integrodifferential and time-local equations of motion from projection operator techniques

Now, we want to derive a closed equation of motion for the dynamics of an open system, starting from the unitary time evolution of the corresponding total system and exploiting projection operator techniques [1]. By differentiating the evolution map in Eq. (2.90) with respect to time, one gets the Liouville-von Neumann master equation for the statistical operator of the total system, that in interaction picture reads

$$\frac{d}{dt}\rho_{SE}(t) = -i[H_I(t), \rho_{SE}(t)] \equiv L(t)\rho_{SE}(t), \quad (3.1)$$

where, assuming for simplicity a time independent Hamiltonian H and defining $H_0 = H_S \otimes \mathbb{1} + \mathbb{1} \otimes H_E$, the Hamiltonian in interaction picture is $H_I(t) = \exp(iH_0t)H_I \exp(-iH_0t)$. The basic idea behind the projection operator techniques is to regard the trace over the degrees of freedom of the environment as a formal projection

$$\rho_{SE} \mapsto P\rho_{SE} = \text{tr}_E[\rho_{SE}] \otimes \rho_E \equiv \rho_S \otimes \rho_E, \quad (3.2)$$

with ρ_E fixed environmental state. The state $P\rho_{SE}$ is called *relevant part* of the total state, since it allows to reconstruct the open system dynamics, as one can see from the relation

$$\rho_S = \text{tr}_E[P\rho_{SE}]. \quad (3.3)$$

On the same way, one can introduce a further map Q defined as

$$Q\rho_{SE} = \rho_{SE} - P\rho_{SE}. \quad (3.4)$$

Note that P and Q are a pair of complementary projectors on the state space $\mathcal{S}(\mathcal{H})$ of the total Hilbert space $\mathcal{H} = \mathcal{H}_S \otimes \mathcal{H}_E$, since they satisfy $P+Q = \mathbb{1}$, $P^2 = P$, $Q^2 = Q$ and $PQ = QP = 0$. From Eq. (3.3), it is clear that, by deriving a closed equation of motion for the relevant part $P\rho_{SE}(t)$, one equivalently gets a closed equation of motion for the reduced state $\rho_S(t)$. Applying the two projectors P and Q to Eq. (3.1), one has

$$\begin{aligned} \frac{d}{dt}P\rho_{SE}(t) &= P\frac{d}{dt}\rho_{SE}(t) = PL(t)\rho_{SE}(t) = PL(t)P\rho_{SE}(t) + PL(t)Q\rho_{SE}(t), \\ \frac{d}{dt}Q\rho_{SE}(t) &= Q\frac{d}{dt}\rho_{SE}(t) = QL(t)\rho_{SE}(t) = QL(t)P\rho_{SE}(t) + QL(t)Q\rho_{SE}(t), \end{aligned} \quad (3.5)$$

where we used $P+Q = \mathbb{1}$ to derive the last equalities. The formal solution of the second equation for a total initial state $\rho_{SE}(t_0)$ is given by

$$Q\rho_{SE}(t) = D(t, t_0)Q\rho_{SE}(t_0) + \int_{t_0}^t ds D(t, s)QL(s)P\rho_{SE}(s), \quad (3.6)$$

where we introduced

$$D(t, s) \equiv \mathbb{T}_{\leftarrow} \exp \left[\int_s^t ds' QL(s') \right]. \quad (3.7)$$

Inserting Eq. (3.6) into the equation of motion for the relevant part of the total state, the following equation, known as Nakajima-Zwanzig equation [61, 62], is obtained:

$$\frac{d}{dt}P\rho_{SE}(t) = PL(t)D(t, t_0)Q\rho_{SE}(t_0) + PL(t)P\rho_{SE}(t) + \int_{t_0}^t ds PL(t)D(t, s)QL(s)P\rho_{SE}(s). \quad (3.8)$$

We emphasize that Eq. (3.8) has been derived in an exact way from the total unitary evolution and it holds for any total initial state. However, in the following we will consider product initial states $\rho_{SE}(t_0) = \rho_S(t_0) \otimes \rho_E$, so that the first term at the right hand side of Eq. (3.8) vanishes. Furthermore, one usually has that $PL(t)P = 0$ ¹ and then the Nakajima-Zwanzig equation reduces to

$$\frac{d}{dt}P\rho_{SE}(t) = \int_{t_0}^t ds \mathcal{K}_{NZ}(t, s)P\rho_{SE}(s), \quad (3.9)$$

with

$$\mathcal{K}_{NZ}(t, s) = PL(t)D(t, s)QL(s)P. \quad (3.10)$$

The right hand side of Eq. (3.9) consists in an integral over the past history of the system in the time interval $[t_0, t]$ and then it describes the memory effects on the reduced dynamics due to the interaction with the environment. The concept of memory effect plays a basic role in the definition of Markovianity, as will be widely discussed. The term $\mathcal{K}_{NZ}(t, s)$ is thus called *memory kernel*. In the following we will focus on time homogeneous kernel, i.e. such that $\mathcal{K}(t, s) = \mathcal{K}(t-s)$, which is the case for a stationary state ρ_E .

¹In any case, given a stationary ρ_E , one can always define a new interaction Hamiltonian with a shifted origin of the energy such that this relation holds [63].

The same techniques lead to time-local equations of motion for the relevant part of the dynamics. This is achieved by introducing a backward propagator (T_{\rightarrow} indicates the anti-chronological time-ordering)

$$G(t, s) = T_{\rightarrow} \exp \left[- \int_s^t ds' L(s') \right], \quad (3.11)$$

such that $\rho_{SE}(s) = G(t, s)\rho_{SE}(t)$. Inserting $\rho_{SE}(s) = G(t, s)(P + Q)\rho_{SE}(t)$ in Eq. (3.6) and defining

$$\Sigma(t) = \int_{t_0}^t ds D(t, s) Q L(s) P G(t, s), \quad (3.12)$$

one gets

$$Q\rho_{SE}(t) = [1 - \Sigma(t)]^{-1} \Sigma(t) P \rho_{SE}(t) + [1 - \Sigma(t)]^{-1} D(t, t_0) Q \rho_{SE}(t_0), \quad (3.13)$$

so that the first of Eq. (3.5) gives the time-convolutionless equation of motion [64, 65, 66, 67]

$$\frac{d}{dt} P \rho_{SE}(t) = \mathcal{K}_{TCL}(t) P \rho_{SE}(t) + \mathcal{I}(t) Q \rho_{SE}(t_0), \quad (3.14)$$

where we introduced *the time-local generator*

$$\mathcal{K}_{TCL}(t) = P L(t) [1 - \Sigma(t)]^{-1} P \quad (3.15)$$

and the inhomogeneous term

$$\mathcal{I}(t) = P L(t) [1 - \Sigma(t)]^{-1} D(t, t_0) Q, \quad (3.16)$$

which vanishes for a product initial state. The existence of the inverse map $[1 - \Sigma(t)]^{-1}$ is not always guaranteed, so that Eq. (3.14) is not necessarily well-defined for any $t \geq t_0$. Contrary to the integrodifferential equation in Eq. (3.8), the time-convolutionless equation cannot be generally obtained from the full unitary dynamics by projection operator techniques for every time $t \geq t_0$. Nevertheless, we will see in Sec. (3.2.4) how the inverse map does always exist for small values of $t - t_0$ and for small values of the coupling constant.

3.1.2 From linear maps to master equations

By means of projection operator techniques one can thus always derive master equations for the reduced statistical operator which are in integrodifferential form, the *Nakajima-Zwanzig master equations*²

$$\frac{d}{dt} \rho_S(t) = \int_{t_0}^t d\tau K_{NZ}(t - \tau) \rho_S(\tau), \quad (3.17)$$

²For the sake of clarity, we emphasize that in the following we will refer to this and the next equation to indicate *generic* integrodifferential and time-local master equations, respectively, not necessarily obtained by projection operator techniques, neither necessarily equivalent to the full unitary evolution. We have employed the notation \mathcal{K}_{TCL} for a time-local generator acting on the total system and obtained by projection operator techniques, while we use K_{TCL} for a generic time-local generator acting on the reduced system and \mathcal{K}_{TCL} for the matrix associated with its representation given by Eqs. (2.41) and (2.42), see Sec. (2.2.1). Fully analogous notations are used for the memory kernel.

or in time-local form, the *time-convolutionless master equations*

$$\frac{d}{dt}\rho_S(t) = K_{\text{TCL}}(t)\rho_S(t). \quad (3.18)$$

Indeed, this can be accomplished simply by taking the partial trace in, respectively, Eq. (3.9) and Eq. (3.14) and using $P\rho_{SE}(t) = \rho_S(t) \otimes \rho_E$. For simplicity, from now on we will set $t_0 = 0$ and, except if otherwise stated, we will omit the subscript S , so that the reduced statistical operator at a time t will be indicated as $\rho(t)$. Both Eq. (3.9) and (3.14) are exact and then they are as difficult to solve as the initial Liouville-von Neumann master equation. Therefore, perturbation expansions are usually employed in order to get a description of the reduced dynamics which can be explicitly accessed, analytically as well as numerically. An example for the time-local master equation of a two-level system will be given in Sec. (3.2.4). Moreover, the dynamics of open quantum systems is often studied through equations of motion, being local as well as non-local in time, that are not obtained from the full unitary evolution, but that are introduced on the basis of phenomenological ansatz in order to properly describe some observed phenomenon. In this paragraph, we emphasize that also in these situations the local and the non-local description of reduced dynamics are actually equivalent, in the sense that the same dynamics can be described by both a time-convolutionless and an integrodifferential master equation. In fact, we connect a generic one-parameter family of linear maps describing an open system evolution to a local as well as to a non-local master equation: indeed, different forms of equations might admit the very same solutions.

Consider a one-parameter family of reduced dynamical maps $\{\Lambda(t, 0)\}_{t \geq 0}$, where every $\Lambda(t, 0)$ is a completely positive trace preserving linear map defined on the whole set $\mathcal{L}(\mathbb{C}^N)$ of linear operators on \mathbb{C}^N . Indeed, the physical meaning of these maps as representatives of transformations of quantum systems is well established on the set $\mathcal{S}(\mathbb{C}^N)$ of physical states. However, since there are sets of statistical operators spanning $\mathcal{L}(\mathbb{C}^N)$, a linear map on $\mathcal{S}(\mathbb{C}^N)$ uniquely defines a linear map on $\mathcal{L}(\mathbb{C}^N)$. Under the hypotheses that $\Lambda(t, 0)$ can be derived with respect to time³ and that the inverse linear map $\Lambda^{-1}(t, 0)$ exists, it is straightforward to see that a time-local equation as in Eq. (3.18) is satisfied upon identifying

$$K_{\text{TCL}}(t) = \frac{d\Lambda(t, 0)}{dt} \Lambda^{-1}(t, 0). \quad (3.19)$$

It is worth stressing that, contrary to the reduced dynamical map $\Lambda(t, 0)$, the inverse map $\Lambda^{-1}(t, 0)$ is not completely positive, unless $\Lambda(t, 0)$ is unitary. In any case, the existence of a linear map $\Lambda^{-1}(t, 0)$ such that $\Lambda(t, 0)\Lambda^{-1}(t, 0) = \mathbb{1}$ is indeed not a priori guaranteed. As a consequence, it may well happen that at some times $t \in \mathbb{R}^+$ a time-local generator cannot be defined or, even, there is an infinity of generators corresponding to the same evolution [56]. However, apart from these critical points, the reduced dynamics can be safely characterized with a time-local master equation.

³Given a normed space X and a function $f : \mathbb{R} \rightarrow X$, one says that f can be derived in $\bar{t} \in \mathbb{R}$ if there is an element $x \in X$ such that the following implication holds: $\{h_n\}, h_n \in \mathbb{R}, h_n \neq 0 \forall n, |h_n| \rightarrow 0 \Rightarrow \|\frac{f(\bar{t}+h_n)-f(\bar{t})}{h_n} - x\| \rightarrow 0$, and x is the derivative of f in \bar{t} .

On a similar footing, by exploiting the Laplace transform, we can derive a master equation in integrodifferential form as in Eq. (3.17). We recall that the Laplace transform $\hat{v}(u)$ of the function or map $v(t)$ is defined as

$$\hat{v}(u) = \int_0^\infty dt v(t) e^{-ut}. \quad (3.20)$$

Since $\widehat{dv}/dt = u\hat{v}(u) - v(0)$ and the Laplace transform of the convolution between $v(t)$ and $w(t)$ is given by the product $\hat{v}(u)\hat{w}(u)$, from Eq. (3.17) one has

$$u\hat{\rho}(u) - \rho(0) = \widehat{K}_{\text{NZ}}(u)\hat{\rho}(u). \quad (3.21)$$

Then, since $\hat{\rho}(u) = \widehat{\Lambda}(u)\rho(0)$, we come to

$$\widehat{K}_{\text{NZ}}(u) = u\mathbb{1} - \widehat{\Lambda}^{-1}(u). \quad (3.22)$$

This relation is sometimes equivalently written as [68], see also Sec. (6.1.4),

$$\widehat{K}_{\text{NZ}}(u) = \frac{u\widehat{G}(u)}{1 + \widehat{G}(u)}, \quad (3.23)$$

where $\Lambda(t, 0) = \mathbb{1} + \int_0^t ds G(s)$, so that $u\widehat{\Lambda}(u) - \mathbb{1} = \widehat{G}(u)$.

Furthermore, it is useful to express the previous relations by means of matrix representations. The representation given by Eqs. (2.41) and (2.42) is the most convenient for this purpose since it associates compositions of linear maps with compositions of matrices, so that Eq. (3.19) reads

$$K_{\text{TCL}}(t) = \frac{d\Lambda(t, 0)}{dt} \Lambda^{-1}(t, 0), \quad (3.24)$$

while Eq. (3.22) can be written in matrix form as

$$\widehat{K}_{\text{NZ}}(u) = u\mathbb{1} - \widehat{\Lambda}^{-1}(u). \quad (3.25)$$

The dynamical map $\Lambda(t, 0)$ has been our starting point since in this way we could directly show through Eqs. (3.19) and (3.22) that the very same dynamics can be described by both a local and a non-local master equation. However, as recalled in the introduction to this chapter, one usually deals with master equations, so that dynamical maps are obtained by solving them. Given a time-local master equation as in Eq. (3.18), the formal solution is obtained through the Dyson series

$$\begin{aligned} \Lambda(t, 0) &= T_{\leftarrow} \exp \left[\int_0^t d\tau K_{\text{TCL}}(\tau) \right] \\ &\equiv \mathbb{1} + \sum_{k=1}^{\infty} \frac{1}{k!} \int_0^t \dots \int_0^t T_{\leftarrow} K_{\text{TCL}}(t_1) \dots K_{\text{TCL}}(t_k) dt_1 \dots dt_k, \end{aligned} \quad (3.26)$$

where T_{\leftarrow} denotes the chronological time-ordering operator and the convergence of the series is guaranteed since we are dealing with finite dimensional systems and then the time-local generator

$K_{\text{TCL}}(t)$ is bounded. On the other hand, for an integrodifferential equation one has to take the inverse Laplace transform of, see Eq. (3.22),

$$\widehat{\Lambda}(u) = \left(u\mathbb{1} - \widehat{K}_{\text{NZ}}(u) \right)^{-1}. \quad (3.27)$$

Finally, let us note that the equivalence between the local and the non-local description of open-system dynamics can be shown also by means of the damping bases [69]. In fact, consider a dynamical map $\Lambda(t, 0)$ which is the solution of a Nakajima-Zwanzig master equation, i.e. it satisfies Eq. (3.27), and let it be written as, see Eq. (2.70),

$$\Lambda(t, 0)\omega = \sum_{\alpha} \lambda_{\alpha}(t) \text{Tr} [\varsigma_{\alpha}^{\dagger}(t) \omega] \varpi_{\alpha}(t) \quad \omega \in \mathcal{L}(\mathbb{C}^N), \quad (3.28)$$

where the operators $\{\varpi_{\alpha}(t)\}_{\alpha=1, \dots, N^2}$ and $\{\varsigma_{\alpha}(t)\}_{\alpha=1, \dots, N^2}$ define pairs of damping bases, see Eq. (2.72), which are generally different at different times. The inverse map can be formally defined (for t such that $\lambda_{\alpha}(t) \neq 0 \forall \alpha$) as

$$\Lambda^{-1}(t, 0)\omega = \sum_{\alpha} \lambda_{\alpha}^{-1}(t) \text{Tr} [\varsigma_{\alpha}^{\dagger}(t) \omega] \varpi_{\alpha}(t) \quad \omega \in \mathcal{L}(\mathbb{C}^N), \quad (3.29)$$

and, through Eq. (3.19), one can obtain the time-local generator

$$K_{\text{TCL}}(t)\omega = \sum_{\alpha\beta} K_{\alpha\beta}(t) \text{Tr} [\varsigma_{\beta}^{\dagger}(t) \omega] \quad \omega \in \mathcal{L}(\mathbb{C}^N), \quad (3.30)$$

where the terms $K_{\alpha\beta}(t)$ include the operators $\varpi_{\alpha}(t)$ and their time derivatives, see [69]. If the damping bases do not depend on time, Eq. (3.30) reduces to

$$K_{\text{TCL}}(t)\omega = \sum_{\alpha} \frac{\dot{\lambda}_{\alpha}(t)}{\lambda_{\alpha}(t)} \text{Tr} [\varsigma_{\alpha}^{\dagger} \omega] \varpi_{\alpha} \quad \omega \in \mathcal{L}(\mathbb{C}^N), \quad (3.31)$$

in full analogy with the matrix representation given by Eqs. (2.41), (2.42) and (3.24), with the difference that the time-local generator $K_{\text{TCL}}(t)$ is now expanded on its, non orthogonal, eigenbasis. Note that if the damping bases do not depend on time, dynamical maps as well as time-local generators at different times commute

$$\begin{aligned} [\Lambda(t, 0), \Lambda(s, 0)] &= 0, \\ [K_{\text{TCL}}(t), K_{\text{TCL}}(s)] &= 0, \end{aligned} \quad (3.32)$$

and then in Eq. (3.26) the chronological time-ordering operator can be omitted. In Sec. (3.3.3) we will briefly come back to this specific case, which has been widely analyzed in [48, 70].

3.1.3 Trace and hermiticity preservation

As stressed in the previous paragraph, one generally deals with approximated master equations which are not equivalent to the exact total unitary evolution, so that a priori they do not guarantee a well-defined time evolution. Consequently, it is of relevance to identify the operator structure of those master equations which do yield a well-defined time evolution. This task has not been accomplished with full generality yet. Indeed, the difficulty relies on the request that the corresponding dynamical maps have to be completely positive⁴. In this paragraph we show that, however, some general constraints on the structure of the proper master equations can be derived by asking for trace and hermiticity preservation.

Consider a time $t \geq 0$ where the inverse of the dynamical map $\Lambda(t, 0)$ exists, so that a time-local generator $K_{\text{TCL}}(t)$ is uniquely defined. Then, it has to satisfy⁵

$$\begin{aligned} \text{Tr}[K_{\text{TCL}}(t)\omega] &= 0 \quad \forall \omega \in \mathcal{L}(\mathbb{C}^N) \\ (K_{\text{TCL}}(t)\omega)^\dagger &= K_{\text{TCL}}(t)\omega^\dagger \quad \forall \omega \in \mathcal{L}(\mathbb{C}^N), \end{aligned} \quad (3.33)$$

where, indeed, these two conditions express, respectively, trace and hermiticity preservation. Now, consider a linear map Λ on $\mathcal{L}(\mathbb{C}^N)$ and its representation through Eq. (2.50), where the matrix of coefficients Λ' has entries $\Lambda'_{\alpha\beta}$, with $\alpha, \beta = 0, \dots, N^2 - 1$, as in Eq. (2.51) for a basis $\{\sigma_\alpha\}_{\alpha=0, \dots, N^2-1}$ such that

$$\begin{aligned} \sigma_0 &= \mathbb{1}/\sqrt{N} \\ \text{Tr}[\sigma_\alpha] &= 0 \quad \alpha = 1, \dots, N^2 - 1. \end{aligned} \quad (3.34)$$

The Lemma 2.3 in [14] shows that if Λ fulfills $\text{Tr}[\Lambda(\omega)] = 0$ for any $\omega \in \mathcal{L}(\mathbb{C}^N)$, then it can be written as

$$\Lambda(\omega) = -i[H, \omega] + \sum_{\alpha, \beta=1}^{N^2-1} \Lambda'_{\alpha\beta} \left(\sigma_\alpha \omega \sigma_\beta^\dagger - \frac{1}{2} \{ \sigma_\beta^\dagger \sigma_\alpha, \omega \} \right), \quad (3.35)$$

with the coefficients $\Lambda'_{\alpha\beta}$ given by Eq. (2.51) and

$$\begin{aligned} H &= \frac{1}{2i}(\sigma^\dagger - \sigma) \\ \sigma &= \frac{1}{\sqrt{N}} \sum_{\alpha=1}^{N^2-1} \Lambda'_{\alpha 0} \sigma_\alpha. \end{aligned} \quad (3.36)$$

Note that the matrix of coefficients in the second term at the right hand side of Eq. (3.35) is obtained from the matrix Λ' by simply removing the first row and the first column. If we further

⁴Positivity would be in general even more difficult to be verified than complete positivity, since it is connected to the action of the map on the whole set of states, rather than to the eigenvalues of the corresponding Choi matrix, see section (2.2).

⁵The time-local master equation (3.18) *per se* implies that the two conditions in Eq. (3.33) are satisfied if $K_{\text{TCL}}(t)$ is applied to operators into the image of $\Lambda(t, 0)$. But if the latter is invertible, than its image has the same dimensionality of $\mathcal{L}(\mathbb{C}^N)$ and then the two conditions can be extended to the whole space of linear operators. For our purposes, one could equivalently start by assuming the validity of Eq. (3.33).

ask that the linear map Λ is hermiticity-preserving, then the matrix Λ' is hermitian, see Sec. (2.2.1): explicitly,

$$\Lambda'_{\alpha\beta} = \Lambda_{\beta\alpha}^* \quad \forall \alpha, \beta = 0, \dots, N^2 - 1. \quad (3.37)$$

Then, the matrix of coefficients in Eq. (3.35) is hermitian, as well.

Coming back to the time-local generator $K_{\text{TCL}}(t)$, we observe that Eqs. (3.35)-(3.37) can be applied for any fixed time t , with respect to the same basis, because of Eq. (3.33). Thus, we conclude that every time-local master equation satisfying Eq. (3.33) can be written as

$$\frac{d}{dt}\rho(t) = -i[H(t), \rho(t)] + \sum_{\alpha\beta=1}^{N^2-1} K_{\text{TCL}}^{\alpha\beta}(t) \left(\sigma_\alpha \rho(t) \sigma_\beta^\dagger - \frac{1}{2} \left\{ \sigma_\beta^\dagger \sigma_\alpha, \rho(t) \right\} \right), \quad (3.38)$$

with

$$\begin{aligned} H(t) &= \frac{1}{2i}(\sigma(t)^\dagger - \sigma(t)) \\ \sigma(t) &= \frac{1}{\sqrt{N}} \sum_{\alpha=1}^{N^2-1} K_{\text{TCL}}^{\alpha 0}(t) \sigma_\alpha, \end{aligned} \quad (3.39)$$

where the basis $\{\sigma_\alpha\}_{\alpha=0, \dots, N^2-1}$ fulfills Eq. (3.34) and the coefficients $K_{\text{TCL}}^{\alpha\beta*}(t) = K_{\text{TCL}}^{\beta\alpha}(t)$ are given by, see Eq. (2.51),

$$K_{\text{TCL}}^{\alpha\beta}(t) = \sum_{\gamma=0}^{N^2-1} \text{Tr}[\sigma_\beta \sigma_\gamma^\dagger \sigma_\alpha^\dagger K_{\text{TCL}}(t) \sigma_\gamma] \quad \alpha, \beta = 0, \dots, N^2 - 1. \quad (3.40)$$

The first term of the time-local generator in Eq. (3.38) represents a unitary contribution to the dynamics, generated by the self-adjoint operator $H(t)$, while the second term describes the dissipation and the decoherence on the open system due to the interaction with the environment [1], see also Chapter 6. The decomposition into a unitary and a dissipative part provided by Eqs. (3.38)-(3.40) is unique, in the sense that no further contributions to $H(t)$ can be derived from the dissipative part of the generator [71]. Furthermore, the matrix of coefficients in Eq. (3.38) is hermitian since it is obtained from the hermitian matrix with entries as in Eq. (3.40) by removing the first row and the first column. Then, for any time t there is a unitary matrix $V(t)$ such that $K_{\text{TCL}}^{\alpha\beta}(t) = \sum_\gamma V_{\alpha\gamma}(t) k_\gamma(t) V_{\beta\gamma}^*(t)$, for $\alpha, \beta = 1, \dots, N^2 - 1$, with $k_\alpha(t)$ real functions of time. The time-local master equation in Eq. (3.38) can then be written in *diagonal form* as

$$\frac{d}{dt}\rho(t) = -i[H(t), \rho(t)] + \sum_{\alpha=1}^{N^2-1} k_\alpha(t) \left(\tilde{\sigma}_\alpha(t) \rho(t) \tilde{\sigma}_\alpha^\dagger(t) - \frac{1}{2} \left\{ \tilde{\sigma}_\alpha^\dagger(t) \tilde{\sigma}_\alpha(t), \rho(t) \right\} \right), \quad (3.41)$$

where the operators

$$\tilde{\sigma}_\alpha(t) = \sum_{\beta=1}^{N^2-1} V_{\beta\alpha}(t) \sigma_\beta \quad (3.42)$$

for $\alpha = 1, \dots, N^2 - 1$ plus $\tilde{\sigma}_0 = \sigma_0$ provide, at any fixed time t , an orthonormal basis in $\mathcal{L}(\mathbb{C}^N)$ with respect to the Hilbert-Schmidt scalar product. Note that the coefficients $k_\alpha(t)$ and the operators $\tilde{\sigma}_\alpha(t)$ do depend on time since the eigenvalues and eigenvectors of the matrix of coefficients in Eq. (3.38) are generally different at different times. The diagonal form as in Eqs. (3.41) and (3.42) can be considered the canonical form of the time-local generator, since it is obtained from the diagonalization of the coefficient matrix, see the discussion after Eq. (2.64).

Let us now consider integrodifferential master equations as in Eq. (3.17), that in Laplace transform reads as in Eq. (3.21). If $\hat{\Lambda}^{-1}(u)$ exists, then Eq. (3.21) implies that the memory kernel has to satisfy $\text{Tr}[\hat{K}_{\text{NZ}}(u)\omega] = 0, \forall \omega \in \mathcal{L}(\mathbb{C}^N)$, compare with the first of Eq. (3.33). Thus, we can once again use the representation of linear maps given by Eqs. (2.50) and (2.51) and apply, for any fixed u , Eqs. (3.35) and (3.36), thus coming to

$$\hat{K}_{\text{NZ}}(u)\omega = -i[H(u), \omega] + \sum_{\alpha\beta=1}^{N^2-1} \hat{K}_{\text{NZ}}^{\alpha\beta}(u) \left(\sigma_\alpha \omega \sigma_\beta^\dagger - \frac{1}{2} \left\{ \sigma_\beta^\dagger \sigma_\alpha, \omega \right\} \right), \quad (3.43)$$

with $H(u)$ as in Eq. (3.39) and $K_{\text{NZ}}^{\alpha\beta}(u)$ as in Eq. (3.40), but, of course, with $K_{\text{NZ}}(u)$ instead of $K_{\text{TCL}}(t)$. Moreover, Eq. (3.21) implies that for $u \in \mathbb{R}$ the Laplace transform of the memory kernel is hermiticity preserving as well, i.e., $(\hat{K}_{\text{NZ}}(u)\omega)^\dagger = \hat{K}_{\text{NZ}}(u)\omega^\dagger$ for any $\omega \in \mathcal{L}(\mathbb{C}^N)$. Then, the matrix of coefficients in Eq. (3.43) is hermitian, i.e. $\hat{K}_{\text{NZ}}^{\alpha\beta}(u) = (\hat{K}_{\text{NZ}}^{\beta\alpha})^*(u)$. Due to the identity principle, the equality of these two functions can be extended to their common region of analyticity. By exploiting the invertibility of the Laplace transform, we get the same equality for the coefficients of the memory kernel in the temporal domain, i.e., $K_{\text{NZ}}^{\alpha\beta}(t) = (K_{\text{NZ}}^{\beta\alpha})^*(t)$. Thus, we can write the memory kernel as

$$K_{\text{NZ}}(t)\omega = -i[H(t), \omega] + \sum_{\alpha}^{N^2-1} r_\alpha(t) \left(\bar{\sigma}_\alpha(t)\omega\bar{\sigma}_\alpha^\dagger(t) - \frac{1}{2} \left\{ \bar{\sigma}_\alpha^\dagger(t)\bar{\sigma}_\alpha(t), \omega \right\} \right), \quad (3.44)$$

where, indeed the time-dependent real coefficients $r_\alpha(t)$ and linear operators $\bar{\sigma}_\alpha(t)$ are obtained by diagonalizing the matrix with elements $K_{\text{NZ}}^{\alpha\beta}(t)$, compare with Eq. (3.42).

Conversely, consider a time local master equation of the form

$$\frac{d}{dt}\rho(t) = -i[H(t), \rho(t)] + \sum_{\alpha=1}^{N^2-1} k_\alpha(t) \left(\sigma_\alpha(t)\rho(t)\sigma_\alpha^\dagger(t) - \frac{1}{2} \left\{ \sigma_\alpha^\dagger(t)\sigma_\alpha(t), \rho(t) \right\} \right) \quad (3.45)$$

as well as an integrodifferential master equation of the form

$$\begin{aligned} \frac{d}{dt}\rho(t) &= -i \int_0^t d\tau [H(t-\tau), \rho(\tau)] \\ &+ \sum_{\alpha=1}^{N^2-1} \int_0^t d\tau r_\alpha(t-\tau) \left(\sigma_\alpha(t-\tau)\rho(\tau)\sigma_\alpha^\dagger(t-\tau) - \frac{1}{2} \left\{ \sigma_\alpha^\dagger(t-\tau)\sigma_\alpha(t-\tau), \rho(\tau) \right\} \right), \end{aligned} \quad (3.46)$$

with $H^\dagger(t) = H(t)$, $\sigma_\alpha(t) \in \mathcal{L}(\mathbb{C}^N)$ *generic* linear operators on \mathbb{C}^N , $k_\alpha(t)$ and $r_\alpha(t)$ *generic* real functions of t . Then, one can see⁶ that they guarantee trace and hermiticity preservation.

We want to remark that Eq. (3.45) and Eq. (3.46) are not necessarily always the most convenient way in order to express, respectively, time-local generators and memory kernels. In some cases, different structures can be more useful to determine the corresponding dynamical maps or to check whether complete positivity is preserved. An example is given by the master equation introduced in [72], see also [73] where its complete positivity for a two-level system is studied.

3.2 Local versus non-local master equation for the dynamics of a two-level system

In this section, we apply what has been presented in an abstract way in the previous section to a realistic physical model, simple enough to be exactly treated in detail, but already allowing to give some general remarks. Namely, in the first three paragraphs we consider a two-level system coupled first to a single mode of the radiation field and later to a bath of harmonic oscillators at zero temperature, via a Jaynes-Cummings type of interaction. By exploiting the knowledge of the exact unitary evolution, and therefore of the reduced dynamics, we can derive the exact time-convolutionless and Nakajima-Zwanzig master equations. Their operator structures are shown to be generally different, also depending on the environmental state.

Indeed the exact knowledge of the full time evolution is feasible only for exceptional cases. The detailed analysis of such cases, however, proves quite useful in understanding the basic features of the description of open system dynamics; in particular, it puts into evidence the strict relationship between the different quantities which appear in evolution equations, showing that phenomenological ansätze are in general not easily feasible. Moreover, the exact comprehensive study performed in these cases allows to point out general features which can be useful for phenomenological or perturbative treatments, as that presented in the last part of the section. Here, we take into account a more general situation, where the exact solution is no longer available. In particular, we consider an environment consisting of a bath of harmonic oscillators in a thermal state, expanding the time-local generator derived by means of projection operator techniques up to second order. The fourth order term of the expansion is given in Appendix F.

The material of this section is for the most part contained in [28].

3.2.1 Jaynes-Cummings model and exact reduced dynamics

We consider a two-level system coupled to a single mode of the radiation field according to the total Hamiltonian

$$H = H_S + H_E + H_I, \quad (3.47)$$

⁶In fact, the time-local generator in Eq. (3.45) satisfies Eq. (3.33), while the memory kernel in Eq. (3.46) satisfies the analogous relations in Laplace transform. Then, by means of, respectively, Eq. (3.26) and Eq. (3.27), one has that the corresponding evolution maps are trace and hermiticity preserving.

where the system Hamiltonian is given by

$$H_S = \omega_0 \sigma_+ \sigma_-, \quad (3.48)$$

with ω_0 the transition frequency, $\sigma_+ = |1\rangle\langle 0|$ and $\sigma_- = |0\rangle\langle 1|$ the raising and lowering operators of the two-level system. The Hamiltonian for the single mode of the radiation field is given by

$$H_E = \omega b^\dagger b, \quad (3.49)$$

where the creation and annihilation operators b^\dagger and b obey the standard bosonic commutation relation. The coupling is in the Jaynes-Cummings form

$$H_I = g \left(\sigma_+ \otimes b + \sigma_- \otimes b^\dagger \right), \quad (3.50)$$

so that the considered model can describe, e.g., the interaction between a two-level atom and a mode of the radiation field in electric dipole and rotating wave approximation. Working in the interaction picture with respect to the free Hamiltonian $H_S + H_E$,

$$H_I(t) = g \left(\sigma_+ \otimes b e^{i\Delta t} + \sigma_- \otimes b^\dagger e^{-i\Delta t} \right), \quad (3.51)$$

with $\Delta = \omega_0 - \omega$ detuning between the system and the field mode, it is possible to obtain the exact dynamics generated by the total Hamiltonian (see e.g. [74]), and therefore the reduced dynamics of the two-level system. We express the result exhibiting the unitary evolution operator, which in the basis $\{|1\rangle, |0\rangle\}$ is given by the following matrix, whose entries are operators in the Fock space of the radiation field,

$$U(t) = \begin{pmatrix} c(\hat{n} + 1, t) & d(\hat{n} + 1, t) b \\ -b^\dagger d^\dagger(\hat{n} + 1, t) & c^\dagger(\hat{n}, t) \end{pmatrix}, \quad (3.52)$$

where the following operators have been introduced

$$c(\hat{n}, t) = e^{i\Delta t/2} \left[\cos\left(\Omega(\hat{n})\frac{t}{2}\right) - i\Delta \frac{\sin\left(\Omega(\hat{n})\frac{t}{2}\right)}{\Omega(\hat{n})} \right], \quad (3.53)$$

$$d(\hat{n}, t) = -ie^{i\Delta t/2} 2g \frac{\sin\left(\Omega(\hat{n})\frac{t}{2}\right)}{\sqrt{\Delta^2 + 4g^2\hat{n}}}, \quad (3.54)$$

with

$$\Omega(\hat{n}) = \sqrt{\Delta^2 + 4g^2\hat{n}}, \quad (3.55)$$

and $\hat{n} = b^\dagger b$ is the number operator. The unitarity of $U(t)$ is granted because of the easily verified relation

$$c^\dagger(\hat{n}, t) c(\hat{n}, t) + \hat{n} d^\dagger(\hat{n}, t) d(\hat{n}, t) = 1. \quad (3.56)$$

Given the unitary evolution of the whole bipartite system and assuming a product total initial state, one can obtain the reduced dynamics of the two-level atom simply by taking the partial trace with

respect to the environmental degrees of freedom, see Eq. (2.94). Taking $U(t)$ as in Eq. (3.52) and considering an environmental state commuting with the number operator, $[\rho_E, \hat{n}] = 0$, so that in particular both the vacuum and a thermal state can be dealt with, one comes to the following explicit expression for the action of the map $\Lambda(t, 0)$:

$$\begin{aligned} \rho(0) = \begin{pmatrix} \rho_{11} & \rho_{10} \\ \rho_{01} & \rho_{00} \end{pmatrix} \mapsto \rho(t) &= \Lambda(t, 0)\rho(0) \\ &= \begin{pmatrix} \rho_{00}(1 - \alpha(t)) + \rho_{11}\beta(t) & \rho_{10}\gamma(t) \\ \rho_{01}\gamma^*(t) & \rho_{00}\alpha(t) + \rho_{11}(1 - \beta(t)) \end{pmatrix}. \end{aligned} \quad (3.57)$$

The effect of the interaction with the bath is contained in the time dependent coefficients $\alpha(t)$, $\beta(t)$ and $\gamma(t)$, which are given by the following expectation values over the state of the environment ρ_E , see Eq. (2.20):

$$\begin{aligned} \alpha(t) &= \langle c^\dagger(\hat{n}, t) c(\hat{n}, t) \rangle_E, \\ \beta(t) &= \langle c^\dagger(\hat{n} + 1, t) c(\hat{n} + 1, t) \rangle_E, \\ \gamma(t) &= \langle c(\hat{n}, t) c(\hat{n} + 1, t) \rangle_E. \end{aligned} \quad (3.58)$$

Now that we have obtained the completely positive map $\Lambda(t, 0)$ giving the exact reduced time evolution of the considered two-level system, we can exploit the representations of linear maps introduced in the previous chapter. Consider in particular the representation given by Eqs. (2.41) and (2.42) with respect to the orthonormal basis of operators $\left\{ \frac{1}{\sqrt{2}}\mathbb{1}, \frac{1}{\sqrt{2}}\sigma_k \right\}$, where now σ_k denote the usual Pauli operators, see Eq. (2.77). This choice leads to the following expression for the matrix $\Lambda(t)$ associated with the time evolution map $\Lambda(t, 0)$:

$$\Lambda(t, 0) = \begin{pmatrix} 1 & 0 & 0 & 0 \\ 0 & \gamma_R(t) & \gamma_I(t) & 0 \\ 0 & -\gamma_I(t) & \gamma_R(t) & 0 \\ \beta(t) - \alpha(t) & 0 & 0 & \beta(t) + \alpha(t) - 1 \end{pmatrix}, \quad (3.59)$$

where the coefficients defined in Eq. (3.58) appear, and we denote with R and I real and imaginary part of a given function: $\gamma = \gamma_R + i\gamma_I$. For any fixed time t , the linear map in Eq. (3.59) describes a translation along the z -axis plus a rotation and a contraction of the Bloch sphere, see Sec. (2.2.4); recall that the complete positivity is guaranteed since we are dealing with the exact reduced dynamics.

3.2.2 Exact time-convolutionless and Nakajima-Zwanzig master equations

With the aid of the exact time evolution, and using the representation of maps in terms of matrices, we will now explicitly obtain a local and a non-local exact equation of motion for the reduced-

system dynamics. Starting from Eq. (3.59) and Eq. (3.24) one obtains for the model of interest

$$K_{\text{TCL}}(t) = \begin{pmatrix} 0 & 0 & 0 & 0 \\ 0 & \text{Re} \left[\frac{\dot{\gamma}(t)}{\gamma(t)} \right] & \text{Im} \left[\frac{\dot{\gamma}(t)}{\gamma(t)} \right] & 0 \\ 0 & -\text{Im} \left[\frac{\dot{\gamma}(t)}{\gamma(t)} \right] & \text{Re} \left[\frac{\dot{\gamma}(t)}{\gamma(t)} \right] & 0 \\ \frac{[1-2\beta(t)]\dot{\alpha}(t) - [1-2\alpha(t)]\dot{\beta}(t)}{\beta(t) + \alpha(t) - 1} & 0 & 0 & \frac{\dot{\beta}(t) + \dot{\alpha}(t)}{\beta(t) + \alpha(t) - 1} \end{pmatrix}, \quad (3.60)$$

and the expression is well defined provided the determinant

$$\det \Lambda(t) = |\gamma(t)|^2 [\alpha(t) + \beta(t) - 1] \quad (3.61)$$

is different from zero. On a similar footing one can consider the Laplace transform of Eq. (3.59), given by the matrix $\widehat{\Lambda}(u)$ with determinant

$$\det \widehat{\Lambda}(u) = \left[\widehat{\gamma}_R^2(u) + \widehat{\gamma}_I^2(u) \right] \left[\frac{\widehat{\alpha}(u) + \widehat{\beta}(u)}{u} - \frac{1}{u^2} \right], \quad (3.62)$$

and using Eq. (3.25) one further obtains

$$\widehat{K}_{\text{NZ}}(u) = \begin{pmatrix} 0 & 0 & 0 & 0 \\ 0 & u - \frac{\widehat{\gamma}_R(u)}{\widehat{\gamma}_R^2(u) + \widehat{\gamma}_I^2(u)} & \frac{\widehat{\gamma}_I(u)}{\widehat{\gamma}_R^2(u) + \widehat{\gamma}_I^2(u)} & 0 \\ 0 & -\frac{\widehat{\gamma}_I(u)}{\widehat{\gamma}_R^2(u) + \widehat{\gamma}_I^2(u)} & u - \frac{\widehat{\gamma}_R(u)}{\widehat{\gamma}_R^2(u) + \widehat{\gamma}_I^2(u)} & 0 \\ \frac{u^2[\widehat{\alpha}(u) - \widehat{\beta}(u)]}{1 - u[\widehat{\alpha}(u) + \widehat{\beta}(u)]} & 0 & 0 & \frac{2u - u^2[\widehat{\alpha}(u) + \widehat{\beta}(u)]}{1 - u[\widehat{\alpha}(u) + \widehat{\beta}(u)]} \end{pmatrix}, \quad (3.63)$$

which upon inverse Laplace transform provides the exact Nakajima-Zwanzig integral kernel. As it appears, working with the matrix representation has proved very convenient to easily obtain the maps fixing the time-local and integrodifferential equations of motion for the model, given by Eq. (3.18) and Eq. (3.17) respectively, in terms of the dynamical map Eq. (3.57).

Maps in canonical form

We now recast the obtained maps in operator form, to better compare with previous work and appreciate the difference in the obtained expressions. In particular, we follow the procedure presented in the previous section that allows to get the canonical form of linear maps.

Consider a matrix of the form

$$A = \begin{pmatrix} 0 & 0 & 0 & 0 \\ 0 & E_r & E_i & 0 \\ 0 & -E_i & E_r & 0 \\ X & 0 & 0 & Y \end{pmatrix} \quad (3.64)$$

with respect to the representation given by Eqs. (2.41) and (2.42), in the basis $\left\{ \frac{1}{\sqrt{2}} \mathbb{1}, \frac{1}{\sqrt{2}} \sigma_k \right\}$, where recall that now σ_k denote the usual Pauli operators. To move into the representation given

by Eqs. (2.50) and (2.51), one can directly connect the coefficients of the matrix Λ in Eq. (2.42) and those of the matrix Λ' in Eq. (2.51). In fact, by substituting Eq. (2.41) into Eq. (2.51), one has

$$\Lambda'_{\alpha'\beta'} = \sum_{\alpha\beta} \Lambda_{\alpha\beta} \text{Tr}[\sigma_{\beta'}\sigma_{\beta}^{\dagger}\sigma_{\alpha'}^{\dagger}\sigma_{\alpha}]. \quad (3.65)$$

Indeed, last term in the previous relation defines a 16×16 matrix, which expresses the change of basis in $\mathcal{LL}(\mathbb{C}^N)$ from $\{E_{\alpha\beta}\}_{\alpha\beta=1,\dots,4}$ to $\{F_{\alpha\beta}\}_{\alpha\beta=1,\dots,4}$, see Eqs. (2.44) and (2.45). In fact, it holds, see Eq. (2.43),

$$\langle\langle F_{\alpha'\beta'}, E_{\alpha\beta} \rangle\rangle = \text{Tr}[\sigma_{\beta'}\sigma_{\beta}^{\dagger}\sigma_{\alpha'}^{\dagger}\sigma_{\alpha}]. \quad (3.66)$$

Applying Eq. (3.65) to the matrix A in Eq. (3.64), we come to

$$A' = \begin{pmatrix} E_r + Y/2 & 0 & 0 & -iE_i + X/2 \\ 0 & -Y/2 & -iX/2 & 0 \\ 0 & iX/2 & -Y/2 & 0 \\ iE_i + X/2 & 0 & 0 & Y/2 - E_r \end{pmatrix}. \quad (3.67)$$

The basis we are using satisfies Eq. (3.34). Then, to obtain the canonical form of the linear map A associated with A and A' , we simply have to diagonalize the matrix which is obtained by removing the first row and the first column to Eq. (3.67), see Eqs. (3.41) and (3.42), and to introduce an Hamiltonian term through Eq. (3.39). Thus, we get

$$\begin{aligned} A(\omega) &= iE_i[\sigma_+\sigma_-, \omega] + \frac{1}{2}(X - Y) \left[\sigma_+\omega\sigma_- - \frac{1}{2}\{\sigma_-\sigma_+, \omega\} \right] \\ &\quad - \frac{1}{2}(X + Y) \left[\sigma_-\omega\sigma_+ - \frac{1}{2}\{\sigma_+\sigma_-, \omega\} \right] + \frac{1}{4}(Y - 2E_r) [\sigma_z\omega\sigma_z - \omega], \end{aligned} \quad (3.68)$$

whose last term can be written in alternative ways according to the identities

$$\sigma_z\omega\sigma_z - \omega = 4 \left[\sigma_+\sigma_-\omega\sigma_+\sigma_- - \frac{1}{2}\{\sigma_+\sigma_-, \omega\} \right] = 4 \left[\sigma_-\sigma_+\omega\sigma_-\sigma_+ - \frac{1}{2}\{\sigma_-\sigma_+, \omega\} \right]. \quad (3.69)$$

Exploiting this result, one obtains the exact time-convolutionless master equation describing the reduced dynamics of a two-level atom coupled according to the Jaynes-Cummings model to a single mode of the radiation field, which is of the form Eq. (3.18) with $K_{\text{TCL}}(t)$ given by

$$\begin{aligned} K_{\text{TCL}}(t)\omega &= i \text{Im} \left[\frac{\dot{\gamma}(t)}{\gamma(t)} \right] [\sigma_+\sigma_-, \omega] + \frac{[\alpha(t) - 1]\dot{\beta}(t) - \beta(t)\dot{\alpha}(t)}{\beta(t) + \alpha(t) - 1} \left[\sigma_+\omega\sigma_- - \frac{1}{2}\{\sigma_-\sigma_+, \omega\} \right] \\ &\quad + \frac{[\beta(t) - 1]\dot{\alpha}(t) - \alpha(t)\dot{\beta}(t)}{\beta(t) + \alpha(t) - 1} \left[\sigma_-\omega\sigma_+ - \frac{1}{2}\{\sigma_+\sigma_-, \omega\} \right] \\ &\quad + \frac{1}{4} \left\{ \frac{\dot{\beta}(t) + \dot{\alpha}(t)}{\beta(t) + \alpha(t) - 1} - 2 \text{Re} \left[\frac{\dot{\gamma}(t)}{\gamma(t)} \right] \right\} [\sigma_z\omega\sigma_z - \omega]. \end{aligned} \quad (3.70)$$

In a similar way, one has for the Laplace transform of the memory kernel $K_{\text{NZ}}(t)$, appearing in the exact Nakajima-Zwanzig master equation Eq. (3.17), the expression

$$\begin{aligned} \widehat{K}_{\text{NZ}}(u)\omega &= i \frac{\widehat{\gamma}_I(u)}{\widehat{\gamma}_R^2(u) + \widehat{\gamma}_I^2(u)} [\sigma_+\sigma_-, \omega] + \frac{u[u\widehat{\alpha}(u) - 1]}{1 - u[\widehat{\alpha}(u) + \widehat{\beta}(u)]} \left[\sigma_+\omega\sigma_- - \frac{1}{2} \{\sigma_-\sigma_+, \omega\} \right] \\ &+ \frac{u[u\widehat{\beta}(u) - 1]}{1 - u[\widehat{\alpha}(u) + \widehat{\beta}(u)]} \left[\sigma_-\omega\sigma_+ - \frac{1}{2} \{\sigma_+\sigma_-, \omega\} \right] \\ &+ \frac{1}{4} \left\{ \frac{u^2[\widehat{\alpha}(u) + \widehat{\beta}(u)]}{1 - u[\widehat{\alpha}(u) + \widehat{\beta}(u)]} + 2 \frac{\widehat{\gamma}_R(u)}{\widehat{\gamma}_R^2(u) + \widehat{\gamma}_I^2(u)} \right\} [\sigma_z\omega\sigma_z - \omega]. \end{aligned} \quad (3.71)$$

Despite being exact these expressions are quite cumbersome, since the functions given in Eq. (3.58), which together with their Laplace transform determine the structure of these operators, depend on the specific expression of the environmental state. It is therefore convenient to consider a specific choice, allowing for a more detailed evaluation.

The vacuum case

If the radiation field is in the vacuum state, the functions given in Eq. (3.58) simplify considerably, since $\alpha(t) \rightarrow 1$, while $\beta(t)$ becomes a function of $\gamma(t)$ according to $\beta(t) \rightarrow |\gamma(t)|^2$. The function $\gamma(t)$ for the vacuum case is given by the expression

$$G^1(t) = e^{i\Delta t/2} \left[\cos\left(\frac{\Omega_1 t}{2}\right) - i \frac{\Delta}{\Omega_1} \sin\left(\frac{\Omega_1 t}{2}\right) \right], \quad (3.72)$$

where the superscript recalls that we have a single mode of the radiation field, while $\Omega_1 = \sqrt{\Delta^2 + 4g^2}$, see Eq. (3.55). These results for the vacuum case greatly simplify the expression of the obtained master equations, and inserted in Eq. (3.61) show that the time-convolutionless master equation off-resonance is always well defined. The time-local generator for the vacuum case reads

$$\begin{aligned} K_{\text{TCL}}^{\text{Vac}}(t)\omega &= -ig^2\Delta \frac{1 - \cos(\Omega_1 t)}{\Omega_1} \left[\cos^2\left(\frac{\Omega_1 t}{2}\right) + \frac{\Delta^2}{\Omega_1^2} \sin^2\left(\frac{\Omega_1 t}{2}\right) \right]^{-1} [\sigma_+\sigma_-, \omega] \\ &+ 2g^2 \frac{\sin(\Omega_1 t)}{\Omega_1} \left[\cos^2\left(\frac{\Omega_1 t}{2}\right) + \frac{\Delta^2}{\Omega_1^2} \sin^2\left(\frac{\Omega_1 t}{2}\right) \right]^{-1} \left[\sigma_-\omega\sigma_+ - \frac{1}{2} \{\sigma_+\sigma_-, \omega\} \right], \end{aligned} \quad (3.73)$$

where in particular one directly sees that the coefficient in front of the dissipative term at the r.h.s. of Eq. (3.73) periodically takes on negative values. The choice of the vacuum as bath state brings in important simplifications also for the expression of the Nakajima-Zwanzig memory kernel, which reads

$$\begin{aligned} K_{\text{NZ}}^{\text{Vac}}(\tau)\omega &= -ig^2 \sin(\Delta\tau) [\sigma_+\sigma_-, \omega] + 2g^2 \cos\left(\sqrt{\Delta^2 + 2g^2}\tau\right) \left[\sigma_-\omega\sigma_+ - \frac{1}{2} \{\sigma_+\sigma_-, \omega\} \right] \\ &- \frac{1}{2}g^2 \left[\cos\left(\sqrt{\Delta^2 + 2g^2}\tau\right) - \cos(\Delta\tau) \right] [\sigma_z\omega\sigma_z - \omega], \end{aligned} \quad (3.74)$$

which is always well-defined even on-resonance.

3.2.3 Bath of harmonic oscillators at zero temperature

We consider now the case in which the environmental Hamiltonian is a collection of harmonic oscillators

$$H_E = \sum_k \omega_k b_k^\dagger b_k, \quad (3.75)$$

and the interaction Hamiltonian is replaced by

$$H_I = \sum_k \left(g_k \sigma_+ \otimes b_k + g_k^* \sigma_- \otimes b_k^\dagger \right). \quad (3.76)$$

This model corresponds, for a Lorentzian spectral density, to the damped Jaynes-Cummings model. The time evolution map for this model, considering the special case of an environment in the vacuum state, i.e. at zero temperature, has been obtained in [66] and can be expressed as:

$$\rho(0) = \begin{pmatrix} \rho_{11} & \rho_{10} \\ \rho_{01} & \rho_{00} \end{pmatrix} \mapsto \rho(t) = \Lambda^{\text{DVac}}(t)\rho(0) = \begin{pmatrix} \rho_{11} |G(t)|^2 & \rho_{10} G(t) \\ \rho_{01} G^*(t) & \rho_{00} + \rho_{11} (1 - |G(t)|^2) \end{pmatrix}. \quad (3.77)$$

where $\rho(t) = \Lambda^{\text{DVac}}(t)\rho(0)$, since we are considering the damped model with the bath in the vacuum state. The function $G(t)$ is the solution of the equation

$$\frac{d}{dt}G(t) = - \int_0^t dt_1 f(t-t_1) G(t_1) \quad G(0) = 1, \quad (3.78)$$

with $f(t)$ the two-point correlation function given by

$$f(t-t_1) = e^{i\omega_0(t-t_1)} \langle 0 | \sum_k g_k b_k e^{-i\omega_k t} \sum_j g_j^* b_j^\dagger e^{i\omega_j t_1} | 0 \rangle = \sum_k |g_k|^2 e^{i(\omega_0 - \omega_k)(t-t_1)}, \quad (3.79)$$

corresponding to the Fourier transform of the spectral density. Starting from Eq. (3.77) one immediately obtains for the matrix representation of the time-convolutionless generator the expression

$$K_{\text{TCL}}^{\text{DVac}}(t) = \begin{pmatrix} 0 & 0 & 0 & 0 \\ 0 & \text{Re} \left[\frac{\dot{G}(t)}{G(t)} \right] & \text{Im} \left[\frac{\dot{G}(t)}{G(t)} \right] & 0 \\ 0 & -\text{Im} \left[\frac{\dot{G}(t)}{G(t)} \right] & \text{Re} \left[\frac{\dot{G}(t)}{G(t)} \right] & 0 \\ 2 \text{Re} \left[\frac{\dot{G}(t)}{G(t)} \right] & 0 & 0 & 2 \text{Re} \left[\frac{\dot{G}(t)}{G(t)} \right] \end{pmatrix}, \quad (3.80)$$

that in operator form reads

$$K_{\text{TCL}}^{\text{DVac}}(t)\omega = +i \text{Im} \left[\frac{\dot{G}(t)}{G(t)} \right] [\sigma_+ \sigma_-, \omega] - 2 \text{Re} \left[\frac{\dot{G}(t)}{G(t)} \right] \left[\sigma_- \omega \sigma_+ - \frac{1}{2} \{ \sigma_+ \sigma_-, \omega \} \right], \quad (3.81)$$

which confirms the result obtained in [1]. One can also determine the expression of the Nakajima-Zwanzig memory kernel, whose Laplace transform is given by

$$\mathcal{K}_{\text{NZ}}^{\text{DVac}}(u) = \begin{pmatrix} 0 & 0 & 0 & 0 \\ 0 & u - \frac{\widehat{G}_R(u)}{\widehat{G}_R^2(u) + \widehat{G}_I^2(u)} & \frac{\widehat{G}_I(u)}{\widehat{G}_R^2(u) + \widehat{G}_I^2(u)} & 0 \\ 0 & -\frac{\widehat{G}_I(u)}{\widehat{G}_R^2(u) + \widehat{G}_I^2(u)} & u - \frac{\widehat{G}_R(u)}{\widehat{G}_R^2(u) + \widehat{G}_I^2(u)} & 0 \\ \frac{u\widehat{z}(u)-1}{\widehat{z}(u)} & 0 & 0 & \frac{u\widehat{z}(u)-1}{\widehat{z}(u)} \end{pmatrix}, \quad (3.82)$$

where we have used the notation $z(t) = |G(t)|^2$, leading to

$$\begin{aligned} \widehat{K}_{\text{NZ}}^{\text{Vac}}(u)\omega = & +i \frac{\widehat{G}_I(u)}{\widehat{G}_R^2(u) + \widehat{G}_I^2(u)} [\sigma_+ \sigma_-, \omega] + \left[\frac{1 - u\widehat{z}(u)}{\widehat{z}(u)} \right] \left[\sigma_- \omega \sigma_+ - \frac{1}{2} \{ \sigma_+ \sigma_-, \omega \} \right] \\ & - \frac{1}{4} \left[\frac{1 - u\widehat{z}(u)}{\widehat{z}(u)} + 2 \left(u - \frac{\widehat{G}_R(u)}{\widehat{G}_R^2(u) + \widehat{G}_I^2(u)} \right) \right] [\sigma_z \omega \sigma_z - \omega] \end{aligned} \quad (3.83)$$

For the case of a single mode the correlation function considered in Eq. (3.79) explicitly becomes

$$f^1(t) = g^2 e^{i\Delta t}, \quad (3.84)$$

where the superscript again stresses the fact that a single mode is considered. The solution of the integrodifferential Eq. (3.78) is then exactly given by the function $G^1(t)$ introduced in Eq. (3.72). As it should be, Eq. (3.73) and Eq. (3.74) are obtained from Eq. (3.81) and Eq. (3.83) under the replacement $G(t) \rightarrow G^1(t)$, which corresponds to the special choice of a single mode bath.

These results already allow for a few important remarks. We first notice that the different operator contributions appearing in the various time-local and integral kernels are multiplied by different time dependent functions [75, 76]. More than this, for the same model different sets of equations of motion can have different operator structures, as it appears comparing, e.g., the time-convolutionless and Nakajima-Zwanzig results for the vacuum Eq. (3.73) and Eq. (3.74) or, in the case of a bath of oscillators, Eq. (3.81) and Eq. (3.83). The present analysis shows that this asymmetry, already noticed in [77], depends on the choice of environmental state. For the present model it only appears in connection with the vacuum state, see Eqs. (3.70) and (3.71) for the case of a thermal state. This is an explicit example on how the choice of the initial state for the environment influences the operator structure of master equations. Indeed, while the disappearance of the term corresponding to excitation of the two-level system is obvious on physical grounds, when considering as bath state the vacuum, the vanishing of the coefficient in front of the dephasing term $\sigma_z \rho(t) \sigma_z - \rho(t)$ is a peculiar feature of the time-convolutionless master equation.

3.2.4 Perturbative expansion of the time-local master equation for a thermal bath

The analysis performed so far can give useful indications in order to deal with more complex situations where the exact solution of the total dynamics is no longer available. Let us consider a generalization of the previous model, namely a two level system coupled, via a Jaynes-Cummings

interaction, to a bath of harmonic oscillators initially in a thermal state. In this case a perturbative expansion of the total unitary dynamics is needed. In particular, we perform the expansion of the time-convolutionless master equation which has been obtained via projection operator techniques, see Eqs. (3.14) with $\mathcal{K}_{TCL}(t)$ as in Eq. (3.15) and $\mathcal{I}(t) = 0$ since we are assuming a product initial state. In this paragraph we explicitly calculate the second order of the expansion, while the fourth order is derived in Appendix A.

Before moving to the specific case under investigation, we briefly present the general perturbative expansion of time-local generators defined via projection operator techniques. For the analogous discussion on integrodifferential equations the reader is referred to [1], while a different perturbative expansion for reduced-system dynamics is presented in [78]. We introduce a dimensionless expansion parameter α , redefining $H_I \rightarrow \alpha H_I$, so that $L(t) \rightarrow \alpha L(t)$ and then $\Sigma(t) \rightarrow \alpha \Sigma(t)$, see Eq. (3.12). Since $\Sigma(t)$ is equal to 0 for $t = t_0 = 0$ and for $\alpha = 0$, one concludes that $1 - \Sigma(t)$ can always be inverted on short time scales and for small coupling α . By further assuming that $\Sigma(t)$ may be expanded into a geometric series

$$[1 - \Sigma(t)]^{-1} = \sum_{n=0}^{\infty} [\Sigma(t)]^n, \quad (3.85)$$

Eq. (3.15) becomes

$$\mathcal{K}_{TCL}(t) = \alpha \sum_{n=0}^{\infty} PL(t) [\Sigma(t)]^n P = \sum_{n=1}^{\infty} \alpha^n \mathcal{K}_{TCL}^{(n)}(t). \quad (3.86)$$

To determine the contribution $\mathcal{K}_{TCL}^{(n)}(t)$ of n -th order in α , one expands also $\Sigma(t)$ in powers of α :

$$\Sigma(t) = \sum_{n=1}^{\infty} \alpha^n \Sigma^{(n)}(t). \quad (3.87)$$

Then, Eq. (3.86) implies the following equalities, up to fourth order:

$$\begin{aligned} \mathcal{K}_{TCL}^{(1)}(t) &= PL(t)P \\ \mathcal{K}_{TCL}^{(2)}(t) &= PL(t)\Sigma^{(1)}(t)P \\ \mathcal{K}_{TCL}^{(3)}(t) &= PL(t)\{[\Sigma^{(1)}(t)]^2 + \Sigma^{(2)}(t)\}P \\ \mathcal{K}_{TCL}^{(4)}(t) &= PL(t)\{[\Sigma^{(1)}(t)]^3 + \Sigma^{(1)}(t)\Sigma^{(2)}(t) + \Sigma^{(2)}(t)\Sigma^{(1)}(t) + \Sigma^{(3)}(t)\}P, \end{aligned} \quad (3.88)$$

where the terms $\Sigma^{(n)}(t)$ are obtained from Eq. (3.12) by expanding the propagators $D(t, s)$ and $G(t, s)$ in powers of α . The second order contribution in Eq. (3.88), for example, reads

$$\mathcal{K}_{TCL}^{(2)}(t) = \int_0^t dt_1 PL(t)L(t_1)P. \quad (3.89)$$

A general expression for the n -th order contribution $\mathcal{K}_{TCL}^{(n)}(t)$ can be derived by cumulant expansions [79, 80, 1].

Let us apply this general analysis to the dynamics of a two-level system interacting through Eqs. (3.48), (3.75) and (3.76) with a bath of harmonic oscillators initially in a thermal state ρ_E , such that $[\rho_E, \hat{n}] = 0$. In interaction picture

$$H_I(t) = \sigma_+(t) \otimes B(t) + \sigma_-(t) \otimes B^\dagger(t), \quad (3.90)$$

with

$$\begin{aligned} \sigma_\pm(t) &= e^{\pm i\omega_0 t} \sigma_\pm \\ B(t) &= \sum_k g_k b_k e^{-i\omega_k t}. \end{aligned} \quad (3.91)$$

For this Hamiltonian one can see that the first as well as the third order contributions to the expansion of the time-local generator vanish. From Eqs. (3.3) and (3.89) one immediately obtains the second order contribution to the time-convolutionless master equation for the reduced dynamics according to

$$K_{\text{TCL}}^{(2)}(t)\rho(t) = \text{tr}_E \left\{ \int_0^t dt_1 L(t)L(t_1)\rho(t) \otimes \rho_E \right\}, \quad (3.92)$$

The second order contribution Eq. (3.92) can be expressed by means of the following two correlation functions:

$$f(t-t_1) = e^{i\omega_0(t-t_1)} \text{tr}_E \left\{ B(t)B^\dagger(t_1)\rho_E \right\} = \sum_k |g_k|^2 e^{i(\omega_0-\omega_k)(t-t_1)} \langle n_k + 1 \rangle_E, \quad (3.93)$$

which corresponds to Eq. (3.79) if the bath is in the vacuum state, and

$$g(t-t_1) = e^{-i\omega_0(t-t_1)} \text{tr}_E \left\{ B^\dagger(t)B(t_1)\rho_E \right\} = \sum_k |g_k|^2 e^{-i(\omega_0-\omega_k)(t-t_1)} \langle n_k \rangle_E, \quad (3.94)$$

which vanishes in the vacuum. In terms of these functions one has

$$\begin{aligned} PL(t_\alpha)L(t_\beta)P\omega \otimes \rho_E &= -[f(t_\alpha-t_\beta)\sigma_+\sigma_-\omega + f^*(t_\alpha-t_\beta)\omega\sigma_+\sigma_- \\ &\quad + g(t_\alpha-t_\beta)\sigma_-\sigma_+\omega + g^*(t_\alpha-t_\beta)\omega\sigma_-\sigma_+ \\ &\quad - 2\text{Re} f(t_\alpha-t_\beta)\sigma_-\omega\sigma_+ - 2\text{Re} g(t_\alpha-t_\beta)\sigma_+\omega\sigma_-] \otimes \rho_E. \end{aligned} \quad (3.95)$$

This result is sufficient to obtain the time-convolutionless master equation up to second order: upon inserting Eq. (3.95) in Eq. (3.92) one gets

$$\begin{aligned} K_{\text{TCL}}^{(2)}(t)\rho(t) &= -i [f_I(t) + g_I(t)] [\sigma_+\sigma_-, \rho(t)] + 2f_R(t) \left[\sigma_+\rho(t)\sigma_- - \frac{1}{2} \{\sigma_-\sigma_+, \rho(t)\} \right] \\ &\quad + 2g_R(t) \left[\sigma_-\rho(t)\sigma_+ - \frac{1}{2} \{\sigma_+\sigma_-, \rho(t)\} \right], \end{aligned} \quad (3.96)$$

where we have set

$$\begin{aligned}\mathfrak{f}(t) &= \int_0^t dt_1 f(t-t_1) \\ \mathfrak{g}(t) &= \int_0^t dt_1 g(t-t_1),\end{aligned}\tag{3.97}$$

denoting as usual real and imaginary parts with the subscripts R and I respectively.

We thus see that the possibility to express all relevant functions appearing in the master equation with reference to the single correlation function $f(t)$ is a special feature of the two-level system coupled to the vacuum. Furthermore, we have seen that in the case of a single mode of the radiation field the time-convolutionless generator has a different operator structure with respect to the Nakajima-Zwanzig memory kernel only for the case of the vacuum, as it appears comparing Eq. (3.73) and Eq. (3.74), while this is no longer true for a thermal state, see Eqs. (3.70) and (3.71). This strongly suggests that the asymmetry in the operator structure of Eq. (3.81) and Eq. (3.83) in the case of a bath of harmonic oscillators is also due to the vacuum initial environmental state. However, we can see from Eq. (3.96) that the second order is not enough to confirm this fact. The necessity to go up to the fourth perturbative order is immediately clear looking at the interaction Hamiltonian in Eq. (3.76), and observing that the dephasing term, as it appears from Eq. (3.69), involves a quadrilinear contribution in the raising and lowering operators σ_+ and σ_- . This task has been accomplished in Appendix F, leading to the result

$$\begin{aligned}K_{\text{TCL}}^D(t)\rho(t) &= i \text{Im} \gamma_s(t) [\sigma_+\sigma_-, \rho(t)] + \gamma_+(t) \left[\sigma_+\rho(t)\sigma_- - \frac{1}{2} \{\sigma_-\sigma_+, \rho(t)\} \right] \\ &\quad + \gamma_-(t) \left[\sigma_-\rho(t)\sigma_+ - \frac{1}{2} \{\sigma_+\sigma_-, \rho(t)\} \right] + \frac{1}{4} \gamma_d(t) [\sigma_z\rho(t)\sigma_z - \rho(t)],\end{aligned}\tag{3.98}$$

and the detailed expression of the various coefficients in terms of two- and four-points correlation functions of the system can be found in Eq. (F.9) of Appendix F. This result shows that indeed the disappearance of the dephasing term in the time-convolutionless master equation for the vacuum is a very special feature of this choice of the bath state.

3.3 Master equations and complete positivity

In the previous section, we have presented a simple example of how to obtain a master equation that properly describes the dynamics of an open system. More generally, starting from the total unitary evolution, one performs an average over the degrees of freedom of the environment by means of partial trace, introducing some suitable approximations which depend in a crucial way on details of the system and interaction. These approximations determine the conditions under which the resulting master equation is expected to provide a realistic description of the dynamics under investigation. However, since the equivalence with the full unitary evolution has been lost, the complete positivity and even the positivity of the evolution are no longer guaranteed. It is then of paramount importance to introduce general criteria that allow to identify those master equations

which do provide a well-defined description of the reduced dynamics.

A very important result has been obtained for completely positive quantum dynamical semigroups: the expression of the generators of such semigroups, which gives the master equation for the reduced statistical operator, has been in fact fully characterized [14, 15]. The resulting master equation, which is called *Gorini-Kossakowski-Sudarshan-Lindblad equation*, or often simply *Lindblad equation*, is a valuable reference structure in the study of open-system dynamics. The physical meaning of quantum dynamical semigroups relies on the fact that, generally speaking, they describe dynamics in which the memory effects due to the interaction with the environment can be neglected. For this reason they are often referred to as quantum Markovian dynamics and they are interpreted as the quantum counterpart of classical Markovian stochastic processes. Nevertheless, the concept of Markovianity in the quantum setting is quite subtle and it is not as firmly established as in the classical case, as we will see in the next chapter where the relation between classical stochastic processes and quantum Markovian dynamics is discussed in detail.

3.3.1 Dynamical semigroups: the Gorini-Kossakowski-Sudarshan-Lindblad equation

A *completely positive quantum dynamical semigroup* is a strongly continuous one-parameter semigroup of completely positive trace preserving linear maps on the set of trace class operators [81, 14]. We have reported in Appendix B some results on the theory of one-parameter semigroups which will be useful in the following. Here, we consider a one-parameter family of reduced dynamical maps $\{\Lambda(t, 0)\}_{t \geq 0}$, with fixed initial time $t_0 = 0$. According to Eq. (B.1), this is a one-parameter semigroup if it satisfies the following conditions:

$$\begin{aligned}\Lambda(0, 0) &= \mathbb{1} \\ \Lambda(t, 0)\Lambda(s, 0) &= \Lambda(t + s, 0) \quad \forall t, s \geq 0.\end{aligned}\tag{3.99}$$

Completely positive quantum dynamical semigroups represent an important and general class of quantum evolutions that can be fully characterized. A basic role is here played by complete positivity. It is in fact the request that every dynamical map $\Lambda(t, 0)$ satisfies such condition, stronger than the simple positivity, that allows to explicitly characterize the generator of the semigroup. This is due to the well-known Gorini-Kossakowski-Sudarshan-Lindblad theorem, which in the finite dimensional case reads [14]:

Theorem (GKSL) A linear operator L on $\mathcal{L}(\mathbb{C}^N)$ is the generator⁷ of a completely positive quantum dynamical semigroup $\{\Lambda(t, 0)\}_{t \geq 0}$, with

$$\Lambda(t, 0) = e^{Lt},\tag{3.100}$$

⁷Every linear map $L \in \mathcal{L}(\mathbb{C}^N)$ on the finite dimensional Hilbert space \mathbb{C}^N generates a norm continuous semigroup through Eq. (3.100), see Eq. (B.11).

if and only if it can be written in the form

$$L\omega = -i[H, \omega] + \sum_{\alpha=1}^{N^2-1} \gamma_{\alpha} \left(\sigma_{\alpha} \omega \sigma_{\alpha}^{\dagger} - \frac{1}{2} \left\{ \sigma_{\alpha}^{\dagger} \sigma_{\alpha}, \omega \right\} \right) \quad \omega \in \mathcal{L}(\mathbb{C}^N), \quad (3.101)$$

with $\gamma_{\alpha} \geq 0$, $H = H^{\dagger}$, $\sigma_{\alpha} \in \mathcal{L}(\mathbb{C}^N)$.

The theorem extends to infinite dimensional Hilbert spaces [15] if the one-parameter semigroup $\{\Lambda(t, 0)\}_{t \geq 0}$ is norm continuous. As stated in Appendix B this corresponds to a bounded generator⁸.

We do not give here the full proof of the theorem, but let us make the following remarks. From the analysis of the previous section, it is clear that the trace and hermiticity preservation implies that the generator L of the semigroup in Eq. (3.100) has to be as in Eq. (3.101), but without fixing any constraint on the sign of the coefficients γ_{α} , see Eqs. (3.35) and (3.37). Then, taking into account the theorem by Kossakowski in Appendix B and by means of a proper choice of mutually orthogonal projectors, one can see that the coefficients γ_{α} are positive if the linear map $L \otimes \mathbb{1}$ satisfies the conditions in Eqs. (B.9) and (B.10), thus generating a positive semigroup. Indeed, $L \otimes \mathbb{1}$ generates the semigroup $\{\Lambda(t, 0) \otimes \mathbb{1}\}_{t \geq 0}$, so that the positivity of the coefficients γ_{α} does correspond to the complete positivity of the maps $\Lambda(t, 0)$, rather than to their positivity. On the other hand, the complete positivity of the map $\Lambda(t, 0)$ in Eq. (3.100) for L as in Eq. (3.101) can be shown as follows. Let us decompose L as $L = B + C$, with

$$\begin{aligned} B\omega &= -i[H, \omega] - \frac{1}{2} \sum_{\alpha} \gamma_{\alpha} \left\{ \sigma_{\alpha}^{\dagger} \sigma_{\alpha}, \omega \right\} = -i \left(H_{\text{eff}} \omega - \omega H_{\text{eff}}^{\dagger} \right) \\ C\omega &= \sum_{\alpha} \gamma_{\alpha} \sigma_{\alpha} \omega \sigma_{\alpha}^{\dagger}, \end{aligned} \quad (3.102)$$

where we introduced an effective non-hermitian Hamiltonian $H_{\text{eff}} = H - \frac{i}{2} \sum_{\alpha} \sigma_{\alpha}^{\dagger} \sigma_{\alpha}$ and a completely positive map C . Therefore, introducing $R(t) = e^{Bt}$, that is

$$R(t)\omega = e^{Bt}\omega = e^{-iH_{\text{eff}}t} \omega e^{iH_{\text{eff}}^{\dagger}t}, \quad (3.103)$$

and since $d\Lambda(t, 0)/dt = L\Lambda(t, 0)$, one has

$$\Lambda(t, 0) = R(t) + \int_0^t ds R(t-s) C \Lambda(s, 0) = R(t) + (R \star C \Lambda)(t), \quad (3.104)$$

where the symbol \star indicates the convolution in time. This equation can be iterated, thus yielding a Dyson expansion of the form

$$\Lambda(t, 0) = R(t) + (R \star C R)(t) + (R \star C R \star C R)(t) + \dots \quad (3.105)$$

⁸Indeed, in physical applications this condition is often not satisfied since the Hamiltonian as well as the linear operators σ_{α} can be unbounded. However, all known examples for generators of completely positive quantum dynamical semigroup are in Lindblad form, or can be written in Lindblad form by small modifications.

From Eq. (3.105) one can directly see that the map $\Lambda(t, 0)$ is completely positive, because such are by construction $R(t)$ as well as C , and complete positivity is preserved under addition and convolution.

Note that the generator L does not uniquely fix the operators H and σ_α . In fact, the generator L is invariant under a unitary transformation of the set of operators

$$\sqrt{\gamma_\alpha}\sigma_\alpha \mapsto \sqrt{\tilde{\gamma}_\alpha}\tilde{\sigma}_\alpha = \sum_{\beta=1}^{N^2-1} u_{\alpha\beta}\sqrt{\gamma_\beta}\sigma_\beta, \quad (3.106)$$

with $u_{\alpha\beta}$ entries of a $N^2 - 1 \times N^2 - 1$ unitary matrix, and under inhomogeneous transformations

$$\begin{aligned} \sigma_\alpha &\mapsto \tilde{\sigma}_\alpha = \sigma_\alpha + a_\alpha \\ H &\mapsto \tilde{H} = H + \frac{1}{2i} \sum_{\alpha} \gamma_\alpha \left(a_\alpha^* \sigma_\alpha - a_\alpha \sigma_\alpha^\dagger \right) + b, \end{aligned} \quad (3.107)$$

where a_α are complex numbers and b is real. The diagonal form obtained by diagonalizing the coefficient matrix in Eq. (3.35) is the canonical form of the generator.

By virtue of Eqs. (3.100) and (3.101), the master equation corresponding to the one-parameter semigroup $\{\Lambda(t, 0)\}_{t \geq 0}$ is

$$\frac{d}{dt}\rho(t) = L\rho(t) = -i[H, \rho(t)] + \sum_{\alpha=1}^{N^2-1} \gamma_\alpha \left(\sigma_\alpha \rho(t) \sigma_\alpha^\dagger - \frac{1}{2} \left\{ \sigma_\alpha^\dagger \sigma_\alpha, \rho(t) \right\} \right), \quad (3.108)$$

with $\gamma_\alpha \geq 0$, $H = H^\dagger$, and $\sigma_\alpha \in \mathcal{L}(\mathbb{C}^N)$. This is called *Gorini-Kossakowski-Sudarshan-Lindblad equation*, or often simply *Lindblad equation* and the linear operators σ_α are usually called *Lindblad operators*. The formal solution of the Lindblad equation can be written by means of Eq. (3.105) as

$$\rho(t) = \Lambda(t, 0)\rho(0) = R(t)\rho(0) + \sum_{k=1}^{\infty} \int_0^t dt_k \dots \int_0^{t_k} dt_1 R(t-t_k)CR(t_k-t_{k-1}) \dots CR(t_1)\rho(0). \quad (3.109)$$

From a physical point of view, indeed the crucial problem is to determine under which conditions an open-system dynamics can be actually described by means of a semigroup. Generally, this problem is more conveniently faced by working with the master equation, trying to introduce physically motivated approximations which lead from the Hamiltonian dynamics of the total system to a master equation in the Lindblad form, see for example [1, 82, 46]. The typical assumption underlying such a microscopic derivation of a semigroup dynamics is that the environmental excitations due to the interaction with the open system decay on a time scale which is negligible with respect to the time scale characterizing the evolution of the open system. Being τ_S the relaxation time of the open system and τ_E the time scale over which the environmental correlation functions decay, this assumption, known as *Markov condition*, is expressed as

$$\tau_E \ll \tau_S. \quad (3.110)$$

If Eq. (3.110) is satisfied, one can describe the evolution of the open system on a coarse-grained time scale such that the environmental excitations decay over times which are not resolved. The environment quickly forgets any information coming from the open system via the interaction, so that on a proper coarse-grained time scale the memory effects in the evolution of the open system can be safely neglected: the influence that the open system has on the environment cannot affect the open system back again⁹. It is then clear the analogy with classical Markovian processes, which are, naively speaking, the stochastic processes without memory. The precise definitions of both classical Markovian stochastic processes and quantum Markovian dynamics are presented in the next chapter, together with a deeper analysis of the connection between them.

Let us note that the Markov condition in Eq. (3.110) is usually not sufficient in order to guarantee that the reduced dynamics can be described by means of a semigroup. One generally needs for further approximations, that ultimately depend on the specific model under investigation. An explicit example for the dynamics of a massive particle interacting with a low density background gas will be given in Chapter 6. Nevertheless, there are mathematically well-defined limiting procedures that can be applied to whole classes of reduced dynamics, whenever some general conditions on environmental correlation functions are satisfied; namely, the weak-coupling limit [83, 84] and the singular-coupling limit [85, 86].

3.3.2 Time-dependent Lindblad equation

A direct generalization of the Lindblad equation is obtained if we allow the Lindblad operators as well as the coefficients γ_α in Eq. (3.108) to be time dependent, provided the latter always stays positive. Consider thus the master equation

$$\frac{d}{dt}\rho(t) = L(t)\rho(t) = -i[H(t), \rho(t)] + \sum_{\alpha=1}^{N^2-1} \gamma_\alpha(t) \left(\sigma_\alpha(t)\rho(t)\sigma_\alpha^\dagger(t) - \frac{1}{2} \left\{ \sigma_\alpha^\dagger(t)\sigma_\alpha(t), \rho(t) \right\} \right), \quad (3.111)$$

with $\gamma_\alpha(t) \geq 0$, $H(t) = H^\dagger(t)$, and $\sigma_\alpha(t) \in \mathcal{L}(\mathbb{C}^N)$ for any $t \geq 0$. We will use the name *time-dependent Lindblad equation* for time-local master equations of the form as in Eq. (3.111), with positive coefficients $\gamma_\alpha(t)$. Recall that any time-local master equation $d\rho(t)/dt = K_{\text{TCL}}(t)\rho(t)$ can be written by relaxing the request that $\gamma_\alpha(t) \geq 0$, see Sec. (3.1) and in particular Eq. (3.41). By performing a Dyson expansion totally analogous to that of the previous paragraph, one can see that the dynamical map corresponding to Eq. (3.111),

$$\Lambda(t, 0) = T_{\leftarrow} \exp \left[\int_0^t d\tau L(\tau) \right], \quad (3.112)$$

is completely positive. Explicitly, let $L(t)$ be decomposed as $L(t) = B(t) + C(t)$, with

$$\begin{aligned} B(t)\omega &= -i[H(t), \omega] - \frac{1}{2} \sum_{\alpha} \gamma_\alpha(t) \left\{ \sigma_\alpha^\dagger(t)\sigma_\alpha(t), \omega \right\} \\ C(t)\omega &= \sum_{\alpha} \gamma_\alpha(t) \sigma_\alpha(t)\omega\sigma_\alpha^\dagger(t), \end{aligned} \quad (3.113)$$

⁹In Appendix E it is shown how this concept can be formulated more rigorously by means of trace distance.

and let $R(t, s)$ be the solution of the equation $dR(t, s)/dt = B(t)R(t, s)$, with $R(t, t) = \mathbb{1}$ and $t \geq s \geq 0$, i.e.

$$R(t, s) = T_{\leftarrow} \exp \left[\int_s^t d\tau B(\tau) \right]. \quad (3.114)$$

One has then the Dyson expansion

$$\Lambda(t, 0) = R(t, 0) + \sum_{k=1}^{\infty} \int_0^t dt_k \dots \int_0^{t_2} dt_1 R(t, t_k) C(t_k) R(t_k, t_{k-1}) \dots C(t_1) R(t_1, 0). \quad (3.115)$$

Indeed, $\Lambda(t, 0)$ is completely positive since such are by construction both $B(t)$ and $C(t)$. Note that the positivity of the coefficients $\gamma_{\alpha}(t)$ is crucial for the complete positivity of $C(t)$.

One-parameter families of dynamical maps generated by time-dependent Lindblad equations have the remarkable property to be *CP-divisible* (CP standing for completely positive). A one-parameter family of dynamical maps $\{\Lambda(t, 0)\}_{t \geq 0}$ is defined to be CP-divisible if for any $t \geq s \geq 0$ the CPT map $\Lambda(t, 0)$ can be written as the composition of two CPT maps $\Lambda(t, s)$ and $\Lambda(s, 0)$:

$$\Lambda(t, 0) = \Lambda(t, s) \Lambda(s, 0). \quad (3.116)$$

Note that at variance with [87] focusing on quantum channels, the notion of divisibility considered here refers to families of time-dependent dynamical maps. In particular, Eq. (3.116) is satisfied for $\Lambda(t, 0)$ as in Eq. (3.112) by virtue of the map

$$\Lambda(t, s) = T_{\leftarrow} \exp \left[\int_s^t d\tau L(\tau) \right], \quad (3.117)$$

which is completely positive because of the positivity of the coefficients $\gamma_{\alpha}(t)$. We have seen that a time-dependent Lindblad equation yields a CP-divisible evolution. Under proper conditions, also the converse statement is true. In fact, one can prove [21] that, if the one-parameter family of dynamical maps $\{\Lambda(t, 0)\}_{t \geq 0}$ is CP-divisible according to Eq. (3.116) with a unique map $\Lambda(t, s)$ which depends smoothly enough on $t - s$, then the evolution of the state $\rho(t)$ is described by a time-dependent Lindblad equation.

We want to emphasize the following fact, which will play a basic role in the analysis performed in the next chapter. Given a generic one-parameter family of dynamical maps $\{\Lambda(t, 0)\}_{t \geq 0}$ one can always define a two-parameters family of linear maps through

$$\Lambda(t, s) = \Lambda(t, 0) \Lambda^{-1}(s, 0) \quad t \geq s \geq 0 \quad (3.118)$$

for those times s where the inverse map $\Lambda^{-1}(s, 0)$ exists. For these times, Eq. (3.118) is equivalent to Eq. (3.116), but the crucial point is that, in general, the maps $\Lambda(t, s)$ defined as in Eq. (3.118) are *not* completely positive. Consider a family of dynamical maps determined through Eq. (3.26) by a time-local generator $K_{\text{TCL}}(t)$ as in Eq. (3.45). Then one can define a linear map $\Lambda(t, s)$ satisfying Eq. (3.118) as

$$\Lambda(t, s) = T_{\leftarrow} \exp \left[\int_s^t d\tau K_{\text{TCL}}(\tau) \right] \quad (3.119)$$

[compare with Eq. (3.117)], but $\Lambda(t, s)$ is not completely positive if its coefficients $k_\alpha(t)$ are not positive. The linear maps $\Lambda(t, s)$ defined in Eq. (3.118), usually called *transition maps* or *propagators*, are generally not even positive, but, by construction, they map states at time s ¹⁰ to states at time t , since Eq. (3.116) implies $\rho(t) = \Lambda(t, 0)\rho(0) = \Lambda(t, s)\rho(s)$.

Finally, let us make two more remarks. First, if the propagators $\Lambda(t, s)$ only depend on the difference $t - s$ between the two time variables, the property of CP-divisibility in Eq. (3.116) reduces to the semigroup property for the family of completely positive maps $\{\Lambda(t, 0)\}_{t \geq 0}$, see Eq. (3.99)

$$\Lambda(t + s) = \Lambda(t, 0)\Lambda(s, 0) \quad t, s \geq 0. \quad (3.120)$$

Indeed, this is the case of a time-homogeneous master equations, that is the time-local generator $L(t)$ does not depend on time and so the Lindblad equation presented in the previous paragraph is recovered. One can then see CP-divisibility as a generalization of the semigroup property to the time inhomogeneous case and then the evolutions satisfying time-dependent Lindblad equations are often referred to as *time-inhomogeneous (or time-dependent) Markovian* dynamics. However, we will see in the next chapter how the relation with classical inhomogeneous Markovian processes is quite subtle.

Then, from Secs. (3.1) and (3.2) it should be not surprising that one can find CP-divisible one-parameter families of dynamical maps as solutions of integrodifferential master equations. The latter can be in fact equivalent to time-local master equations with positive coefficients $\gamma_\alpha(t)$. In the next chapter we will give some physically relevant examples, see e.g. Eqs. (4.72) and (4.79) and the discussion after Eq. (4.83).

3.3.3 Time-local master equations and complete positivity

Let us come back to the expression of a time-local master equation which is obtained by relaxing the condition $\gamma_\alpha(t) \geq 0$ in Eq. (3.111), see Eq. (3.45). The problem of establishing when complete positivity of the evolution is guaranteed becomes then much more involved. As already remarked, given a generic time-local master equation one cannot say with full generality when it provides a well-defined time evolution. In this paragraph, we want to show, by means of a simple example, some of the difficulties which are met in dealing with this problem.

Consider a time-local master equation for a two-level system, with

$$\begin{aligned} K_{\text{TCL}}(t)\omega &= ih(t) [\sigma_+\sigma_-, \omega] + \gamma_+(t)(\sigma_+\omega\sigma_- - \frac{1}{2} \{\sigma_-\sigma_+, \omega\}) \\ &+ \gamma_-(t)(\sigma_-\omega\sigma_+ - \frac{1}{2} \{\sigma_+\sigma_-, \omega\}) + \gamma_z(t)(\sigma_z\omega\sigma_z - \rho(t)). \end{aligned} \quad (3.121)$$

Note that this time-local generator has the same operator structure as that presented in Sec. (3.2), however we are not here specifying any underlying microscopic model, so that the coefficients $h(t)$ and $\gamma_\alpha(t)$, with $\alpha = +, -, z$, are totally generic. The analysis of complete positivity starting

¹⁰By this expression we mean those states $\rho(s)$ which can be written as $\rho(s) = \Lambda(s, 0)\rho(0)$ for some $\rho(0)$, i.e. those states which belong to the image of the set of states under $\Lambda(s, 0)$.

from a more general time-local master equation for a two-level system is reported in [88]. The matrix of coefficients $K_{\text{TCL}}(t)$ corresponding to the time-local generator $K_{\text{TCL}}(t)$ in Eq. (3.121) can be expressed by means of the representation of linear maps given by Eqs. (2.41) and (2.42) as

$$K_{\text{TCL}}(t) = \begin{pmatrix} 0 & 0 & 0 & 0 \\ 0 & -\gamma(t) & h(t) & 0 \\ 0 & -h(t) & -\gamma(t) & 0 \\ \gamma_+(t) - \gamma_-(t) & 0 & 0 & -\gamma_+(t) - \gamma_-(t) \end{pmatrix}, \quad (3.122)$$

where we introduced

$$\gamma(t) \equiv \frac{1}{2}(\gamma_+(t) + \gamma_-(t)) + 2\gamma_z(t). \quad (3.123)$$

It is easy to see that the matrix

$$\Lambda(t, 0) = \begin{pmatrix} 1 & 0 & 0 & 0 \\ 0 & B(t) & C(t) & 0 \\ 0 & -C(t) & B(t) & 0 \\ A(t) & 0 & 0 & D(t) \end{pmatrix}, \quad (3.124)$$

with

$$\begin{aligned} A(t) &= D(t) \int_0^t d\tau D^{-1}(\tau)(\gamma_+(\tau) - \gamma_-(\tau)) \\ B(t) &= e^{-\int_0^t d\tau \gamma(\tau)} \cos\left(\int_0^t d\tau h(\tau)\right) \\ C(t) &= e^{-\int_0^t d\tau \gamma(\tau)} \sin\left(\int_0^t d\tau h(\tau)\right) \\ D(t) &= e^{-\int_0^t d\tau (\gamma_+(\tau) + \gamma_-(\tau))} \end{aligned} \quad (3.125)$$

satisfies $d\Lambda/dt \Lambda^{-1}(t) = K_{\text{TCL}}(t)$ with $\Lambda(0) = \mathbb{1}$. That is, the linear map $\Lambda(t, 0)$ with matrix representation as in Eqs. (3.124) and (3.125) is the evolution map corresponding to the time-local master equation in Eq. (3.121), see Sec. (3.1) and in particular the discussion of Eq. (3.19). The most direct way in order to check the complete positivity of the linear map $\Lambda(t, 0)$ is to calculate the related Choi matrix, see Eq. (2.66). For $\Lambda(t, 0)$ as in Eq. (3.124), the Choi matrix is given by

$$\Lambda_{\text{Choi}}(t) = \frac{1}{2} \begin{pmatrix} 1 + A(t) + D(t) & 0 & 0 & 2(B(t) + iC(t)) \\ 0 & 1 - A(t) - D(t) & 0 & 0 \\ 0 & 0 & 1 + A(t) - D(t) & 0 \\ 2(B(t) - iC(t)) & 0 & 0 & 1 - A(t) + D(t) \end{pmatrix}. \quad (3.126)$$

The linear map $\Lambda(t, 0)$ is completely positive if and only if its Choi matrix is positive definite, that is if and only if the eigenvalues of the matrix in Eq (3.126) are positive. By using Eq. (3.125), one can see that this is equivalent to the following conditions

$$\begin{aligned} 1 + D(t) &\geq \sqrt{\left(D(t) \int_0^t d\tau D^{-1}(\tau)(\gamma_+(\tau) - \gamma_-(\tau))\right)^2 + 4e^{-2\int_0^t d\tau \gamma(\tau)}} \\ 1 - D(t) &\geq D(t) \left| \int_0^t d\tau D^{-1}(\tau)(\gamma_+(\tau) - \gamma_-(\tau)) \right|. \end{aligned} \quad (3.127)$$

Note that, for this specific situation, the Hamiltonian part of the master equation does not affect the complete positivity of $\Lambda(t, 0)$. For simplicity, let us focus on the case where the sum $\gamma_+(t) + \gamma_-(t)$ equals a positive constant $c \geq 0$,

$$\gamma_+(t) + \gamma_-(t) = c \geq 0, \quad (3.128)$$

and $\gamma_z(t)$ is constant and positive as well. Then, one can see that a necessary and sufficient condition for Eq. (3.127) to be satisfied is

$$\int_0^t d\tau e^{c\tau} \gamma_-(\tau) \in [0, e^{ct} - 1] \quad \forall t. \quad (3.129)$$

This condition can be read by saying that "on average" the coefficient $\gamma_-(t)$ is between 0 and c , so that "on average" both $\gamma_-(t)$ and $\gamma_+(t)$ are positive. Consider now a function $f(t)$ such that¹¹

$$0 \leq \int_0^t d\tau e^{c\tau} f(\tau) \leq e^{ct} - 1$$

$$\int_0^t d\tau e^{2c\tau} f(\tau) \geq \frac{e^{2ct} - 1}{2}, \quad (3.130)$$

and two time-local generators $K_{\text{TCL}}^{(1)}(t) = K_{\text{TCL}}^{(2)}(t)$ as in Eq. (3.121), with coefficients $\gamma_+(t)$ and $\gamma_-(t)$ satisfying Eq. (3.128) and $\gamma_z(t) = \gamma_z \geq 0$. Setting $\gamma_-(t) = f(t)$, we then have a simple example of two time-local generators, $K_{\text{TCL}}^{(1)}(t)$ and $K_{\text{TCL}}^{(2)}(t)$, which individually lead to well-defined completely positive dynamics, but whose sum $K_{\text{TCL}}^{(1)}(t) + K_{\text{TCL}}^{(2)}(t)$ represents a time-local generator that does not preserve complete positivity.

We have thus seen how the set of time-local generators that provide completely positive dynamical maps is not closed under addition. This is a crucial difference with respect to the (time-dependent) Lindblad generators, which can be safely summed by virtue of the positive coefficients. Indeed, this is of great relevance also for a phenomenological approach to the characterization of open-systems dynamics. Given a time-local master equation which yields a well-defined evolution, there is not a simple way in order to include other operator terms that describe different dissipative effects on the open system. Even if the individual terms do guarantee the complete positivity, the overall master equation can be ill-defined. On the same footing one cannot safely remove any term from a well-defined time-local generator since, in general, the presence of each term is crucial for preserving complete positivity of the time evolution.

Finally, let us mention that some general results on the preservation of complete positivity can be derived for time-local generators which commute at different times, see Sec. (3.1.2) and the references therein. In this case the chronological time-ordering operator in Eq. (3.26) simplifies, so that the dynamical map $\Lambda(t, 0)$ is simply given by

$$\Lambda(t, 0) = \exp \left[\int_0^t d\tau K_{\text{TCL}}(\tau) \right]. \quad (3.131)$$

¹¹An example is given by the translated gaussian $a + e^{(t-t_0)^2/\sigma^2}/b$, for a proper choice of a, b, t_0 and σ .

It is then clear that if $\int_0^t d\tau K_{\text{TCL}}(\tau)$ has a Lindblad structure for any $t \geq 0$, then $\Lambda(t, 0)$ is completely positive. Take for example the case of a time-local generator of the form $K_{\text{TCL}}(t) = \sum_{\alpha} k_{\alpha}(t)K_{\alpha}$, with $[K_{\alpha}, K_{\beta}] = 0$. Then

$$\int_0^t d\tau k_{\alpha}(\tau) \geq 0 \quad \forall \alpha \quad (3.132)$$

implies that $\Lambda(t, 0)$ as in Eq. (3.131) is completely positive. Note that in general, Eq. (3.132) is not a sufficient condition for the complete positivity of the corresponding evolution, as one can easily see by means of the example previously discussed.

3.3.4 From Lindblad structure to completely positive integrodifferential master equations

In the previous paragraph, we have shown some of the problems which are met when trying to determine whether a generic time-local master equation guarantees a completely positive evolution. Indeed, fully analogous considerations hold for integrodifferential master equations. Moreover, as one can see for example from the analysis of Sec. (3.2), well-defined integrodifferential master equations cannot be generally obtained simply by taking the convolution of a Lindblad generator with a single integral kernel [89]. In this paragraph, we generalize the Dyson expansion described in Secs. (3.3.1) and (3.3.2) to integrodifferential master equations. This allows us to present a class of non-local master equations that do yield well-defined time evolutions.

Consider an integrodifferential master equation as in Eq. (3.46), with generic linear operators $\sigma_{\alpha}(t)$ and real coefficients $r_{\alpha}(t)$, while $H^{\dagger}(t) = H(t)$. Indeed, if the memory kernel is proportional to a δ -function through the relation $K_{\text{NZ}}(t) = 2\delta(t)L$, one recovers the Lindblad master equation. We can now proceed exactly as done for the Lindblad generator and for its local time dependent generalization, in order to obtain a Dyson expansion of the corresponding dynamical map $\Lambda(t, 0)$. Following also [90, 68, 91], let us decompose the memory kernel as $K_{\text{NZ}}(t) = B(t) + C(t)$, with $B(t)$ and $C(t)$ as in Eq. (3.113), where $\gamma_{\alpha}(t)$ is replaced by $r_{\alpha}(t)$. Let $\widehat{R}(t)$ be the solution of $dR(t)/dt = \int_0^t d\tau B(t - \tau)R(\tau)$, with $R(0) = \mathbb{1}$, that is, introducing the Laplace transform as in Eq. (3.20),

$$\widehat{R}(u) = \frac{1}{u - \widehat{B}(u)}. \quad (3.133)$$

Then, since the Laplace transform $\widehat{\Lambda}(u)$ of $\Lambda(t, 0)$ satisfies Eq. (3.27), one has

$$\widehat{\Lambda}(u) = \widehat{R}(u) + \widehat{R}(u)\widehat{C}(u)\widehat{\Lambda}(u) \quad (3.134)$$

or, going back to the time domain,

$$\Lambda(t, 0) = R(t) + (R \star C \star \Lambda)(t). \quad (3.135)$$

This leads to the Dyson expansion

$$\Lambda(t, 0) = R(t) + (R \star C \star R)(t) + (R \star C \star R \star C \star R) + \dots \quad (3.136)$$

This formal expansion tells us that if $R(t)$ and $C(t)$ are completely positive, then so is $\Lambda(t, 0)$. Furthermore, the same holds under the weaker condition that $R(t)$ and $(R \star C)(t)$ are completely positive. This means that one can have completely positive maps $\Lambda(t, 0)$ even if the coefficients $r_\alpha(t)$ in the memory kernel take on negative values.

To be explicit, let us consider the case in which $B(t)$ can be diagonalized in a fixed basis, and in particular it holds

$$\begin{aligned} H(t) &= \sum_k \epsilon_k(t) |k\rangle \langle k| \\ \sum_\alpha r_\alpha(t) \sigma_\alpha^\dagger(t) \sigma_\alpha(t) &= \sum_k b_k(t) |k\rangle \langle k|. \end{aligned} \quad (3.137)$$

Moreover, take $r_\alpha(t) \geq 0$, so that $C(t)$ is a completely positive map and the eigenvalues $b_k(t)$ must be positive as well. We can now write $R(t)$ in terms of matrices of functions

$$R(t)\omega = \sum_{kl} g_{kl}(t) |k\rangle \langle k| \omega |l\rangle \langle l|, \quad (3.138)$$

solutions of

$$\frac{d}{dt} g_{kl}(t) = - \int_0^t d\tau (z_k(\tau) + z_l^*(\tau)) g_{kl}(t - \tau) \quad z_k(\tau) = \frac{1}{2} b_k(\tau) + i\epsilon_k(\tau), \quad (3.139)$$

with initial condition $g_{kl}(0) = 1$. The linear map $R(t)$ can be written in Kraus form provided the matrices $G(t)$ with entries $g_{kl}(t)$ are positive-definite for any $t \geq 0$, i.e.

$$G(t) = (g_{kl}(t)) \geq 0 \quad \forall t \geq 0. \quad (3.140)$$

Thus, Eq. (3.140) is a sufficient condition for integrodifferential equations satisfying Eq. (3.137) to yield a completely positive evolution. In the next chapter we will see how this condition is a natural extension of the request that the diagonal elements $g_{kk}(t)$ are the survival probabilities of a classical semi-Markov process. More specifically, we will see how integrodifferential equations satisfying Eqs. (3.137) and (3.140) are within a class of master equations that represent a non-local generalization of the Lindblad structure and that are called *quantum semi-Markov* master equations [92, 93], since the dynamics they describe can be thought as the quantum counterpart of classical semi-Markov processes.

Finally, let us introduce the specific case in which $\epsilon_k(t) = 0$, $b_k(t) = b(t) \forall k$, and in particular the memory kernel reduces to

$$K_{\text{NZ}}(t)\omega = b(t) (\mathcal{E}\omega - \omega), \quad (3.141)$$

with \mathcal{E} CPT map. This kind of master equation was introduced in [94] and it will be widely used in the next chapter, where its stochastic interpretation is clarified, as well.

Chapter 4

Non-Markovianity in classical stochastic processes and in quantum dynamics

In the previous chapter, we introduced the concept of Markovianity in connection with quantum dynamical semigroups and their generalization represented by CP-divisible one-parameter families of dynamical maps. The evolution of an open system can be actually described by these kinds of dynamical maps only if one can adopt a series of simplifying assumptions, such as weak coupling and separation of time scales between system and environment, that are not justified on many concrete physical systems. Generally speaking, we can say that whenever memory effects in the dynamics of an open system have to be taken into account, a non-Markovian characterization of the reduced dynamics is required. It is then not surprising that in the last years the theoretical study of non-Markovian dynamics has experienced a great revival, leading to important improvements and to a deeper understanding of quite a few issues in the theory of open quantum systems (see e.g. [95, 96, 97, 92, 69, 98] and references therein).

Nevertheless, contrary to what happens for classical stochastic processes, the very notion of non-Markovianity in the quantum case still has to be cleared up. The well-established definition for non-Markovianity of a classical stochastic process represents a condition on the hierarchy of the conditional probability distributions and then it cannot be directly transferred to the dynamics of open quantum systems, which is expressed in terms of the reduced statistical operator $\rho(t)$. In order to characterize and actually define Markovianity and non-Markovianity for quantum dynamics two approaches have been recently introduced. One is based on the behavior in time of the solution $\rho(t)$, allowing the initial condition to vary over the possible set of states. This is the approach elaborated in [19, 21], relying on a suitable notion of distinguishability of quantum states [99], an approach which captures the idea of information flow between system and environment, as discussed in Appendix E. The other approach is based on the assumption that the family of dynamical maps $\{\Lambda(t, 0)\}_{t \geq 0}$ is known and it identifies Markovianity with the property of CP-divisibility, see Sec. (3.3.2), which is essentially the path followed in [20]. Both these approaches have also led to the introduction of measures of non-Markovianity, in order to quantify the degree

of non-Markovianity of a given dynamics.

In the present chapter, we focus on the connection between the very definition of non-Markovian process used in classical probability theory and the criteria for characterizing non-Markovianity in the dynamics of open quantum systems, also showing how these criteria have natural counterpart in the classical setting if the evolution of one-point probability densities is taken into account. Our results clearly demonstrate several fundamental distinctions between the classical and the quantum notion of non-Markovianity, as well as between the various quantum measures for non-Markovianity. The material presented is for the most part contained in [31].

In the first section, we recall the precise definition of classical Markovian stochastic process, together with the Chapman-Kolmogorov equation for its conditional probabilities. We introduce the classical dynamical maps, which are the analogous of the dynamical maps presented in Sec. (2.2) for the quantum setting. By means of them, we analyze how the non-Markovianity of a process is reflected into the behavior of its one-point probability density, which naturally leads to criteria for the characterization of non-Markovian behavior in the dynamics. These are based, respectively, on the possibility to connect the probability vectors giving the state of the system at different times through positive transition matrices, namely P-divisibility, and on the behavior of solutions corresponding to different initial states with respect to the Kolmogorov distance. These criteria represent the classical counterpart of the two above-mentioned approaches to assess the non-Markovianity of a quantum time evolution. The relation between the property of P-divisibility and the Chapman-Kolmogorov equation is widely discussed and it is explicitly shown that they are not equivalent. Despite the abstract framework, the whole presentation is built with reference to explicit examples. These examples find their common root in being related to realizations of a class of non-Markovian processes for which an explicit characterization is available, namely semi-Markov processes. This is indeed an exceptional situation, since the characterization of non-Markovian processes, and even more of classes of them, is actually in the general case a formidable task.

In the second section, we perform a similar analysis in the quantum setting. We consider a class of dynamics that can be naturally connected to classical semi-Markov processes, for which we will use the term *quantum semi-Markov dynamics* [92, 93], see also Sec. (3.3.4). These dynamics still allow for an exact determination of their divisibility properties and of their quantum measure of non-Markovianity according to the recent proposals. In particular we provide exact expressions for the value of these measures, thus allowing for their explicit comparison. Indeed, the Markovianity or non-Markovianity of a given dynamics has to be understood as a property of the map or equivalently of the time evolved states, not of the equations admitting such states as solutions. Of course, since in a concrete physical setting one is faced with the equations of motion rather than with their general solution, it is of great interest to assess possible links between the equations themselves and the Markovian or non-Markovian behavior of their solutions. This is explicitly achieved by means of some relevant examples.

4.1 Classical non-Markov processes

4.1.1 Markov processes

Let us now recall what is the very definition of Markovian process in the classical probabilistic setting. Indeed the analysis of classical processes is a natural starting point, also adopted in [48, 91, 100, 46, 101]. Suppose we are considering a stochastic process taking values in a denumerable set $\{x_k\}_{k \in \mathbb{N}}$. The process is said to be Markovian if the conditional probabilities satisfy

$$p_{1|n}(x_n, t_n | x_{n-1}, t_{n-1}; \dots; x_0, t_0) = p_{1|1}(x_n, t_n | x_{n-1}, t_{n-1}) \quad (4.1)$$

with $t_n \geq t_{n-1} \geq \dots \geq t_1 \geq t_0$, i.e. the probability that the random variable assumes the value x_n at time t_n , under the condition that it has assumed given values x_k at previous times t_k , actually only depends on the last assumed value, and not on previous ones. In this sense the process is said to lack memory. This statement obviously involves all n -times probabilities, so that it immediately appears how the non-Markovianity of the process cannot be assessed by looking at the one-time probabilities only [102, 103]. A general stochastic process is specified if the infinite hierarchy of probability distributions $p_n(x_n, t_n; x_{n-1}, t_{n-1}; \dots; x_0, t_0)$, for any $n = 1, 2, \dots$ and $t_n \geq t_{n-1} \geq \dots \geq t_1 \geq t_0$, is fixed. The peculiar feature of Markov processes is that their entire hierarchy of probability distributions can be reconstructed in terms of the initial probability distribution and the conditional probability $p_{1|1}$. In fact, it is easy to see that the Markovian condition Eq. (4.1) implies

$$p_n(x_n, t_n; x_{n-1}, t_{n-1}; \dots; x_0, t_0) = \prod_{k=1}^n p_{1|1}(x_k, t_k | x_{k-1}, t_{k-1}) p_1(x_0, t_0). \quad (4.2)$$

Moreover, the Markov condition Eq. (4.1) implies that the conditional probability $p_{1|1}$ obeys the following equation:

$$p_{1|1}(x, t | y, s) = \sum_z p_{1|1}(x, t | z, \tau) p_{1|1}(z, \tau | y, s), \quad (4.3)$$

with $t \geq \tau \geq s$, which is the discrete version of the well-known *Chapman-Kolmogorov equation*. It is often useful to consider the differential form of this equation. Let us take into account, in particular, a process such that there is a probability $W(x|y, t)\Delta t$ that the random variable instantaneously jumps from the value y to x within the infinitesimal time interval $[t, t + \Delta t]$, under the condition that it takes the value y at time t . Then one can prove, see e.g. [104, 105, 1], that the Chapman-Kolmogorov equation leads to

$$\frac{\partial}{\partial t} p_{1|1}(x, t | y, s) = \sum_z (W(x|z, t) p_{1|1}(z, t | y, s) - W(z|x, t) p_{1|1}(x, t | y, s)). \quad (4.4)$$

This is the differential Chapman-Kolmogorov equation, often simply referred to as *master equation*. Note that $W(x|y, t) \geq 0$ since these quantities are the transition rates of the different jumps. A completely analogous equation holds for the one-point probability p_1 , i.e.

$$\frac{\partial}{\partial t} p_1(x, t) = \sum_y (W(x|y, t) p_1(y, t) - W(y|x, t) p_1(x, t)). \quad (4.5)$$

This equation, with positive coefficients $W(x|y, t)$, is often referred to as *Pauli master equation*. Nevertheless, it is important to emphasize that the differential Chapman-Kolmogorov equation has to be understood as an equation for the conditional probability $p_{1|1}$, rather than as an equation for p_1 . In fact, a time-evolution equation for the one-point probability distribution is not sufficient in order to define a stochastic Markov process, not even to determine whether the process is Markovian or non-Markovian. We will explicitly see that there are non-Markov processes which do not satisfy the Chapman-Kolmogorov equation¹, but whose one-point probability distribution satisfies the Pauli master equation given by Eq. (4.5).

Let us now consider a finite dimensional classical system, so that the one-point probability distribution at time t is a probability vector $\mathbf{p}(t)$, i.e. its elements, which will be denoted as $p_k(t)$ $k = 1, \dots, N$ with N the dimension of the system, satisfy $p_k(t) \geq 0$ and $\sum_k p_k(t) = 1$ for any $t \geq 0$. In full analogy with the quantum case, see Sec. (2.2), the time evolution of $\mathbf{p}(t)$ can be described by a family of dynamical maps $\{\Lambda(t, 0)\}_{t \geq 0}$ according to

$$\mathbf{p}(t) = \Lambda(t, 0) \mathbf{p}(0). \quad (4.6)$$

It is easy to see that a matrix Λ associates probability vectors to probability vectors if and only if its entries $(\Lambda)_{jk}$ satisfy the following conditions:

$$\begin{aligned} (\Lambda)_{jk} &\geq 0 \quad \forall j, k = 1, \dots, N \\ \sum_{j=1}^N (\Lambda)_{jk} &= 1 \quad \forall k = 1, \dots, N. \end{aligned} \quad (4.7)$$

A matrix which fulfills Eq. (4.7) is regularly called *stochastic matrix*. Moreover, we can introduce the concept of P-divisibility as follows, compare with Sec. (3.3.2). We say that the family of classical dynamical maps $\{\Lambda(t, 0)\}_{t \geq 0}$ is P-divisible provided for any $t \geq s \geq 0$ one can write

$$\Lambda(t, 0) = \Lambda(t, s) \Lambda(s, 0), \quad (4.8)$$

where each of the $\Lambda(t, s)$ is itself a stochastic matrix, and then it sends probability vectors into probability vectors. Once again, this needs not generally be true, even if the map $\Lambda(s, 0)$ is invertible as linear operator, so that one can define the matrix

$$\Lambda(t, s) = \Lambda(t, 0) \Lambda^{-1}(s, 0). \quad (4.9)$$

In fact, Eq. (4.8) is then satisfied, but $\Lambda(t, s)$ is not necessarily a stochastic matrix, see Eq. (3.118) and the related discussion. In any case, the matrices $\Lambda(t, s)$ defined in Eq. (4.9) relate probability vectors at different times according to

$$\mathbf{p}(t) = \Lambda(t, s) \mathbf{p}(s), \quad (4.10)$$

¹Even if the conditional probability $p_{1|1}$ of a given process satisfies the Chapman-Kolmogorov equation, the process is not necessarily Markovian [106, 107]. However, in the following we will focus on a more limited question, namely the different role played by the evolution of, respectively, the one-point probability p_1 and the conditional probability $p_{1|1}$.

and thus they can be called *transition maps* or *propagators*.

Note that we are here only considering the one-point probabilities $\mathbf{p}(t)$, which are certainly not enough to assess Markovianity or non-Markovianity of a process according to the mathematically precise definition used in classical probability theory. If $\mathbf{p}(t)$ denotes the vector giving the one-point probability of a Markov process taking values in a finite space, then one can identify the transition maps $\Lambda(t, s)$ with its conditional probabilities expressed in matrix form, i.e. $(\Lambda(t, s))_{jk} = p_{1|1}(j, t|k, s)$. In this case the Chapman-Kolmogorov equation is equivalent to the requirement of P-divisibility in the sense of Eq. (4.8), which is then satisfied. However, validity of the Chapman-Kolmogorov equation and P-divisibility do not coincide, since in general P-divisibility does not tell anything about the actual conditional probabilities. Indeed, for a given process one might find a stochastic matrix $\Lambda(t, s)$ satisfying Eqs. (4.8) and (4.10) even if the process is non-Markovian; however in this case the matrix is not the conditional probability of the process [108, 109, 110, 111, 112]. Consider for example the case in which $\Lambda(t, s)$ is defined from the family of classical dynamical maps through Eq. (4.9) and it is a stochastic matrix, so that the P-divisibility requirement is satisfied. Indeed Eq. (4.9) warrants independence from the initial probability vector, while, on the contrary, the conditional probability of a non-Markovian process does depend on the initial probability vector [108]. The difference between the transition map $\Lambda(t, s)$ and the conditional probability $p_{1|1}(t|s)$ is then a distinctive feature of non-Markovian processes and it will be explicitly shown for a specific semi-Markov process in Sec. (4.1.4).

Finally, let us note that, given a generic process, the conditional probability with respect to the initial time $p_{1|1}(t|0)$ does not depend on $\mathbf{p}(0)$, so that if the evolution described by $\Lambda(t, 0)$ is defined for any initial condition $\mathbf{p}(0)$, then one can set

$$\Lambda(t, 0) = p_{1|1}(t|0). \quad (4.11)$$

Classical dynamical maps can thus be equivalently seen as conditional probabilities with respect to the initial time.

4.1.2 Semi-Markov processes

We consider now a class of non-Markovian processes allowing for a compact characterization, that is to say semi-Markov processes [113]. Semi-Markov processes generalize Markov processes by combining the theory of Markov chains and of renewal processes [114]. Markov chains are the discrete-time analogous of stochastic Markov processes taking values on a finite or countable set of values. A Markov chain is characterized by the set π_{jk} of probabilities that whenever the process is in state k , it will next be in state j . These probabilities only depend on departure and arrival states and the time spent in each state is immaterial.

On the other hand, a renewal process is a counting process² for which the times between successive events are independent and identically distributed (i.i.d.) random variables. A renewal process is then fixed by the *waiting time distribution* $f(t)$, which is the probability density characterizing

²A counting process is a stochastic process $\{N(t), t \geq 0\}$ representing the total number of events that occur up to time t . More precisely, it is an integer-valued stochastic process such that $N(t) \geq 0$ and if $s < t$, then $N(s) \leq N(t)$. Moreover, for $s < t$, $N(t) - N(s)$ equals the number of events which occur in the interval $(s, t]$.

such i.i.d. random variables. Given that an event occurred at time s , $\int_0^t d\tau f(\tau)$ denotes the probability that the next event will occur no later than time $t + s$. Let us stress that the process starts anew at every step, as indicated by the adjective renewal. The probability $p(n, t)$ that there are n -events up to time t can be iteratively determined by means of the relation

$$p(n, t) = \int_0^t d\tau f(t - \tau)p(n - 1, \tau). \quad (4.12)$$

In Laplace transform this leads to

$$\hat{p}(n, u) = \hat{g}(u)\hat{f}^n(u), \quad (4.13)$$

where $g(t) = p(0, t)$ is the *survival probability*, i.e. the probability that no events occur up to time t , which is naturally given by

$$g(t) = 1 - \int_0^t d\tau f(\tau). \quad (4.14)$$

A special case of renewal processes is represented by the Poisson process, i.e. Markov counting process. This is obtained if the waiting time distribution is an exponential distribution, which is the only distribution possessing the following memoryless property. A random variable X is said to be memoryless if

$$p\{X > s + t | X > t\} = p\{X > s\}. \quad (4.15)$$

Applied to the waiting time distribution of a renewal process, this means that the system has no memory that a certain amount of time has passed since the previous event took place.

Semi-Markov processes combine the features of Markov chains and renewal processes: they describe a system moving between different states in a way such that the random times separating the different transitions as well as the transition probabilities between the different states only depend on departure and arrival states. If one only considers the different states visited by a semi-Markov process a Markov chain is recovered, while if the state space is reduced to a single element one recovers a renewal process. A semi-Markov process is uniquely determined by the *semi-Markov matrix* $Q(t)$, whose entries $q_{jk}(t)$ are the probability densities to make the jump $k \rightarrow j$ in a time t , so that they represent a collection of state-dependent waiting time distributions. If a jump occurs with certainty the following normalization holds:

$$\sum_j \int_0^\infty d\tau q_{jk}(\tau) = 1. \quad (4.16)$$

Analogously, one can introduce a collection of state-dependent survival probabilities

$$g_k(t) = 1 - \sum_j \int_0^t d\tau q_{jk}(\tau). \quad (4.17)$$

In the following we will focus on the case in which the waiting time distribution only depends on the departure state, so that one has the factorization

$$q_{jk}(t) = \pi_{jk}f_k(t), \quad (4.18)$$

where π_{jk} are the transition probabilities of a Markov chain satisfying $\sum_j \pi_{jk} = 1$ and $f_k(t)$ are arbitrary state-dependent waiting time distributions. The corresponding survival probabilities are then given by

$$g_k(t) = 1 - \int_0^t d\tau f_k(\tau). \quad (4.19)$$

Let us emphasize that a semi-Markov process turns out to be Markovian if and only if the waiting time distributions $f_k(t)$ are given by exponential probability distributions, and non-Markovian otherwise [93].

Starting from the central quantities given by the waiting time distributions $q_{jk}(t)$, an equation of motion for the probability conditioned over the initial state $p_{1|1}(j, t|k, 0)$, can be derived [115, 116]. By using the vectorial notation, so that $p_k(t)$ indicates the probability to be in state k at time t , the corresponding equation for the one-point probability distribution can be written as

$$\frac{d}{dt} p_k(t) = \int_0^t d\tau \sum_j (W_{kj}(\tau) p_j(t - \tau) - W_{jk}(\tau) p_k(t - \tau)), \quad (4.20)$$

with

$$W_{jk}(t) = \pi_{jk} b_k(t). \quad (4.21)$$

The $b_k(t)$ are memory functions without a direct physical meaning, but related to waiting time distribution and survival probability according to

$$f_k(t) = \int_0^t d\tau b_k(\tau) g_k(t - \tau) = (b_k \star g_k)(t) \quad (4.22)$$

$$\frac{d}{dt} g_k(t) = - \int_0^t d\tau b_k(\tau) g_k(t - \tau) = -(b_k \star g_k)(t), \quad (4.23)$$

which in Laplace transform are expressed as

$$\hat{b}_k(u) = \frac{\hat{f}_k(u)}{\hat{g}_k(u)} = \frac{u \hat{f}_k(u)}{1 - \hat{f}_k(u)}. \quad (4.24)$$

Note that the functions $b_k(t)$, and then $W_{jk}(t)$ as well, can take on negative values even when obtained from a well-defined semi-Markov process [93].

4.1.3 Examples

In order to construct some explicit examples, let us now assume for the sake of simplicity a two-states system, a state-independent waiting time distribution and the stochastic matrix to be actually bistochastic [117]. The semi-Markov matrix is then determined according to

$$Q(\tau) = \begin{pmatrix} 1 - \pi & \pi \\ \pi & 1 - \pi \end{pmatrix} f(\tau) \equiv \Pi f(\tau) \quad (4.25)$$

with π a positive number between zero and one giving the probability to jump from one site to the other, and $f(\tau)$ an arbitrary waiting time distribution with associated survival probability $g(t)$

as in Eq. (4.14). The dynamical map for such a process can be determined exploiting Eq. (4.20), which for the case at hand is equivalent to

$$\frac{d}{dt}\Lambda(t, 0) = \int_0^t d\tau W(t - \tau) \Lambda(\tau, 0), \quad (4.26)$$

here expressed in matrix form with

$$W(t) = (\Pi - \mathbb{1}) b(t), \quad (4.27)$$

where the memory kernel $b(t)$ relates waiting time distribution and survival probability according to $f(t) = (b \star g)(t)$, see Eq. (4.22). The solution of this equation, with initial condition $\Lambda(0, 0) = \mathbb{1}$, can be easily expressed in Laplace transform as

$$\hat{\Lambda}(u) = \frac{\hat{g}(u)}{\mathbb{1} - \Pi \hat{f}(u)}. \quad (4.28)$$

In particular, for $\pi = 1/2$, so that at each step the system has equal probability to remain in the same site or to change, one has

$$\Lambda(t, 0) = \frac{1}{2} \begin{pmatrix} 1 + g(t) & 1 - g(t) \\ 1 - g(t) & 1 + g(t) \end{pmatrix}. \quad (4.29)$$

Thus, according to Eq. (4.9) we can introduce the transition maps

$$\begin{aligned} \Lambda(t, s) &= \Lambda(t, 0) \Lambda^{-1}(s, 0) \\ &= \frac{1}{2} \begin{pmatrix} 1 + g(t)/g(s) & 1 - g(t)/g(s) \\ 1 - g(t)/g(s) & 1 + g(t)/g(s) \end{pmatrix}, \end{aligned} \quad (4.30)$$

which indeed connect the probability vectors at different times according to Eq. (4.10). Given the fact that for any non vanishing waiting time distribution the survival probability is a strictly positive monotonic decreasing function, the matrices $\Lambda(t, s)$ are well-defined stochastic matrices for any pair of times $t \geq s$, so that the family of classical dynamical maps $\{\Lambda(t, 0)\}_{t \geq 0}$ is always P-divisible, irrespective of the fact that the underlying process is Markovian only for the special choice of an exponential waiting time distribution of the form

$$f(\tau) = \lambda e^{-\lambda\tau}. \quad (4.31)$$

This result implies that the one-point probabilities of the considered non-Markovian semi-Markov process can be equally well obtained from a Markov process with conditional probability $p_{1|1}(t, s)$ given by $\Lambda(t, s)$, whose n -point probabilities can be obtained as in Eq. (4.2) [108]. The latter would however differ from those of the considered semi-Markov process.

As a complementary situation, let us consider the case $\pi = 1$, so that once in a state the system jumps with certainty to the other, thus obtaining as explicit solution of Eq. (4.26) the expression

$$\Lambda(t, 0) = \frac{1}{2} \begin{pmatrix} 1 + q(t) & 1 - q(t) \\ 1 - q(t) & 1 + q(t) \end{pmatrix}, \quad (4.32)$$

and therefore

$$\begin{aligned}\Lambda(t, s) &= \Lambda(t, 0) \Lambda^{-1}(s, 0) \\ &= \frac{1}{2} \begin{pmatrix} 1 + q(t)/q(s) & 1 - q(t)/q(s) \\ 1 - q(t)/q(s) & 1 + q(t)/q(s) \end{pmatrix}.\end{aligned}\quad (4.33)$$

The quantity $q(t)$ appearing in these matrices is the inverse Laplace transform of the function

$$\hat{q}(u) = \frac{1}{u} \frac{1 - \hat{f}(u)}{1 + \hat{f}(u)}.\quad (4.34)$$

Recalling that the probability $p(n, t)$ for n jumps in a time t for a waiting time distribution $f(t)$ is given by Eq. (4.12) and then Eq. (4.13) holds, one has

$$q(t) = \sum_{n=0}^{\infty} p(2n, t) - \sum_{n=0}^{\infty} p(2n+1, t) = p(\text{even}, t) - p(\text{odd}, t).\quad (4.35)$$

The quantity $q(t)$ therefore expresses the difference between the probability to have an even or an odd number of jumps. At variance with the previous situation, the quantity $q(t)$ depending on the waiting time distribution can assume quite different behavior, showing oscillations and going through zero at isolated time points, so that at these time points the transition matrix $\Lambda(t, s)$ is not defined. Moreover due to the non monotonicity of $|q(t)|$ the matrices $\Lambda(t, s)$ cannot always be interpreted as stochastic matrices, since their entries can take on negative values. Of course in the Markovian case, corresponding to Eq. (4.31) and therefore to $q(t) = \exp(-2\lambda t)$, all these features are recovered.

The variety of possible behavior is best clarified by considering explicit expressions for the waiting time distribution $f(t)$ which determines the process once the stochastic matrix Π is given. Quite general expressions of waiting time distribution can be obtained by considering convex mixtures or convolutions of exponential waiting time distributions with equal or different parameters, whose Laplace transform is given by rational functions [118, 119]. To better understand the dynamics generated by the maps Eq. (4.29) and Eq. (4.32) in the following examples note that for $\pi = 1/2$ the matrix Π is idempotent, sending each probability vector to the uniform distribution, while for $\pi = 1$ one has $\Pi^{2n} = \mathbb{1}$, and the action of the bistochastic matrix consists in swapping the two elements of the probability vector.

Convolution of exponential waiting time distributions

The behavior of the quantity $q(t)$ can be explicitly assessed for the case of a waiting time distribution $f(t)$ given by the convolution of two exponential waiting time distributions. Let us first consider the case in which the waiting time distributions share the same parameter λ , so that $f = f * f$ with f as in Eq. (4.31), corresponding to

$$f(t) = \lambda^2 t e^{-\lambda t}\quad (4.36)$$

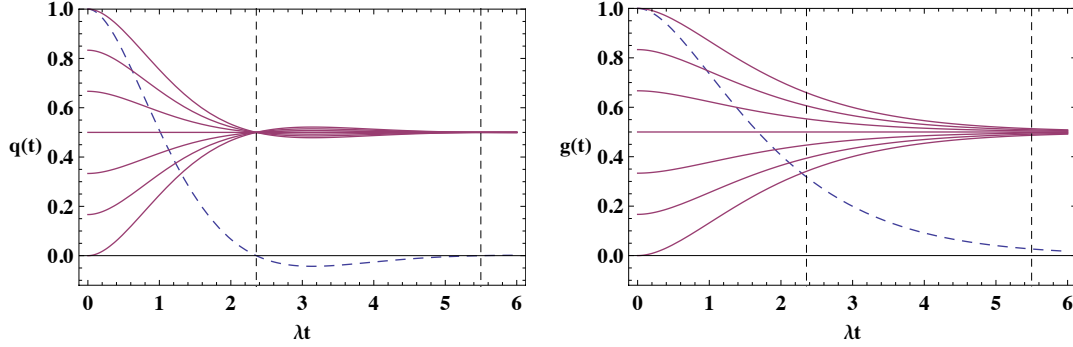

Figure 4.1: (left) Plot of the function q (dashed line) given by Eq. (4.35) as a function of λt for the convolution of two equal exponential waiting time distributions, for the case of a semi-Markov process with $\pi = 1$, together with a few trajectories (continuous lines) for the upper element $w(t)$ of the one-point probability according to Eq. (4.39). The initial data $w(0)$ are uniformly taken between 0 and 1. When $q(t)$ goes through zero the trajectories cross. At these points $|q(t)|$ starts growing, which indicates the failure of P-divisibility of the time evolution as defined in Eq. (4.8). (right) Plot of the function g given by Eq. (4.14) as a function of λt , for the same waiting time distribution, together with a few trajectories, corresponding to a semi-Markov process with $\pi = 1/2$. As it appears despite sharing the same waiting time distribution the trajectories for this semi-Markov process never cross, and P-divisibility holds even if the process is non-Markovian.

and therefore

$$g(t) = (1 + \lambda t) e^{-\lambda t}. \quad (4.37)$$

This is a special case of the Erlang distribution [119], leading to

$$q(t) = e^{-\lambda t} [\cos(\lambda t) + \sin(\lambda t)], \quad (4.38)$$

which oscillates and crosses zero at isolated points, so that the matrices $\Lambda(t, s)$ are not defined at these points and cannot be always interpreted as stochastic matrices, since their entries can become negative. This behavior is exhibited in Fig. (4.1), where the quantity Eq. (4.38) is plotted together with the trajectories of the probability vector with different initial conditions. We also consider the behavior of $g(t)$ and of the trajectories for the same waiting time distribution but a semi-Markov process with stochastic matrix fixed by $\pi = 1/2$. The probability vector is of the form

$$\mathbf{p}(t) = \begin{pmatrix} w(t) \\ 1 - w(t) \end{pmatrix}, \quad (4.39)$$

so that its trajectories are displayed showing $w(t)$, where

$$w(t) = \frac{1}{2} [1 - q(t) + 2q(t)w(0)] \quad (4.40)$$

or

$$w(t) = \frac{1}{2} [1 - g(t) + 2g(t)w(0)] \quad (4.41)$$

in the two cases $\pi = 1$ and $\pi = 1/2$, respectively. Note how for $\pi = 1$ the different trajectories tend to group together and then separate again depending on the behavior of $q(t)$.

A more general situation is given by $f = f_1 * f_2$, where each f_i is of the form Eq. (4.31) with parameter λ_i , so that one has

$$f(t) = 2\frac{p}{s}e^{-\frac{1}{2}st}\frac{1}{\xi}\text{Sinh}\left(\frac{st}{2}\xi\right) \quad (4.42)$$

and correspondingly

$$g(t) = e^{-\frac{1}{2}st}\left[\text{Cosh}\left(\frac{st}{2}\xi\right) + \frac{1}{\xi}\text{Sinh}\left(\frac{st}{2}\xi\right)\right], \quad (4.43)$$

where we have set

$$\begin{aligned} s &= \lambda_1 + \lambda_2 \\ p &= \lambda_1\lambda_2 \\ \xi &= \sqrt{1 - 4\frac{p}{s^2}}. \end{aligned} \quad (4.44)$$

The function $q(t)$ determining the matrices $\Lambda(t, s)$ is now given by

$$q(t) = e^{-\frac{1}{2}st}\left[\text{Cosh}\left(\frac{st}{2}\chi\right) + \frac{1}{\chi}\text{Sinh}\left(\frac{st}{2}\chi\right)\right] \quad (4.45)$$

with

$$\chi = \sqrt{1 - 8\frac{p}{s^2}}. \quad (4.46)$$

The expression given by Eq. (4.45) shows an oscillatory behavior if χ becomes imaginary, for $3 - 2\sqrt{2} \leq \lambda_1/\lambda_2 \leq 1/(3 - 2\sqrt{2})$, while it is a positive monotonic function of t otherwise. The latter situation is considered in Fig. (4.2).

Mixture of exponential waiting time distributions

For the case of a convex mixture of two exponential distributions on the contrary the trajectories never cross, and the matrices $\Lambda(t, s)$ are always well-defined stochastic matrices. Indeed this can be seen from

$$f(t) = \mu f_1(t) + (1 - \mu) f_2(t), \quad (4.47)$$

with $0 \leq \mu \leq 1$, so that

$$g(t) = \mu e^{-\lambda_1 t} + (1 - \mu) e^{-\lambda_2 t} \quad (4.48)$$

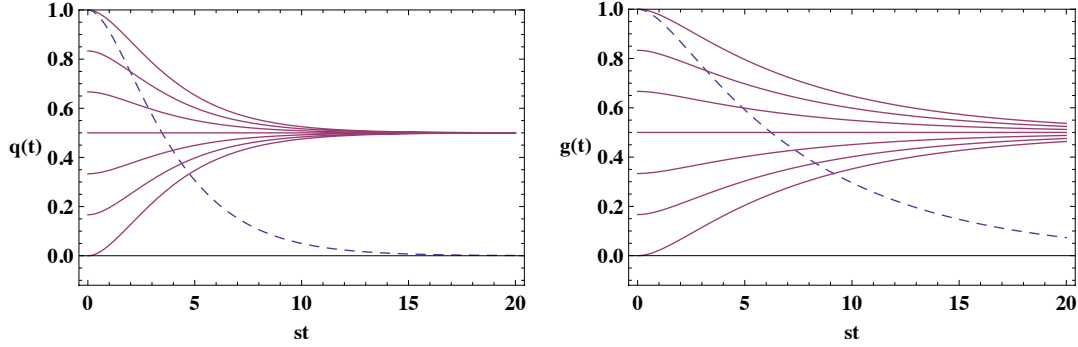

Figure 4.2: (left) Plot of the function $q(t)$ (dashed line) and of the trajectories (continuous lines) as in Fig. (4.1), but for the convolution of two different exponential waiting time distributions. We plot q as a function of st , taking $p/s^2 = 0.12$, with s and p sum and product of the two parameters characterizing the exponential waiting time distributions as in Eq. (4.44). For this case the quantity χ given by Eq. (4.46) is positive, ensuring monotonicity of $q(t)$. (right) Plot of $g(t)$ and the corresponding trajectories for the same waiting time distribution.

and

$$q(t) = e^{-\frac{1}{2}(\lambda_1 + \lambda_2 + \langle \lambda \rangle)t} \left[\text{Cosh} \left(\frac{\bar{\lambda}t}{2} \right) + \frac{(\lambda_1 + \lambda_2 - 3\langle \lambda \rangle)}{\bar{\lambda}} \text{Sinh} \left(\frac{\bar{\lambda}t}{2} \right) \right], \quad (4.49)$$

with

$$\langle \lambda \rangle = \mu\lambda_1 + (1 - \mu)\lambda_2 \quad (4.50)$$

the mean rate and

$$\bar{\lambda} = \sqrt{(\lambda_1 + \lambda_2 + \langle \lambda \rangle)^2 - 8\lambda_1\lambda_2}. \quad (4.51)$$

This case is considered in Fig. (4.3).

It should be noticed that in all these situations the process is non-Markovian, but P-divisibility of the time evolution in the sense of Eq. (4.8) still holds in some cases. For a semi-Markov process with semi-Markov matrix as in Eq. (4.25) and $\pi = 1/2$, P-divisibility always holds, in particular as shown in the examples the trajectories never cross and $|q(t)|$ never grows. For $\pi = 1$ on the contrary the behavior depends on the waiting time distribution, which determines whether or not the quantity $q(t)$ shows an oscillating behavior, implying that the trajectories start getting closer till they cross and then get apart once again.

4.1.4 Conditional probability of a semi-Markov process

In the previous paragraphs, we have seen how P-divisibility is a necessary but not sufficient condition for the conditional probability of a given process to satisfy the Chapman-Kolmogorov equation. This is due to the fact that the transition map $\Lambda(t, s)$, that connects vector states at different

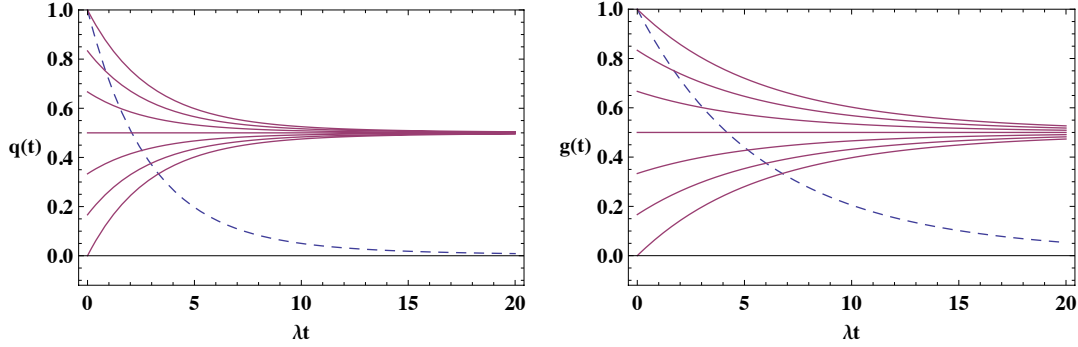

Figure 4.3: (left) Plot of $q(t)$ (dashed line) and the trajectories (continuous lines) as in Fig. (4.1), but for the convex mixture of two different exponential waiting time distributions. We plot q as a function of λt , taking $\lambda_1 = a_1\lambda$ and $\lambda_2 = a_2\lambda$, with $a_1 = 0.1$ and $a_2 = 0.2$, together with mixing parameter $\mu = 0.3$. (right) Plot of $g(t)$ and the corresponding trajectories for the same waiting time distribution.

times through Eq. (4.10), does not necessarily coincide with the actual conditional probability $p_{1|1}(t, s)$ of the process, so that, in general, Eq. (4.8) gives no information about the validity of Eq. (4.3). The crucial point is that the conditional probabilities of non-Markov processes generally depend on the initial distribution $\mathbf{p}(0)$ [108], contrary to the transition maps which are fixed by the equation of motion for the one-point probability distribution $\mathbf{p}(t)$ and the corresponding dynamical map, see Eq. (4.9). In this paragraph, we determine the conditional probability $p_{1|1}(t|s)$ for one of the semi-Markov processes introduced in the previous paragraph, thus explicitly showing its dependence on the initial distribution.

Consider a semi-Markov process defined by a semi-Markov matrix as in Eq. (4.25) and let a and b be the two states over which it takes values. In particular, if we set $\pi = 1$, so that the system changes its state with certainty at every jump, each realization of the process depends only on the initial state and on the waiting time distribution $f(t)$. For example, if the system is initially in a , the probability that it is in a also at a time t is simply given by the probability that there is an even number of jumps up to time t . On a similar footing, the conditional probabilities are determined by the initial distribution and the probabilities of even and odd number of jumps, as well. Let us introduce the matrices $R_{\mathbf{p}(0)}(t|s) \equiv p_{1|1}(t|s)$ with the varying of $\mathbf{p}(0)$, whose elements equal the conditional probabilities $p_{1|1}(j, t|k, s)$, $j, k = a, b$ and where the dependence on the initial distribution $\mathbf{p}(0)$ has been explicitly indicated. Consider for simplicity the two special cases of a deterministic initial condition, $p_j(0) = \delta_{jk}$ with $k = a$ or $k = b$, and the corresponding matrices $R_{\mathbf{p}(0)}(t|s)$, which will be indicated as, respectively, $R_a(t|s)$ and $R_b(t|s)$. Now, if we call $p_{eo}(t|s)$ the probability that there is even number of jumps up to time t under the condition that there is an odd number of jumps up to time s (and similarly for the other cases), we have (for $t \geq s > 0$)

$$R_a(t|s) = \begin{pmatrix} p_{ee}(t|s) & p_{eo}(t|s) \\ p_{oe}(t|s) & p_{oo}(t|s) \end{pmatrix} \quad R_b(t|s) = \begin{pmatrix} p_{oo}(t|s) & p_{oe}(t|s) \\ p_{eo}(t|s) & p_{ee}(t|s) \end{pmatrix}. \quad (4.52)$$

For the sake of completeness, the conditional probabilities for a generic initial distribution, with $p_a(0) = 1 - p_b(0) = w$, can be expressed as

$$R_{\mathbf{p}(0)}(t|s) = \begin{pmatrix} \frac{wp_e(s)p_{ee}(t|s)+(1-w)p_o(s)p_{oo}(t|s)}{wp_e(s)+p_o(s)} & \frac{wp_o(s)p_{eo}(t|s)+(1-w)p_e(s)p_{oe}(t|s)}{wp_o(s)+p_e(s)} \\ \frac{wp_e(s)p_{oe}(t|s)+(1-w)p_o(s)p_{eo}(t|s)}{wp_e(s)+p_o(s)} & \frac{wp_o(s)p_{oo}(t|s)+(1-w)p_e(s)p_{ee}(t|s)}{wp_o(s)+p_e(s)} \end{pmatrix}, \quad (4.53)$$

where $p_{e(o)}(t)$ is the probability that there is an even (odd) number of jumps up to time t .

The conditional probabilities in Eq. (4.52) can be obtained from the collection of joint probabilities of the renewal process which counts the number of jumps up to time t . Let $p(n, t; m, s)$ be the probability that there are m jumps up to time s and n jumps up to time t , then it holds

$$p_{ee}(t|s) = \frac{\sum_{m,n} p(2n, t; 2m, s)}{\sum_n p(2n, s)}, \quad (4.54)$$

and similarly for the other expressions. In order to calculate the joint probabilities of the renewal process, let us first express its one-point probability $p(n, t)$ as follows. Iterating Eq. (4.12), one gets

$$p(n, t) = \int_0^t dt_n \int_0^{t_n} dt_{n-1} \dots \int_0^{t_2} dt_1 f(t - t_n) f(t_n - t_{n-1}) \dots f(t_2 - t_1) g(t_1), \quad (4.55)$$

where $g(t) = p(0, t)$ is the survival probability up to time t . Introducing the time variables

$$\begin{aligned} t'_1 &= t - t_n \\ t'_2 - t'_1 &= t_n - t_{n-1} \\ &\vdots \\ t'_n - t'_{n-1} &= t_2 - t_1, \end{aligned} \quad (4.56)$$

Eq. (4.55) can be written as

$$p(n, t) = \int_0^t dt'_n \int_0^{t'_n} dt'_{n-1} \dots \int_0^{t'_2} dt'_1 f(t'_1) f(t'_2 - t'_1) \dots f(t'_n - t'_{n-1}) g(t - t'_n). \quad (4.57)$$

Starting from Eq. (4.57), we can read t'_j as the time of the j -th jump. Note in particular that the survival probability is evaluated on the interval between the time of the n -th jump and the time t , so that it gives the probability that the n -th jump is actually the last one up to time t . For a fixed sequence of time (t'_1, \dots, t'_n) the probability density that there are n jumps up to time t , with the j -th jump that occurs at time t'_j , is given by the product of the different waiting time distributions evaluated on the corresponding time intervals, as well as the probability that in the last time interval there are no more jumps. The overall probability is obtained by integrating over all the possible sequence of time $(t'_1, \leq t'_2 \leq \dots \leq t'_n)$. In the same manner, the joint probability can be written as (for $t \geq s$ and $n \geq m$)

$$\begin{aligned} p(n, t; m, s) &= \int_s^t dt'_{n-m} \int_s^{t'_{n-m}} dt'_{n-m-1} \dots \int_s^{t'_2} dt'_1 \int_0^s dt_m \int_0^{t_m} dt_{m-1} \dots \int_0^{t_2} dt_1 \\ &\times f(t_1) f(t_2 - t_1) \dots f(t_m - t_{m-1}) f(t'_1 - t_m) f(t'_2 - t'_1) \dots f(t'_{n-m} - t'_{n-m-1}) g(t - t'_{n-m}), \end{aligned} \quad (4.58)$$

since now the first m jumps are at times $(t_1 \leq t_2 \leq \dots \leq t_m)$ between 0 and s , while the successive $n - m$ jumps are at times $(t'_1 \leq t'_2 \leq \dots \leq t'_{n-m})$ between s and t . Note that the two sequences are connected by means of the waiting time distribution $f(t'_1 - t_m)$ associated with the time interval between the m -th and the $m + 1$ -th jump. By means of Eqs. (4.54) and (4.58), we can thus calculate the conditional probabilities in Eq. (4.52). In Table (4.1) we report these

Table 4.1: Conditional probabilities for a renewal process with $f(t)$ as in Eq. (4.36), with $\lambda = 1$.

$p_{ee}(2 1)$	0.601
$p_{eo}(2 1)$	0.322
$p_{oe}(2 1)$	0.399
$p_{oo}(2 1)$	0.678

quantities for a waiting time distribution $f(t)$ given by the convolution of two identical exponential distributions³ with $\lambda = 1$, see Eq. (4.36). One can conclude that $R_e(t|s) \neq R_g(t|s)$, so that the conditional probability of this semi-Markov process does depend on the initial conditions.

On the other hand, if an exponential waiting time distribution is employed in Eq. (4.58), one recovers the joint probabilities of a Poisson process, namely

$$p(n, t; m, s) = e^{-\lambda t} \lambda^n \frac{(t - s)^{n-m} s^m}{(n - m)! m!}. \quad (4.59)$$

Substituting this expression in Eq. (4.54), together with the one point probability distribution

$$p(m, s) = e^{-\lambda s} \frac{(\lambda s)^m}{m!}, \quad (4.60)$$

one finds that $p_{ee} = p_{oo}$ and $p_{eo} = p_{oe}$: in the Markovian case the conditional probability does not depend on the initial distribution, so that $R_a(t|s) = R_b(t|s) = R_{p(0)}(t|s)$, see Eq. (4.53). Furthermore, the matrix of conditional probabilities $R_{p(0)}(t|s)$ for this two-state Markovian process is equal to the corresponding transition map $\Lambda(t, s)$, that is defined in Eq. (4.33), and then it satisfies the Chapman-Kolmogorov equation that, in this case, is equivalent to P-divisibility. Recalling that $q(t)$ is the difference between the probabilities of an even and an odd number of events up to time t , see Eq. (4.35), and that the conditional probabilities are given by Eq. (4.52), we explicitly have

$$p_{ee}(t|s) = p_{oo}(t|s) = 1 - p_{eo}(t|s) = 1 - p_{oe}(t|s) = \frac{1}{2} \left(1 + \frac{q(t)}{q(s)} \right) = \frac{1}{2} \left(1 + e^{-2\lambda(t-s)} \right). \quad (4.61)$$

Thus, the difference between conditional probability and transition map relies on the fact that the former is *not* a linear map on the set of state vectors, because of its dependence on the initial

³The one-point probability for such a renewal process is given by

$$p(n, t) = e^{-\lambda t} \left(\frac{(\lambda t)^{2n}}{(2n)!} + \frac{(\lambda t)^{2n+1}}{(2n+1)!} \right)$$

distribution $\mathbf{p}(0)$. So that, for example, even if the two relations

$$\begin{aligned}\mathbf{p}(t) &= \Lambda(t, s)\mathbf{p}(s) \\ \mathbf{p}(t) &= R_{\mathbf{p}(0)}(t|s)\mathbf{p}(s)\end{aligned}\quad (4.62)$$

hold, one cannot conclude that the conditional probability and the transition map are equal: if $\mathbf{p}(0)$ is changed, thus providing different $\mathbf{p}(s)$ and $\mathbf{p}(t)$, also $R_{\mathbf{p}(0)}(t|s)$ has to be changed accordingly, while the linear map $\Lambda(t, s)$, which is fixed through Eq. (4.9), stays the same. Analogously, by the very definition of conditional probability, one can derive the relation

$$R_{\mathbf{p}(0)}(t|t_1)\mathbf{p}(t_1) = R_{\mathbf{p}(0)}(t|s)R_{\mathbf{p}(0)}(s|t_1)\mathbf{p}(t_1). \quad (4.63)$$

However, this does not imply an equality between the two matrices $R_{\mathbf{p}(0)}(t|s)R_{\mathbf{p}(0)}(s|t_1)$ and $R_{\mathbf{p}(0)}(t|t_1)$, because of their dependence on $\mathbf{p}(0)$. Only if the conditional probability does not depend on $\mathbf{p}(0)$, Eq. (4.63) reduces to the Chapman-Kolmogorov equation Eq. (4.3). In this case, the Chapman-Kolmogorov equation and the requirement of P-divisibility are thus actually equivalent. As a further remark, let us note that in the examples of the previous paragraph one can see that whenever the requirement of P-divisibility is satisfied, the one-point probability distribution obeys, apart from an integrodifferential equation of the form Eq. (4.20) with $W_{jk}(t)$ given by Eq. (4.27), a Pauli master equation as in Eq. (4.5) with positive coefficients W , which can be shown as follows. First, let us emphasize that the time evolution of one-point probability distributions in the classical setting can be analyzed by means of the same techniques we introduced in Sec. (3.1) for quantum dynamics. A family of classical dynamical maps $\{\Lambda(t, 0)\}_{t \geq 0}$, for example, can correspond at the same time to a local as well as to a non-local equation of motion⁴ [109, 110, 111]. In particular, the time-local equation is obtained through, compare with Eq. (3.19),

$$\frac{d}{dt}\mathbf{p}(t) = \frac{d\Lambda(t, 0)}{dt}\Lambda^{-1}(t, 0)\mathbf{p}(t). \quad (4.64)$$

For a dynamical map as in Eq. (4.32), one has

$$\begin{aligned}\dot{p}_1(t) &= -\frac{\dot{q}(t)}{2q(t)}(p_0(t) - p_1(t)), \\ \dot{p}_0(t) &= -\frac{\dot{q}(t)}{2q(t)}(p_1(t) - p_0(t)).\end{aligned}\quad (4.65)$$

This equation corresponds to Eq. (4.5) with, in matrix notation, $W_{11}(t) = W_{00}(t) = W_{10}(t) = W_{01}(t) = -\dot{q}(t)/2q(t)$, so that $W_{jk}(t) \geq 0 \forall t \geq 0$ if and only if $|q(t)|$ is monotonically decreasing, that is if and only if the family of dynamical maps $\{\Lambda(t, 0)\}_{t \geq 0}$ is P-divisible. Indeed, this is true irrespective of whether the underlying process fulfills the Chapman-Kolmogorov equation and then we clearly see that the differential Chapman-Kolmogorov equation in Eq. (4.4) and the Pauli master equation in Eq. (4.5) are not equivalent. Once again, the Markovianity of a given process cannot be assessed from the equation of motion of its one-point probability.

⁴The problem of detecting those equations of motion for $\mathbf{p}(t)$ which describe a well-defined time evolution is as difficult to solve as the corresponding problem for the statistical operator $\rho(t)$, see e.g. [120].

4.1.5 Kolmogorov distance

Let us now consider a second signature of non-Markovianity in the dynamics of the one-point probability distribution $\mathbf{p}(t)$. Namely, let us analyze the time dependence of the Kolmogorov distance among probability distributions arising from different initial states. The Kolmogorov distance is briefly introduced in Appendix C. Given two probability vectors $\mathbf{p}^1(t)$ and $\mathbf{p}^2(t)$, the Kolmogorov distance between them is, see Eq. (C.11),

$$D_K(\mathbf{p}^1(t), \mathbf{p}^2(t)) = \frac{1}{2} \sum_k |p_k^1(t) - p_k^2(t)|. \quad (4.66)$$

A basic property of the Kolmogorov distance, which makes it a useful quantity in this context, is the following. If the family of dynamical maps $\{\Lambda(t, 0)\}_{t \geq 0}$ is P-divisible in the sense of Eq. (4.8), then the Kolmogorov distance is a monotonic decreasing function of time for any pair of initial distributions $\mathbf{p}^1(0)$ and $\mathbf{p}^2(0)$. Indeed, by the two basic properties of a stochastic matrix, the positivity of its entries and the fact that each row sum up to one, one has for $t \geq s \geq 0$

$$\begin{aligned} D_K(\mathbf{p}^1(t), \mathbf{p}^2(t)) &= \frac{1}{2} \sum_j \left| \sum_k \Lambda(t, s)_{jk} (\mathbf{p}^1(s) - \mathbf{p}^2(s))_k \right| \\ &\leq \frac{1}{2} \sum_j \sum_k \Lambda(t, s)_{jk} |(\mathbf{p}^1(s) - \mathbf{p}^2(s))_k| \\ &= \frac{1}{2} \sum_k |(\mathbf{p}^1(s) - \mathbf{p}^2(s))_k| \\ &= D_K(\mathbf{p}^1(s), \mathbf{p}^2(s)). \end{aligned} \quad (4.67)$$

This holds true independently of the fact that the underlying classical process is Markovian or not, it only depends on the fact the one-point probabilities can be related at different times via stochastic matrices.

In a generic non-Markovian situation the Kolmogorov distance can both show a monotonic decreasing behavior as well as revivals. Indeed, focusing on the examples considered above, for a semi-Markov matrix as in Eq. (4.25) and $\pi = 1/2$ one has

$$D_K(\mathbf{p}^1(t), \mathbf{p}^2(t)) = g(t) D_K(\mathbf{p}^1(0), \mathbf{p}^2(0)), \quad (4.68)$$

while for $\pi = 1$ one has

$$D_K(\mathbf{p}^1(t), \mathbf{p}^2(t)) = |q(t)| D_K(\mathbf{p}^1(0), \mathbf{p}^2(0)). \quad (4.69)$$

Thus while for $\pi = 1/2$ the Kolmogorov distance is a monotonic contraction for any waiting time distribution, thanks to the fact that $g(t)$ is a survival probability, for $\pi = 1$ the distance among distributions can show revivals depending on the explicit expression of $q(t)$, as can be seen from Fig. (4.1) for the case of the convolution of two exponential waiting time distributions with the same parameter. Note that in the examples considered so far, decreasing monotonicity

of Kolmogorov distance and P-divisibility actually coincide, but this is not always the case, see Appendix E.

We have thus studied, by means of explicit examples, the behavior of the probability vector or one-point probability $\mathbf{p}(t)$ of a classical process. In particular, we have seen that while for a Markovian process P-divisibility is always granted and, as a consequence, the Kolmogorov distance is a monotone contraction, non-Markovianity can spoil these features, even though neither the lack of P-divisibility nor the growth of the Kolmogorov distance can be taken as necessary signatures of non-Markovianity. This substantiates the fact that the non-Markovianity of a classical process cannot be traced back to the behavior of the one-point probabilities only, since it involves all n -point probabilities.

4.2 Quantum non-Markovian dynamics

We now come back to the quantum realm, studying a class of quantum dynamics which have a clearcut physical meaning, allowing both for the evaluation and the comparison of two recently introduced measures of non-Markovianity for the quantum case, and for a direct connection with the classical situation analyzed in Sec. (4.1). Such approaches to non-Markovianity in quantum dynamics cope with the behavior of one-point probabilities only, which can be obtained from the statistical operator $\rho(t)$, since a definition involving the whole hierarchy of n -point probabilities cannot be introduced without explicit reference to a particular choice of measurement scheme. Note that one speaks about measures of non-Markovianity, since apart from clarifying what is the signature of non-Markovianity, so as to define it and therefore make it detectable, one would like to quantify the degree of non-Markovianity of a given dynamics. For example, given a certain model, it is of interest to determine how the memory effects in the open-system dynamics are influenced by the parameters of the system [121, 122, 123] as well as by correlation properties of the environment [124].

The two measures that we will consider here [19, 20] respectively rely on the violation of the quantum analog of the classical properties of P-divisibility and on monotonic decrease in time of the trace distance, which is the quantum counterpart of the Kolmogorov distance (see Appendix C), while also other approaches have been introduced [18]. Note that the violation of these properties in the classical case provide a sufficient but not necessary condition to detect a non-Markovian process, as clarified in the examples considered in Sec. (4.1.3). The measure of non-Markovianity relying on backflow of information is presented in Appendix E.

Before proceeding, let us introduce the notion of P-divisibility, in addition to CP-divisibility, also in the quantum setting. A one-parameter family of dynamical maps $\{\Lambda(t, 0)\}_{t \geq 0}$ is said to be P-divisible if $\Lambda(t, 0)$ can be decomposed as in Eq. (3.116) with $\Lambda(t, s)$ positive map, for any $t \geq s \geq 0$. Of course, CP-divisibility implies P-divisibility, but the opposite is not true, as will be shown in the following. In Appendix E the relation between P-divisibility and non-Markovianity of quantum dynamics is analyzed in more details. Finally, let us note that P-divisibility is enough to guarantee that the transition maps $\Lambda(t, s)$ send states into states and that the trace distance $D(\rho_S^1(t), \rho_S^2(t))$ evolves in a monotonically decreasing way, as a direct consequence of the theorem in Appendix C.

4.2.1 Quantum semi-Markovian dynamics

As in the classical case, in order to study the Markovian or non-Markovian features of a quantum dynamics we take into account a class of time evolutions that allow for an explicit treatment and the connection to a classical counterpart [92, 93], see also Sec. (3.3.4). Consider an integrodifferential master equation as in Eq. (3.46), with generic $\sigma_\alpha \in \mathcal{L}(\mathbb{C}^N)$ and real functions $r_\alpha(t)$, while $H^\dagger(t) = H(t)$. Whenever the populations $p_k \equiv \langle k | \rho(t) | k \rangle$, $k = 1, \dots, N$ obey a closed equation of motion, the latter takes the form as Eq. (4.20) for the one-point probability distribution of a classical semi-Markov process, with

$$W_{kj}(t) = \sum_{\alpha} r_{\alpha}(t) |\langle k | \sigma_{\alpha}(t) | j \rangle|^2. \quad (4.70)$$

Note that an analogous relation holds between the time-dependent Lindblad equation and the Pauli master equation. Consider at first the case in which $W_{kj}(t) \geq 0$ and Eq. (3.137) is satisfied, so that

$$\sum_j W_{jk}(t) = b_k(t) \quad (4.71)$$

and the complete positivity of the evolution is guaranteed by the condition in Eq. (3.140). From Eq. (3.139) one can see that $g_k(t) \equiv g_{kk}(t)$ and $b_k(t)$ satisfy Eq. (4.23), while the condition for complete positivity implies that $g_k(t) \geq 0$, which, together with $b_k(t) \geq 0$, allows to read $g_k(t)$ as the survival probability associated with a well-defined waiting time distribution $f_k(t)$ through Eq. (4.22). The constitutive elements of a classical semi-Markov process are in this way introduced. It is worth emphasizing that, as for the classical counterpart, the positivity of $W_{kj}(t)$ in Eq. (4.70) is not a priori requested. Thus, more generally, we will use the term *quantum semi-Markov dynamics* every time the coefficients $W_{kj}(t)$ in Eq. (4.70) allow to define a classical semi-Markov process, i.e., to introduce proper waiting time distributions and survival probabilities through Eqs. (4.71), (4.22) and (4.23).

In the following, we will focus on the special case represented by Eq. (3.141), such that the integrodifferential equation reads

$$\frac{d}{dt} \rho(t) = \int_0^t d\tau b(t-\tau) [\mathcal{E} - \mathbb{1}] \rho(\tau), \quad (4.72)$$

with \mathcal{E} completely positive trace preserving map. For a suitable memory function $b(t)$, one can proceed as before and introduce a classical semi-Markov which, in this case, is characterized by a state-independent waiting time distribution $f(t)$. The latter can be directly obtained through the relation in Laplace transform, see Eq. (4.24),

$$\hat{f}(u) = \frac{\hat{b}(u)}{u + \hat{b}(u)}. \quad (4.73)$$

Moreover, applying the expansion in Eq. (3.136), one gets

$$\rho(t) = \rho(0) + \sum_n \int_0^t dt_n \dots \int_0^{t_2} dt_1 f(t-t_n) \mathcal{E} f(t_n - t_{n-1}) \dots \mathcal{E} f(t_2 - t_1) g(t_1) \mathcal{E} \rho(0), \quad (4.74)$$

where we used $R(t) = b(t)\mathbb{1}$ and $f(t) = (b \star g)(t)$, see Eq. (4.22). This formula has a clear statistical interpretation [94] recalling that the probability $p(n, t)$ of n events up to time t in a renewal process characterized by a waiting time distribution $f(t)$ is given by Eq. (4.55), so that one has

$$\rho(t) = \sum_{n=0}^{\infty} p(n, t) \mathcal{E}^n \rho(0), \quad (4.75)$$

where \mathcal{E}^n denotes the n -fold composition of the map \mathcal{E} . The CPT map \mathcal{E} can then be interpreted as an instantaneous intervention of the environment over the reduced system: the overall quantum dynamics is due to a sequence of such interventions, randomly distributed in time according to a renewal process with waiting time distribution $f(t)$. Note that Eq. (4.75) guarantees the complete positivity of the dynamics as long as $f(t)$ can be read as a waiting time distribution, so that the underlying statistical interpretation is well-defined.

4.2.2 Example: dephasing dynamics

In Sec. (4.1) we considered semi-Markov processes with a semi-Markov matrix of the form Eq. (4.25), with arbitrary $f(t)$ and Π a bistochastic matrix. Markovianity or non-Markovianity of the process only depended on the choice of $f(t)$, while P-divisibility and behavior of the Kolmogorov distance did depend on both $f(t)$ and Π . In the quantum setting we also leave $f(t)$ arbitrary and consider bistochastic CPT maps, in the sense that $\mathcal{E}[\mathbb{1}] = \mathbb{1}$, so that also $\Lambda(t, 0)$ is bistochastic, preserving both the trace and the identity.

A purely quantum dynamics, only affecting coherences, is obtained by considering the CPT map

$$\mathcal{E}_z \rho = \sigma_z \rho \sigma_z, \quad (4.76)$$

which describes dephasing. It is to be stressed that while a dephasing dynamics can be formally represented in terms of the action of local random unitary operators, e.g. due to random fluctuating fields [125], it arises in many physically interesting situations and the relevance of non-Markovian effects in this setting has recently been the object of both theoretical as well as experimental efforts (see e.g. [126] and [127]). The map \mathcal{E}_z satisfies $\mathcal{E}_z^{2n} = \mathbb{1}$ and $\mathcal{E}_z^{2n+1} = \mathcal{E}_z$, so that one has

$$\rho(t) = p(\text{even}, t) \rho(0) + p(\text{odd}, t) \sigma_z \rho(0) \sigma_z = \begin{pmatrix} \rho_{11}(0) & q(t) \rho_{10}(0) \\ q(t) \rho_{01}(0) & \rho_{00}(0) \end{pmatrix}, \quad (4.77)$$

recalling the definition Eq. (4.35) of $q(t)$ and considering matrix elements in the basis of eigenvectors of σ_z . Before addressing the issue of the characterization of these dynamics, it is of interest to recast the integrodifferential master equation Eq. (4.72) in a time-convolutionless form. Indeed, while Markovianity or non-Markovianity is a property of the solution $\rho(t)$, rather than of the equation, it is quite important to read signatures of a non-Markovian behavior from the equations themselves, and this task turns out to be much easier when the equations are written in time-local form. To rewrite the master equation Eq. (4.72) in time-local form we follow the approach introduced in Sec. (3.1). The matrix $\Lambda(t, 0)$ associated with the dynamical map $\Lambda(t, 0)$ through the

representation given by Eqs. (2.41) and (2.42) with respect to the usual basis $\left\{ \frac{1}{\sqrt{2}} \mathbb{1}, \frac{1}{\sqrt{2}} \sigma_k \right\}_{k=1,2,3}$ is given by

$$\Lambda(t, 0) = \text{diag}(1, q(t), q(t), 1). \quad (4.78)$$

Accordingly, the time-convolutionless master equation obtained through Eq. (3.24) simply reads

$$\frac{d}{dt} \rho(t) = \gamma(t) \mathcal{L}_z[\rho(t)], \quad (4.79)$$

where we have a single quantum channel given by

$$\mathcal{L}_z[\rho] = \sigma_z \rho \sigma_z - \rho \quad (4.80)$$

and the time dependent coefficient $\gamma(t)$ is

$$\gamma(t) = -\frac{1}{2} \frac{\dot{q}(t)}{q(t)} = -\frac{1}{2} \frac{d}{dt} \log |q(t)|. \quad (4.81)$$

Divisibility

Relying on the matrix representation of the map $\Lambda(t, 0)$ given by Eq. (4.78) we are now in the position to study its divisibility. In particular the one-parameter family of dynamical maps $\{\Lambda(t, 0)\}_{t \geq 0}$ turns out to be P-divisible if the matrices

$$\Lambda(t, s) = \text{diag}\left(1, \frac{q(t)}{q(s)}, \frac{q(t)}{q(s)}, 1\right) \quad (4.82)$$

obtained as in Eq. (3.118) represent positive maps $\Lambda(t, s)$ for any $t \geq s \geq 0$, which is the case provided

$$\left| \frac{q(t)}{q(s)} \right| \leq 1. \quad (4.83)$$

This condition is satisfied if $|q(t)|$ is a monotonic decreasing function, and therefore the time dependent coefficient $\gamma(t)$ is always positive. In order to assess when CP-divisibility holds, one can consider positivity of the associated Choi matrix, see Sec. (2.2.4), which still leads to the constraint in Eq. (4.83). It follows that for this model CP-divisibility and P-divisibility are violated at the same time, whenever $|q(t)|$ increases, so that $\gamma(t)$ becomes negative. Thus, as discussed in [21], for the case of a single quantum channel positivity of the time dependent coefficient ensures CP-divisibility of the time evolution, which is violated if $\gamma(t)$ becomes negative at some point.

Measures of non-Markovianity

We can now evaluate the measures of non-Markovianity for this model according to both approaches devised in [19] and in [20]. The first approach by Breuer, Laine and Piilo relies on the

study of the behavior in time of the trace distance $D(\rho^1(t), \rho^2(t))$ between a pair of reduced states evolved from different initial states $\rho^1(0)$ and $\rho^2(0)$. The trace distance among two quantum states ρ^1 and ρ^2 quantifies their distinguishability and it provides the natural quantum analog of the Kolmogorov distance, see Appendix C. These authors identify the Markovianity of a quantum dynamics with the property of the corresponding family of dynamical maps to yield a monotonic decrease in time of the trace distance $D(\rho^1(t), \rho^2(t))$, for any pair of reduced initial states $\rho^1(0)$ and $\rho^2(0)$. The physical meaning of this definition relies on the idea that non-Markovian dynamics are characterized by a backflow of information from the environment to the open system, as discussed in Appendix E. Here, we want to emphasize that this provides a generalization to the quantum case of the criterion introduced in Sec. (4.1.5) for classical dynamics. The measure of non-Markovianity $\mathcal{N}(\Lambda)$, for a time evolution described by $\{\Lambda(t, 0)\}_{t \geq 0}$, is given by Eq. (E.3), where we recall that Ω_+ is the region where the rate $\sigma(t, \rho^{1,2}(0))$ defined in Eq. (E.2) is positive. For our case, the trace distance is given by

$$D(\rho^1(t), \rho^2(t)) = \sqrt{\Delta_p(0)^2 + |\Delta_c(0)|^2} q^2(t), \quad (4.84)$$

where we have set

$$\Delta_p(0) = \rho_{11}^1(0) - \rho_{00}^2(0) \quad (4.85)$$

$$\Delta_c(0) = \rho_{10}^1(0) - \rho_{10}^2(0) \quad (4.86)$$

for the differences of the populations and the coherences between $\rho^1(0)$ and $\rho^2(0)$, respectively. Its time derivative is

$$\sigma(t, \rho^{1,2}(0)) = \frac{|\Delta_c(0)|^2}{\sqrt{\Delta_p(0)^2 + |\Delta_c(0)|^2}} q(t) \dot{q}(t), \quad (4.87)$$

so that the trace distance among states can indeed grow provided $q(t)$ and $\dot{q}(t)$ have the same sign, so that $|q(t)|$ does increase. Thus the map has a positive measure of non-Markovianity whenever P-divisibility or equivalently CP-divisibility is broken. The region Ω_+ now corresponds to the time intervals where $|q(t)|$ increases, and the maximum is obtained for initial states such that $\Delta_p(0) = 0$ and $\Delta_c(0) = 1$, so that we have the following explicit expression for the measure of non-Markovianity

$$\mathcal{N}(\Lambda) = \max_{\rho^{1,2}(0)} \int_{\Omega_+} dt \sigma(t, \rho^{1,2}(0)) = \int_{\Omega_+} dt \frac{d}{dt} |q(t)| = \sum_i (|q(b_i)| - |q(a_i)|), \quad (4.88)$$

where we have set $\Omega_+ = \bigcup_i (a_i, b_i)$. The couple of states which maximize the growth of the trace distance is given in this case by the pure states $\rho^{1,2}(0) = |\psi_{\pm}\rangle\langle\psi_{\pm}|$, with

$$|\psi_{\pm}\rangle = \frac{1}{\sqrt{2}} (|0\rangle \pm |1\rangle). \quad (4.89)$$

The approach by Rivas, Huelga and Plenio, instead, identifies the Markovianity of a quantum dynamics with the CP-divisibility of the corresponding family of dynamical maps. While for this

model this requirement for non-Markovianity is satisfied at the same time as the growth of the trace distance, the effect is quantified in a different way. These authors quantify non-Markovianity as the integral

$$\mathcal{I}(\Lambda) = \int_{\mathbb{R}_+} dt \mathfrak{g}(t) \quad (4.90)$$

where the quantity $\mathfrak{g}(t)$ is given by

$$\mathfrak{g}(t) = \lim_{\epsilon \rightarrow 0} \frac{\frac{1}{2} \|\Lambda_{\text{Choi}}(t, t + \epsilon)\|_1 - 1}{\epsilon}, \quad (4.91)$$

with Λ_{Choi} the Choi matrix associated through Eq. (2.66) with the map Λ , and it is different from zero only when CP-divisibility is broken. For the case at hand one has

$$\mathcal{I}(\Lambda) = \int_{\Omega_+} dt \frac{d}{dt} \log |q(t)| = \sum_i (\log |q(b_i)| - \log |q(a_i)|) = -2 \int_{\Omega_+} dt \gamma(t). \quad (4.92)$$

For this model the growth of $|q(t)|$ determines both the breaking of CP-divisibility as well as the growth of the trace distance, so that both approaches detect non-Markovianity at the same time, even if they quantify it in different ways. This is however not generally true⁵, as observed already in [21] and considered in [129, 100]. We will point to examples for the different performance of the two measures later on. Exploiting the results of Sec. (4.1.3) it is now interesting to consider explicit choices of waiting time distributions, so as to clarify the different possible behaviors.

Explicit examples

For the case of a memoryless waiting time distribution of the form Eq. (4.31), so that $b(t)$ is actually a delta function and $q(t) = \exp(-2\lambda t)$, according to Eq. (4.81) the function $\gamma(t)$ is simply given by the positive constant λ . Each non-Markovianity measure is easily assessed to be zero. To consider non trivial situations, non-Markovian in the classical case, let us first assume a waiting time distribution of the form Eq. (4.36), arising by convolving two exponential memoryless distributions with the same parameter. The function $q(t)$ is then given by Eq. (4.38), so that $\gamma(t)$ reads

$$\gamma(t) = \lambda \frac{1}{1 + \cotg(\lambda t)}, \quad (4.93)$$

which indeed takes on both positive and negative values, diverging for $\lambda t = (3/4)\pi \bmod \pi$. Both functions are plotted in Fig. (4.4). In this case the region Ω_+ can be exactly determined and is given by

$$\Omega_+ = \bigcup_{n \in \mathbb{N}} \left(\frac{1}{\lambda} (\pi + n\pi), \frac{1}{\lambda} \left(\frac{3}{4}\pi + n\pi \right) \right).$$

⁵Moreover, note that the two measures can order in different ways a class of quantum dynamics on the basis of the degree of non-Markovianity [128].

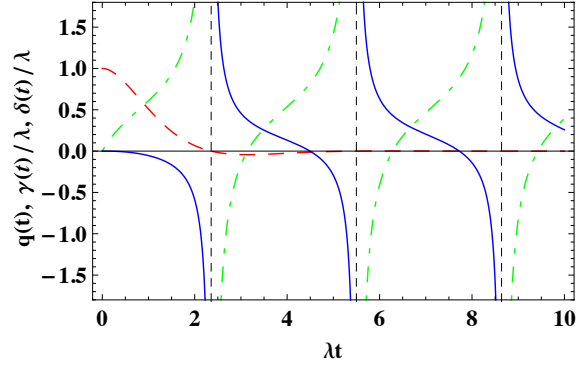

Figure 4.4: Plot of q (dashed line), γ (dot-dashed line) and δ (continuous line) defined in Eq. (4.35), Eq. (4.81) and Eq. (4.108) respectively, as functions of λt for the convolution of two equal exponential waiting time distributions. The vertical asymptotes denote the points where $q(t)$ goes through zero, so that $\gamma(t)$ diverges. The functions $\gamma(t)$ and $\delta(t)$ appear as time dependent coefficients in front of the various quantum channels in the time local quantum master equations given by Eq. (4.79) and Eq. (4.105), so that their sign determines the divisibility properties of the corresponding quantum dynamics, as discussed in the text.

As already observed both measure become nonzero when $|q(t)|$ grows. The measure proposed by Breuer, Laine and Piilo according to Eq. (4.88) can now be exactly calculated and it is given by

$$\mathcal{N}(\Lambda) = \sum_{n=0}^{\infty} (-1)^{n+1} \left[q\left(\frac{\pi + n\pi}{\lambda}\right) - q\left(\frac{3\pi/4 + n\pi}{\lambda}\right) \right] = \frac{1}{e^{\pi} - 1}, \quad (4.94)$$

which is finite and independent on λ . It is to be stressed that considering the convolution of a higher number of exponential waiting time distributions one obtains a higher value for this measure, according to the fact that the overall waiting time distribution departs more and more from the memoryless exponential case [118]. The measure proposed by Rivas, Huelga and Plenio instead is equal to infinity $\mathcal{I}(\Lambda) = \infty$, due to the fact that $q(t)$ goes through zero and therefore $\gamma(t)$ diverges. Actually, $\mathcal{I}(\Lambda)$ is equal to infinity whenever the inverse of time evolution map fails to exist. It therefore quantifies in the same way non-Markovianity for quite different situations, e.g. in this case waiting time distributions given by the convolution of a different number of exponentials.

As a further example, we consider a convolution of two different exponential distributions, corresponding to Eqs. (4.42) and (4.45), so that now one has

$$\gamma(t) = 2 \frac{p}{s} \frac{1}{1 + \chi \operatorname{Coth}\left(\frac{st}{2}\chi\right)}. \quad (4.95)$$

Recalling Eqs. (4.44) and (4.46), the argument of the hyperbolic cotangent is real, so that $\gamma(t)$ always stays positive, if $p \leq s^2/8$. In this case, despite the underlying non-Markovian classical process, both measures of non-Markovianity are equal to zero. The behavior of $q(t)$ and $\gamma(t)$ for

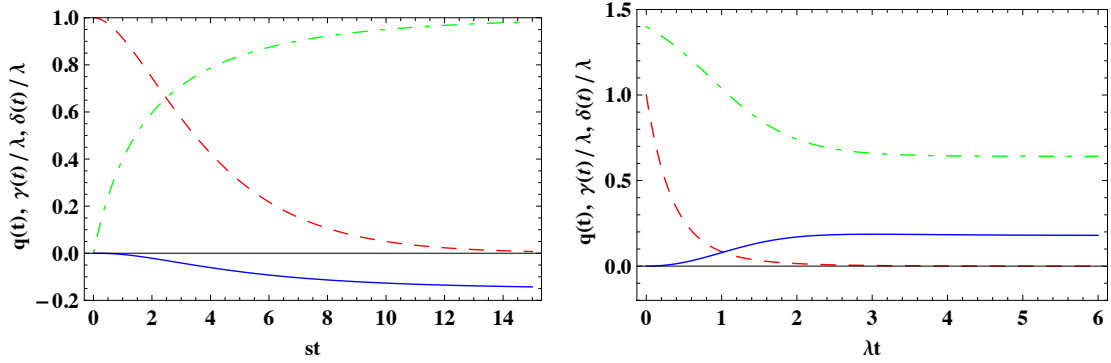

Figure 4.5: (left) The same as Fig. (4.4), but for the convolution of two different exponential waiting time distributions. We plot the quantities as a function of st , taking $p/s^2 = 0.12$. Note that in this case $\gamma(t)$ (dot-dashed line) is always positive, while $\delta(t)$ (continuous line) is always negative. The function $q(t)$ (dashed line) monotonically decreases reaching the value zero only at infinity. (right) The same as Fig. (4.4), but for a convex mixture of two different exponential waiting time distributions. We plot q (dashed line), γ (dot-dashed line) and δ (continuous line) as a function of λt , taking $\lambda_1 = a_1\lambda$ and $\lambda_2 = a_2\lambda$, with $a_1 = 1$ and $a_2 = 6$, together with mixing parameter $\mu = 0.6$. For this kind of waiting time distribution all functions always stay positive, quickly reaching an asymptotic constant value.

this case is depicted in Fig. (4.5) (left). When $p > s^2/8$, which includes the case $\lambda_1 = \lambda_2$, $q(t)$ again oscillates between positive and negative values, so that one has a similar behavior as before, with $\mathcal{N}(\Lambda)$ assuming a finite value and $\mathcal{I}(\Lambda) = \infty$.

Finally let us consider a convex mixture of two memoryless distributions as given by Eq. (4.47), so that $q(t)$ is now given by Eq. (4.49) and one has

$$\gamma(t) = \langle \lambda \rangle \frac{1 + \frac{1}{4} \frac{(\lambda_1 + \lambda_2 - 3\langle \lambda \rangle)(\lambda_1 + \lambda_2 + \langle \lambda \rangle) - \bar{\lambda}^2}{\bar{\lambda} \langle \lambda \rangle} \text{Coth}\left(\frac{\bar{\lambda} t}{2}\right)}{1 + \frac{(\lambda_1 + \lambda_2 - 3\langle \lambda \rangle)}{\bar{\lambda}} \text{Coth}\left(\frac{\bar{\lambda} t}{2}\right)}, \quad (4.96)$$

which according to the definitions of $\langle \lambda \rangle$ and $\bar{\lambda}$ given in Eq. (4.50) and Eq. (4.51) can be checked to always take on positive values. Its behavior is given in Fig. (4.5) (right). In this situation both measures are equal to zero.

Dephasing dynamics via projection

A quantum dynamics corresponding to pure dephasing is also obtained considering a CPT map \mathcal{E} which is a projection, that is

$$\mathcal{E}_P \rho = \sigma_+ \sigma_- \rho \sigma_+ \sigma_- + \sigma_- \sigma_+ \rho \sigma_- \sigma_+ \quad (4.97)$$

so that one has idempotency $\mathcal{E}_P^2 = \mathcal{E}_P$. For this case the analysis closely follows the one performed for \mathcal{E}_z , but the survival probability $g(t)$ is the crucial quantity instead of $q(t)$, similarly to the

classical case with $\pi = 1/2$ dealt with in Sec. (4.1.3). The matrix Λ is given by

$$\Lambda(t, 0) = \text{diag}(1, g(t), g(t), 1) \quad (4.98)$$

and the time-local master equation reads

$$\frac{d}{dt}\rho(t) = h(t)(\mathcal{L}_{+-}[\rho(t)] + \mathcal{L}_{-+}[\rho(t)]), \quad (4.99)$$

with Lindblad operators

$$\mathcal{L}_{+-}[\rho] = \sigma_+\sigma_-\rho\sigma_+\sigma_- - \frac{1}{2}\{\sigma_+\sigma_-, \rho\} \quad (4.100)$$

and similarly for \mathcal{L}_{-+} . The quantity $h(t)$ is given by

$$h(t) = \frac{f(t)}{g(t)} = -\frac{d}{dt}\log g(t), \quad (4.101)$$

which provides the so-called hazard rate function associated with the waiting time distribution $f(t)$, given by the ratio of waiting time distribution and survival probability. It gives information on the probability for the first jump to occur right after time t [114]. Note that the survival probability is a positive monotonously decreasing function, and the hazard rate function is always positive. As a result CP-divisibility always holds, so that both non-Markovianity measures are equal to zero, whatever the waiting time distribution is.

4.2.3 Example: dissipative dynamics

The choice of CPT map considered above, corresponding to pure dephasing, shows how different probability densities for the waiting time, corresponding to different distributions of the action of the quantum operation in time, can lead to dynamics whose measures of non-Markovianity can be both positive or zero, irrespective of the fact that the only memoryless waiting time distribution is the exponential one. In this case, however, there is no direct connection to a classical dynamics, since only the coherences evolve in time. Another natural choice of CPT map which leads to a non trivial dynamics for the populations is given by

$$\mathcal{E}_{\pm}\rho = \sigma_-\rho\sigma_+ + \sigma_+\rho\sigma_-. \quad (4.102)$$

As we now show this expression for the CPT map leads to a time-local master equation given by Eq. (4.105), where channels related to the operators σ_+ , σ_- and σ_z appear with, in particular, equal rates in front of the two dissipative channels. This example already serves the purpose to highlight the different behavior of the two distinct measures of non-Markovianity as discussed later, and it is amenable to a full analytical treatment. This makes the comparison with the classical case and the discussion of the various features more transparent. The map \mathcal{E}_{\pm} satisfies $\mathcal{E}_{\pm}^{2n} = \mathcal{E}_{\pm}^2$ and $\mathcal{E}_{\pm}^{2n+1} = \mathcal{E}_{\pm}$, so that one can obtain the explicit representation

$$\rho(t) = \begin{pmatrix} p(\text{even}, t)\rho_{11}(0) + p(\text{odd}, t)\rho_{00}(0) & g(t)\rho_{10}(0) \\ g(t)\rho_{01}(0) & p(\text{odd}, t)\rho_{11}(0) + p(\text{even}, t)\rho_{00}(0) \end{pmatrix}, \quad (4.103)$$

where $g(t)$ denotes as usual the survival probability. As in the previous case we can obtain the matrix $\Lambda(t, 0)$ representing the action of the map with respect to the chosen basis of operators in \mathbb{C}^2 , now given by

$$\Lambda(t, 0) = \text{diag}(1, g(t), g(t), q(t)). \quad (4.104)$$

Accordingly the time-convolutionless master equation reads

$$\frac{d}{dt}\rho(t) = \gamma(t) (\mathcal{L}_+[\rho(t)] + \mathcal{L}_-[\rho(t)]) + \delta(t) \mathcal{L}_z[\rho(t)], \quad (4.105)$$

where, apart from \mathcal{L}_z as given by Eq. (4.80), the quantum channels

$$\mathcal{L}_+[\rho] = \sigma_+\rho\sigma_- - \frac{1}{2}\{\sigma_-\sigma_+, \rho\} \quad (4.106)$$

and

$$\mathcal{L}_-[\rho] = \sigma_-\rho\sigma_+ - \frac{1}{2}\{\sigma_+\sigma_-, \rho\} \quad (4.107)$$

appear. The time dependent coefficient $\gamma(t)$ is still given by Eq. (4.81), while the function $\delta(t)$ is given by the difference

$$\delta(t) = \frac{1}{2}(h(t) - \gamma(t)), \quad (4.108)$$

where $h(t)$ is the hazard rate function introduced in Eq. (4.101), which is always positive.

Divisibility

Also in this case we can consider the divisibility properties of the time evolution. According to the matrix representation of the map, we now have

$$\Lambda(t, s) = \text{diag}\left(1, \frac{g(t)}{g(s)}, \frac{g(t)}{g(s)}, \frac{q(t)}{q(s)}\right), \quad (4.109)$$

so that thanks to the property of the survival probability the only condition for P-divisibility is still given by Eq. (4.83). Therefore the family of dynamical maps is P-divisible whenever $|q(t)|$ is a monotonic decreasing function. Note that this condition is equivalent to the positivity of $\gamma(t)$, and therefore of the time dependent coefficient in front of the \mathcal{L}_+ and \mathcal{L}_- channels, which affect the dynamics of the populations. In order to study CP-divisibility one has to consider the associated Choi matrix, whose positivity is granted upon the further condition, see Sec. (2.2.4) and in particular Eq. (2.86),

$$\frac{g(t)}{g(s)} \leq \frac{1}{2}\left(1 + \frac{q(t)}{q(s)}\right), \quad (4.110)$$

which sets a non trivial requirement, implying positivity of the function $\delta(t)$ which provides the coefficient of the purely quantum channel \mathcal{L}_z . Thus CP-divisibility is violated if and only if at

least one of the prefactors in the time-local form Eq. (4.105) becomes negative. Note however that in this case, due to the presence of different quantum channels, P-divisibility and CP-divisibility are not necessarily violated together, since it can well happen that $\gamma(t)$ stays positive, but $\delta(t)$ takes on negative values. As discussed in the examples below and shown in Fig. (4.5), for a suitable choice of waiting time distribution one can have a dynamics which is P-divisible, but not CP-divisible.

Measures of non-Markovianity

Also for this model we can obtain the explicit expression for the measures of non-Markovianity according to [19] and [20]. The trace distance now reads

$$D(\rho^1(t), \rho^2(t)) = \sqrt{q^2(t) \Delta_p(0)^2 + |\Delta_c(0)|^2 g^2(t)}, \quad (4.111)$$

where we have used the same notation as in Eqs. (4.85) and (4.86), so that the derivative is

$$\sigma(t, \rho^{1,2}(0)) = \frac{\Delta_p(0)^2 q(t) \dot{q}(t) - |\Delta_c(0)|^2 g(t) f(t)}{\sqrt{q^2(t) \Delta_p(0)^2 + |\Delta_c(0)|^2 g^2(t)}} \quad (4.112)$$

and can grow in the region Ω_+ where $q(t)$ and $\dot{q}(t)$ have the same sign. In this region $|q(t)|$ does increase and P-divisibility, but in general as we have seen not CP-divisibility, is granted. The growth is maximal for $\Delta_c(0) = 0$ and $\Delta_p(0) = 1$, so that the couple of states which maximize it is given by the projectors on ground and excited state. As a result, similarly as before we have for the measure of non-Markovianity introduced by Breuer, Laine and Piilo

$$\mathcal{N}(\Lambda) = \int_{\Omega_+} dt \frac{d}{dt} |q(t)| = \sum_i (|q(b_i)| - |q(a_i)|). \quad (4.113)$$

This result for the choice of CPT map \mathcal{E}_\pm is right the same as for the CPT map \mathcal{E}_z . This measure becomes nonzero if and only if P-divisibility is broken. It can be shown that this is always the case for a family of bistochastic dynamical maps on \mathbb{C}^2 , but not for more general situations, see Appendix E.

The criterion by Rivas, Huelga and Plenio instead assigns to the map a nonzero measure whenever one of the coefficients $\gamma(t)$ or $\delta(t)$ takes on negative values, so that CP-divisibility is broken. Since $h(t)$ is always positive, these two functions can take on negative values only on separate time intervals, as can also be seen from Fig. (4.4). The measure is then given by Eq. (4.90), where according to Eq. (4.91) we have $\mathfrak{g}(t) = 0$ whenever both $\gamma(t)$ and $\delta(t)$ are positive, while $\mathfrak{g}(t) = -2\gamma(t)$ whenever $\gamma(t)$ is negative, and $\mathfrak{g}(t) = -2\delta(t)$ in the complementary time intervals in which $\delta(t)$ takes on negative values. Note that $\mathcal{I}(\Lambda)$ can become positive even if the measure $\mathcal{N}(\Lambda)$ is zero. Indeed the latter measure for this dynamics is related to P-divisibility rather than CP-divisibility.

Population dynamics

For the dynamics described by Eq. (4.72), with the CPT map given by \mathcal{E}_\pm as in Eq. (4.102), coherences and populations decouple, and the populations obey the same equation as the one-point probability distribution of the classical semi-Markov processes considered in Sect. 4.1 for $\pi = 1$ and arbitrary waiting time distribution. This is immediately seen identifying the two components of the probability vector with the populations in excited and ground state. Setting $P_+(t) = \langle +|\rho(t)|+\rangle$ and $P_-(t) = \langle -|\rho(t)|-\rangle$ one has in fact from Eq. (4.72) with \mathcal{E}_\pm the integrodifferential equations

$$\frac{d}{dt}P_\pm(t) = \int_0^t d\tau b(t-\tau)[P_\mp(\tau) - P_\pm(\tau)] \quad (4.114)$$

corresponding to Eq. (4.26) for

$$W(\tau) = \begin{pmatrix} -1 & 1 \\ 1 & -1 \end{pmatrix} b(\tau). \quad (4.115)$$

As shown in Sec. (4.2.1) one can then construct a classical semi-Markov process with a state-independent waiting time distribution determined through Eq. (4.73), and whose one-point probability distribution satisfies Eq. (4.114).

The Kolmogorov distance as in Eq. (4.69) is given by

$$D_K(\{P_+^1(t), P_-^1(t)\}, \{P_+^2(t), P_-^2(t)\}) = |\Delta_p(0)| |q(t)|, \quad (4.116)$$

so that $\mathcal{N}(\Lambda)$, being obtained by considering as initial states the projections onto ground and excited state, is also given by taking the maximum over the possible initial classical states of the integral of the Kolmogorov-distance derivative σ_K in the time intervals in which it is positive. Growth of the Kolmogorov distance again depends on the behavior of $|q(t)|$ only, which determines whether the evolution is P-divisible or not. In view of these connection it appears that one can have non-Markovianity measure $\mathcal{N}(\Lambda)$ equal to zero even if the dynamics for the populations can be related to a non-Markovian classical process. Note that this is true also for the non-Markovianity measure $\mathcal{I}(\Lambda)$: CP-divisibility of the quantum evolution does not fix in any way the waiting time distribution of the associated classical semi-Markov process, see the last example in the next paragraph. Again this is not too surprising, since the one-point probabilities cannot really keep track of Markovianity or non-Markovianity in the classical sense, even though in the non-Markovian case they can show up different behaviors than those typical of the Markovian one.

Explicit examples

At variance with the case of pure dephasing, the two measures of non-Markovianity do not agree for this model. The measure $\mathcal{N}(\Lambda)$ becomes positive as soon as P-divisibility is broken, which depends on the sign of $\gamma(t)$ only, while $\mathcal{I}(\Lambda)$ becomes positive even when only CP-divisibility does not hold, which also depends on the sign of the function $\delta(t)$ appearing in front of the purely quantum channel \mathcal{L}_z , which determines the dynamics of the coherences. To consider the behavior

of the measures for this model we thus have to consider also the quantity $\delta(t)$, which is simply equal to zero for an exponential waiting time distribution, so that in the proper Markovian case this pure quantum channel is not available.

For the case of the convolution of two equal exponential distributions exploiting Eqs. (4.36) and (4.37) together with Eq. (4.93) we have

$$\delta(t) = \frac{\lambda}{2} \left(\frac{\lambda t}{1 + \lambda t} - \frac{1}{1 + \cot g(\lambda t)} \right), \quad (4.117)$$

so that both $\gamma(t)$ and $\delta(t)$ oscillate in sign and diverge when $\cot g(\lambda t)$ takes on the value minus one, as shown in Fig. (4.4). In this case both measures are positive, while considering the convolution of two different exponential distributions one has thanks to Eqs. (4.42), (4.43) and (4.95).

$$\delta(t) = \frac{p}{s} \left(\frac{1}{1 + \xi \operatorname{Coth}\left(\frac{st}{2}\xi\right)} - \frac{1}{1 + \chi \operatorname{Coth}\left(\frac{st}{2}\chi\right)} \right). \quad (4.118)$$

If the ratio λ_1/λ_2 is far enough from one, $\gamma(t)$ given by Eq. (4.95) as discussed above stays always positive, so that one has P-divisibility and the measure $\mathcal{N}(\Lambda)$ is equal to zero. On the contrary the function $\delta(t)$ is negative, so that the coefficient in front of the quantum channel is always negative and CP-divisibility is violated, thus determining a positive measure $\mathcal{I}(\Lambda)$. This situation is considered in Fig. (4.5).

As a last example we consider a convex mixture of exponential distributions, leading to Eq. (4.96) as well as

$$h(t) = \frac{\mu\lambda_1 e^{-\lambda_1 t} + (1 - \mu)\lambda_2 e^{-\lambda_2 t}}{\mu e^{-\lambda_1 t} + (1 - \mu) e^{-\lambda_2 t}}. \quad (4.119)$$

For this case, independently of the value of the mixing parameter μ , one has that both $\gamma(t)$ and $\delta(t)$ stay positive, so that the time-convolutionless master equation Eq. (4.105) has a time-dependent Lindblad structure, see Sec. (3.3.2). Once again both measures $\mathcal{N}(\Lambda)$ and $\mathcal{I}(\Lambda)$ give a zero value of non-Markovianity, despite the fact that the underlying waiting time distribution is not memoryless, corresponding to a population dynamics which can be associated with a non-Markovian classical process.

4.2.4 Different definitions of non-Markovianity for stochastic processes and state dynamics

Let us now make some conclusive remarks, which recall the main results presented in this chapter. We have analyzed the notion of non-Markovianity for the dynamics of open quantum systems, starting from the classical setting and focusing on concrete examples. While knowledge of a non-Markovian classical process requires information on all the conditional probability densities, when studying the dynamics of an open system one usually only considers the evolution of the state, expressed by a probability vector in the classical case and a statistical operator in the quantum case.

The notion of non-Markovianity for classical processes and for state dynamics are by necessity distinct concepts. One is then naturally led to the question whether and how the non-Markovianity of a process reflects itself in the behavior of the one-point probability. For processes which are Markovian according to the classical definition, both P-divisibility as well as a monotonic decrease, in time, of the Kolmogorov distance between states arising from different initial conditions are always obeyed. Therefore the lack of these properties can be interpreted as a signature of non-Markovianity, and can be used to quantify it. Note, however, that due to the fact that the classical definition of non-Markovianity actually involves all n -point probability densities, these signatures indeed provide a different notion of non-Markovianity, which only gives a sufficient condition in order to assess non-Markovianity in the original sense. This behavior has been shown by means of examples relying on the study of certain semi-Markov processes. We stress, in particular, that in the classical case P-divisibility is not equivalent to the Chapman-Kolmogorov equation. Such signatures of non-Markovianity can be brought over to the quantum framework, by considering the notion of CP-divisibility and of trace distance. These two criteria are at the basis of two recently introduced measures of non-Markovianity for open quantum systems [19, 20], which we have compared considering a quantum counterpart of classical semi-Markov processes.

Moreover, the analysis performed in this chapter clearly shows the importance of analyzing the dynamics of an open system by means of both integrodifferential and time local master equations. Once again, this is the case for classical as well as for quantum systems. On the one hand, the equivalence between the two descriptions, see also Sec. (3.1), gives a further evidence that the Markovianity of a stochastic process cannot be simply assessed through the equation of motion of its one-point probability distribution. On the other hand, one can point to possible signatures of non-Markovianity to be read directly at the level of the equation. In this respect it appears that the time local form of the equations, despite isolated singularities, is certainly more convenient.

In this chapter, we have discussed the different definitions of non-Markovianity relevant for classical stochastic processes and dynamical evolutions. While the latter can be directly considered both in the classical and the quantum case, it is not obvious how the original definition of non-Markovianity for a classical process can be transferred to the quantum realm, because of basic principles of quantum mechanics. First, to make statements about the value of a certain observables at different times, a measurement scheme has to be specified, which affects the subsequent time evolution; furthermore, the statistical operator of a quantum systems provide different, and generally incompatible, classical probability densities for different observables, as a typical feature of quantum probability with respect to classical probability [32, 34], see also Sec. (2.1.1). The possibility to define the notion of quantum stochastic processes in full analogy with the classical case has been investigated by means of C^* -algebras, see for example [130, 131]; this topic goes beyond the scope of this work.

It is clear that physical systems can provide us with much more complicated dynamics than those addressed in this chapter and the recent literature. The main aim of the discussed examples however was to consider realistic situations for which a thorough exact analysis is feasible, so as to allow a clarification of the conceptual issues related to the very definition of Markovianity and non-Markovianity, pointing in particular to the connection between classical and quantum situation.

Chapter 5

Initial correlations in the dynamics of open quantum systems

The entire description of the dynamics of open quantum systems performed so far relies on the assumption we introduced at the end of Chapter 2: the total initial state has been supposed to be a product state, i.e. of the form in Eq. (2.93), with a fixed environmental state. As follows from the discussion in Sec. (2.1.3), this corresponds to the hypothesis that the open system and the environment are initially prepared in a way such that no correlation between their statistics is introduced, and that the different states of the open system can be prepared retaining the same state of the environment. Starting from Eq. (2.93), we have been able to define one-parameter families of reduced dynamical maps, see Eq. (2.94), as well as *linear* equations of motion for the reduced statistical operator, being them integrodifferential, as in Eq. (3.17), or time-local, as in Eq. (3.18), see also Sec. (3.2). Indeed, any derivation of a Markovian reduced dynamics begins from the assumption that the total initial state is uncorrelated [1], see also Chapter 6.

Nevertheless, the assumption of a product total initial state is questionable in many circumstances, especially outside the weak coupling regime [22, 23, 24]. In concrete physical procedures, it is quite unlikely that one can actually prepare the open system without affecting the environment, or even without being perturbed by it, in particular if their mutual interaction is always present¹ and cannot be considered weak. Moreover, the hypothesis expressed in Eq. (2.93) assigns a very peculiar role to the initial time, being the subsequent dynamics characterized by the presence of correlations between the open system and its surrounding environment. Again, there are situations where this appears to be quite arbitrary, since it requires that two uncorrelated systems gets instantaneously coupled at some initial time.

For the same reasons, apart from the weak coupling regime [133, 134], the presence of correlations between the open system and the environment in the total initial state leads, in the subsequent reduced dynamics, to effects which cannot be neglected [135, 136, 137, 138, 139]. As further ex-

¹Note that a selective measurement, see Appendix A, of an observable of the open system associated with a non-degenerate self-adjoint operator actually prepares a product state. However, if the measurement is performed when the open system and the environment are correlated because of their earlier interaction, the state of the environment will be modified as well [132].

amples, the influence of initial correlations on dynamics of entanglement [140, 141] as well as on decoherence [142, 143, 144] has been pointed out. Thus, it turns out that the possibility to include initial correlations is of extreme relevance in order to give a realistic description of many physical systems.

In this chapter, we show how the approach to the dynamics of open quantum systems that is based on trace distance and that has been presented in the previous chapter, see also Appendix E, enables a quantitative characterization of the dynamics even in the presence of initial correlations between the open system and the environment. This does not require the definition of any reduced dynamical map, which in this case can be quite problematic, as will be discussed.

In the first section, we present some general methods to describe a reduced dynamics influenced by initial correlations. We start with a brief review of different approaches based on the use of maps on the state space of the open system. Contrary to the case of a product total initial state, the definition of these maps is non-unique and it requires the detection of a proper compatibility domain, which is not easy to be achieved explicitly. Outside such a domain, the reduced maps are in general not even positive, so that one has to go beyond the class of completely positive maps discussed in the previous chapters. Furthermore, we describe how the dynamics of open quantum systems with initial correlations can be fixed by a system of homogeneous equations of motion. This is accomplished by enlarging the set of dynamical variables from the reduced statistical operator $\rho_S(t)$ to a set of trace class operators, such that their sum equals $\rho_S(t)$. In particular, a well defined time evolution for any initial condition is guaranteed by introducing the so-called *generalized Lindblad structure* [145].

As already mentioned, we will focus on a different point of view, introduced in [26]. This extends the approach to open-system dynamics based on trace distance, which has been discussed in the previous chapter in order to assess the non-Markovianity of quantum dynamics. The comparison between two different reduced system states, $\rho_S^1(t)$ and $\rho_S^2(t)$, evolving from different total initial states, $\rho_{SE}^1(0)$ and $\rho_{SE}^2(0)$, allows us to describe the dynamics of the open system also in the presence of initial correlations, without the definition of any reduced map and without asking for any extra information related to the total system. We show that the trace distance $D(\rho_S^1(t), \rho_S^2(t))$ can increase above its initial value only because of different initial states of the environment or because of initial correlations. In any case, the evolution of $D(\rho_S^1(t), \rho_S^2(t))$ has an upper bound, which can be read in terms of an exchange of information between the open system and the environment. In the second section, we report the first experimental observation of an increase of trace distance above to its initial value due to initial system-environment correlations, recently realized at the University of Milan [27]. In our all-optical setting, the total system under investigation consists of a couple of photons generated by spontaneous parametric down conversion. After recalling some features of this non-linear optical phenomenon, we give the description of the experimental apparatus, in which initial correlations can be introduced in a very general way by means of a spatial light modulator. Finally, we present the theoretical characterization as well as the experimental data of the trace-distance evolution, clearly showing the effects of initial correlations.

In the third section, we come back to the Jaynes-Cummings model already considered in Sec. (3.2), but now we allow for fully generic total initial states. We analyze the influence of initial correlations on the subsequent dynamics of the open system by means of trace distance. First, we study, for a class of total initial states, when the upper bound previously introduced is actually reached

during the trace-distance evolution. Then, we examine the correlations contained in the thermal equilibrium state for the total system, analyze their dependence on the temperature and on the coupling strength, and demonstrate their connection to entanglement properties of the Hamiltonian eigenstates. The dynamics of the distinguishability of the open-system states evolving from the thermal equilibrium state and its corresponding uncorrelated product state shows that the open system dynamically uncovers typical features of the initial correlations.

5.1 Different descriptions of open-system dynamics in the presence of initial correlations

5.1.1 Reduced maps and assignment maps

We now want to briefly review how the description of reduced dynamics based on dynamical maps can be adapted to include possible initial system-environment correlations. Let us start with a simple example [146]. Consider a two qubits total system, one qubit regarded as the open system, the other one as the environment, with total Hamiltonian

$$H = \frac{1}{2}(I - \sigma_z) \otimes \sigma_x + \frac{1}{2}(I + \sigma_z) \otimes I, \quad (5.1)$$

such that $U = e^{-iHt} = I \cos t - iH \sin t$ realizes the C-NOT gate at $t = \pi/2$. Consider then two correlated total initial states

$$\begin{aligned} \rho_{SE}^1(0) &= |\alpha|^2|00\rangle\langle 00| + |\beta|^2|11\rangle\langle 11| \\ \rho_{SE}^2(0) &= (\alpha|00\rangle + \beta|11\rangle)(\alpha^*\langle 00| + \beta^*\langle 11|) \end{aligned} \quad (5.2)$$

sharing both the marginal states, i.e., $\rho_S^1(0) = \rho_S^2(0) = |\alpha|^2|0\rangle\langle 0| + |\beta|^2|1\rangle\langle 1|$ and $\rho_E^1(0) = \rho_E^2(0) = |\alpha|^2|0\rangle\langle 0| + |\beta|^2|1\rangle\langle 1|$. They differ only because of correlations. The two total initial states in Eq. (5.2) evolve at time $t = \pi/2$ into two different states, so that also the corresponding reduced states are different:

$$\begin{aligned} \rho_S^1(t = \pi/2) &= |\alpha|^2|0\rangle\langle 0| + |\beta|^2|1\rangle\langle 1| \\ \rho_S^2(t = \pi/2) &= (\alpha|0\rangle + \beta|1\rangle)(\alpha^*\langle 0| + \beta^*\langle 1|). \end{aligned} \quad (5.3)$$

Depending on its initial correlations with the environment, the open system can evolve into different states even if, in both cases, it is initially in the same state. Thus, how can one define a dynamical map on the state space of the open system which associates to *any* reduced initial state $\rho_S(0)$ *only one* state $\rho_S(t)$ at time t ? Indeed, a fully analogous question could arise for product total initial states: one can easily figure out an example where two total initial states with the same reduced state, $\rho_S(0) \otimes \rho_E^1(0)$ and $\rho_S(0) \otimes \rho_E^2(0)$, with $\rho_E^1(0) \neq \rho_E^2(0)$, evolve at time t into two different states such that $\rho_S^1(t) \neq \rho_S^2(t)$. But in this case the problem can be solved very easily: a unique family of reduced dynamical maps, which in addition are also completely positive, is defined by fixing the state of the environment, see Eqs. (2.94) and (2.95). The mathematical as well as the physical meaning of such a prescription is clear.

In order to proceed in a similar way also in the presence of initial correlations between the system and the environment, one can introduce reduced maps for fixed correlations [146]. Let us decompose the total initial state $\rho_{SE}(0)$ as

$$\begin{aligned}\rho_{SE}(0) &= \frac{1}{NM} \left(\mathbb{1}_{SE} + \sum_{n=1}^{N^2-1} \alpha_n(0) \sigma_n \otimes \mathbb{1}_E + \sum_{m=1}^{M^2-1} \beta_m(0) \mathbb{1}_S \otimes \tau_m + \sum_{n=1}^{N^2-1} \sum_{m=1}^{M^2-1} \gamma_{nm}(0) \sigma_n \otimes \tau_m \right) \\ &= \rho_S(0) \otimes \rho_E(0) + \sum_{n=1}^{N^2-1} \sum_{m=1}^{M^2-1} g_{nm}(0) \sigma_n \otimes \tau_m,\end{aligned}\quad (5.4)$$

where N and M are the finite dimensions of the Hilbert spaces associated with, respectively, the open system and the environment, and both the bases of linear maps, $\{\sigma_n\}_{n=0, \dots, N^2-1}$ on $\mathcal{L}(\mathbb{C}^N)$ and $\{\tau_m\}_{m=0, \dots, M^2-1}$ on $\mathcal{L}(\mathbb{C}^M)$, satisfy Eq. (3.34). The reduced initial state is then $\rho_S(0) = (\mathbb{1}_S + \sum_n \alpha_n(0) \sigma_n)/N$ and the initial state of the environment is $\rho_E(0) = (\mathbb{1}_E + \sum_m \beta_m(0) \tau_m)/M$, while the initial system-environment correlations are characterized by the parameters

$$g_{nm}(0) = \frac{\gamma_{nm}(0) - \alpha_n(0)\beta_m(0)}{NM} = \langle \sigma_n \otimes \tau_m \rangle - \langle \sigma_n \rangle \langle \tau_m \rangle, \quad (5.5)$$

with $n = 1, \dots, N^2 - 1$ and $m = 1, \dots, M^2 - 1$. Replacing Eq. (5.4) into Eq. (2.91), one gets

$$\rho_S(t) = \sum_{kk'} M_{kk'}(t, 0) \rho_S(0) M_{kk'}^\dagger(t, 0) + \sum_{knm} g_{nm}(0) \langle u_k | U(t, 0) \sigma_n \otimes \tau_m U^\dagger(t, 0) | u_k \rangle \quad (5.6)$$

with $M_{kk'}(t, 0)$ given by Eq. (2.96), where the eigenvalues $p_{k'}$ and the eigenvectors $|v_{k'}\rangle$ of the environmental initial state appear. The first term corresponds to the Kraus decomposition which provides a completely positive map when there are no initial correlations, see Eq. (2.95), and the state of the environment is fixed. If, in addition, one fixes the correlation parameters $g_{nm}(0)$, that is the inhomogeneous term, then Eq. (5.6) defines an *affine*² reduced map. Note that we are here introducing a different reduced map for any set of fixed correlation parameters³. The crucial point is that, for initial non-zero correlations, a reduced map can be consistently derived from the total unitary dynamics only on a subset of all the possible reduced statistical operators, the so-called *compatibility domain* [148]. Contrary to what happens for a product total initial state $\rho_S(0) \otimes \rho_E(0)$, if there are non-zero correlation parameters $g_{nm}(0)$, then not every choice of the reduced initial state $\rho_S(0)$ is compatible with a well-defined total initial state $\rho_{SE}(0)$. A paradigmatic example is given by reduced pure states, i.e., $\rho_S(0) = |\psi\rangle\langle\psi|$. In fact, a reduced state of a bipartite system is pure only if the total state is a product state, see Sec. (2.1.3). This means that if a pure state is replaced in Eq. (5.4) with $g_{nm}(0) \neq 0$ for some n and m , the resulting $\rho_{SE}(0)$ is not a statistical operator. The compatibility domain is precisely formed by those states

²An affine map on the set of statistical operator can always be rewritten as a linear map [49, 147].

³Depending on the explicit form of the unitary evolution $U(t, 0)$ there can be correlation parameters which does not affect this definition of the reduced maps; namely, those $g_{nm}(0)$ associated with $\sum_k \langle u_k | U(t, 0) \sigma_n \otimes \tau_m U^\dagger(t, 0) | u_k \rangle = 0$ in Eq. (5.6). In this case, different total initial states $\rho_{SE}^k(0)$ that correspond to the same reduced initial state $\rho_S(0)$ evolve into possibly different final states $\rho_{SE}^k(t)$, but with the same reduced state $\rho_S(t)$.

which are compatible with the correlations fixed in the total initial state. Outside the compatibility domain, the physical meaning of the reduced map is lost and, in fact, a reduced statistical operator can be mapped to an operator which is not a well-defined state since it is not positive definite. The reduced maps introduced in the presence of initial correlations are generally not positive and, of course, not completely positive either. It has been proved [149] that if the total initial state has zero discord, see Sec.(2.1.3), then it is always possible, for an arbitrary unitary evolution $U(t, 0)$, to define a family of completely positive reduced dynamical maps. Indeed, also in this case the physical meaning of the map in connection with the total unitary dynamics is established only inside its compatibility domain. To explicitly determine such a domain is then in any case a necessary step in order to give a significative description of the reduced dynamics; however this is in general a very complicated mathematical task. Even more importantly, the reduced maps crucially depend on quantities related to the total system which can be hardly achievable in many concrete physical settings.

As a further remark, note that the procedure now presented is highly non-unique. For example, one can define a reduced map by fixing the mean values $\langle \sigma_n \otimes \tau_m \rangle$, for $n = 0, \dots, N^2 - 1$ and $m = 1, \dots, M^2 - 1$, instead of the correlations [148, 150]. The reduced maps defined by fixing, respectively, the mean values and the correlations have different compatibility domains and, moreover, they generally map reduced states which are in both their compatibility domains into different final states [25]: the reduced dynamics they describe are not equivalent. A third way to proceed has been introduced in [151, 152]. Here, the total initial state is expanded as

$$\rho_{SE}(0) = \sum_{ij=1}^N \varrho_{ij}(0) |u_i\rangle\langle u_j| \otimes \phi_{ij}, \quad (5.7)$$

with $\varrho_{ij}(0) = \varrho_{jk}^*(0)$, $\phi_{ij} = \phi_{ji}^\dagger$, and $\sum_i \varrho_{ii} = 1$. It has been proved [151] that, starting from the expansion in Eq. (5.7), one can introduce a class of reduced hermitian linear maps such that a vanishing discord in the total initial state is, beside a sufficient, also a necessary condition in order to have complete positivity for an arbitrary unitary evolution⁴ $U(t, 0)$.

Finally, let us mention that a complementary approach is based on *assignment maps* [22, 23]. This approach can be simply illustrated by means of the following diagram:

$$\begin{array}{ccc} \rho_{SE}(0) & \longrightarrow & \rho_{SE}(t) \\ \text{tr}_E \downarrow \uparrow \mathcal{A} & & \text{tr}_E \downarrow \\ \rho_S(0) & \longrightarrow & \rho_S(t). \end{array} \quad (5.8)$$

The map \mathcal{A} , which connects the reduced initial state $\rho_S(0)$ to one total initial state $\rho_{SE}(0)$, is just the assignment map. This represents how the preparation procedure, which prepares the open system in the state $\rho_S(0)$, affects the total initial state as well [23, 154]. The composition of three

⁴Note that for a fixed unitary evolution one can have completely positive reduced dynamical maps even for more general class of initial total states. As a peculiar example, it has been proved [153] that one can introduce completely positive reduced dynamical maps for an *arbitrary* initial total state if (and only if) the overall unitary evolution is locally unitary, i.e. $U(t, 0) = U_S(t, 0) \otimes U_E(t, 0)$.

maps, $\text{tr}_E \circ U(t, 0) \circ \mathcal{A}$, gives then the reduced map, connecting the initial state $\rho_S(0)$ to the state $\rho_S(t)$ at time t . Indeed, there are different non-equivalent ways to define an assignment map and, consequently, a reduced dynamics. It has been shown [22] that the "trivial" assignment map

$$\begin{aligned} \mathcal{A} : \mathcal{S}(\mathcal{H}_S) &\rightarrow \mathcal{S}(\mathcal{H}_{SE}) \\ \rho_S(0) &\rightarrow \mathcal{A}\rho_S(0) = \rho_S(0) \otimes \rho_E, \end{aligned} \quad (5.9)$$

with a fixed environmental state ρ_E , is the only assignment map which associates to any reduced state $\rho_S(0)$ a well-defined total state $\rho_{SE}(0)$ and which is linear and consistent, i.e. such that $\text{tr}_E[\mathcal{A}\rho_S(0)] = \rho_S(0)$. Thus, it turns out that in order to describe reduced dynamics in the presence of initial correlations, one has to resort to non-linear [23, 24, 155], non-consistent [23, 156] or non-positive [157, 156] assignment maps. In particular, let us note that the approaches based on the definition of a compatibility domain can be read as the realization of a specific assignment map. For example, if the initial correlation parameters $g_{nm}(0)$ as well as the environmental initial state $\rho_E(0)$ are fixed, Eq. (5.4) naturally defines an assignment map. From the previous discussion, it is then clear that we are here in the case of a non-positive assignment map, since the image of a state $\rho_S(0)$ outside the compatibility domain is not a well-defined total state [157, 158].

5.1.2 Generalized Lindblad structure

In the presence of initial system-environment correlations, the dynamics of open quantum systems can be also described by means of master equations, which are typically inhomogeneous, explicitly depending on the initial state of the total system. We have given an example of such inhomogeneous equations in Sec. (3.1.1), where we employed projection operator techniques to derive local as well as non-local master equations from the full unitary dynamics of the total system, see Eqs. (3.8) and (3.14). Furthermore, one can directly obtain an inhomogeneous master equation from the affine map defined in Eq. (5.6), as shown in [146]. In this paragraph, we present an alternative way to characterize open-system dynamics with initial correlations, consisting in a system of homogeneous equations of motion [145], referred to as *generalized Lindblad structure*. This has been introduced within the context of a generalization of projection operator techniques, relying on the use of correlated projection operators. In the next chapter, we will see how it naturally applies to the case of a bipartite open system, as well.

In the presence of initial correlations between the open system and the environment, the master equations derived by means of the projection operator techniques introduced in Sec. (3.1.1) are inhomogeneous and they explicitly depend on the initial state of the total system, see Eqs. (3.8) and (3.14). Nevertheless, this is strictly connected to the choice of the projection operator P in Eq. (3.2), that projects the total state ρ_{SE} into the product state $\rho_S \otimes \rho_E$. One can in fact employ a more general class of projection operators [159, 160, 161, 162] that project the total state ρ_{SE} into a correlated, typically a separable, state. This yields a description of reduced dynamics in terms of homogeneous master equations, even in the presence of initial correlations [163]. Consider, for

example, an initial total state of the form

$$\rho_{SE}(0) = \sum_{k=1}^N \rho_k(0) \otimes \sigma_k, \quad (5.10)$$

where $\rho_k(0)$ and σ_k are trace class positive operators on, respectively, \mathcal{H}_S and \mathcal{H}_E , and there is a family of projection operators $\{\Pi_k\}_{k=1,\dots,N}$ on \mathcal{H}_E satisfying $\Pi_k \Pi_j = \delta_{kj} \Pi_k$ and $\sum_k \Pi_k = \mathbb{1}_E$, such that

$$\begin{aligned} \rho_k(0) &= \text{tr}_E[\Pi_k \rho_{SE}(0)] \\ \sigma_k &= \frac{\Pi_k \sigma_E \Pi_k}{\text{tr}_E[\Pi_k \sigma_E]}, \end{aligned} \quad (5.11)$$

for some reference environmental state σ_E . Note that if the Π_k are one dimensional projectors, then $\rho_{SE}(0)$ in Eq. (5.10) is a state with a vanishing discord with respect to measurements on the environment, see Eq. (2.29). Such an initial condition can be typically related to the case of an open system interacting with a structured environment [164, 160, 145]. It is then clear that the inhomogeneous term in Eq. (3.14) is equal to zero if one introduces a projection operator of the form

$$\rho_{SE} \mapsto P\rho_{SE} = \sum_k \rho_k \otimes \sigma_k, \quad (5.12)$$

where $\rho_k = \text{tr}_E[\Pi_k \rho_{SE}]$ and σ_k as in Eq. (5.11), so that $P\rho_{SE}(0) = \rho_{SE}(0)$ and then $Q\rho_{SE}(0) = 0$. The latter relation can be expressed by saying that, due to the projection operator introduced, the irrelevant part of the initial total state is equal to zero. Moreover, the time-local master equation in Eq. (3.14) generates a system of equations of the form

$$\frac{d}{dt} \rho_k(t) = K_k(t) (\rho_1(t), \dots, \rho_N(t)) \quad (5.13)$$

for the collection of trace class operators $\rho_k(t)$, defined as

$$\rho_k(t) = \text{tr}_E[\Pi_k \rho_{SE}(t)]. \quad (5.14)$$

These represent supplementary dynamical variables allowing to include the effects of system-environment correlations into the description of the reduced dynamics. In fact, from the knowledge of the entire collection $\{\rho_k(t)\}_{k=1,\dots,N}$, one can reconstruct the state of the open system at time t as

$$\rho_S(t) = \sum_k \rho_k(t). \quad (5.15)$$

It is worth emphasizing that, in general, the system of equations in Eq. (5.13) does *not* define a family of reduced dynamical maps, each associating to any initial reduced state $\rho_S(0)$ the corresponding state $\rho_S(t)$ at a time t . In fact, in order to determine the state $\rho_S(t)$, one needs for the entire collection of initial trace class operators $\{\rho_k(0)\}_{k=1,\dots,N}$: only from the knowledge of such a collection the system of equations into Eq. (5.13) provides the collection $\{\rho_k(t)\}_{k=1,\dots,N}$

at time t and therefore, through Eq. (5.15), also $\rho_S(t)$. This can be summarized by the following non-commutative diagram [165]:

$$\begin{array}{ccc}
 (\rho_1(0), \rho_2(0), \dots, \rho_N(0)) & \longrightarrow & (\rho_1(t), \rho_2(t), \dots, \rho_N(t)) \\
 \downarrow & & \downarrow \\
 \rho_S(0) = \sum_k \rho_k(0) & \longmapsto & \rho_S(t) = \sum_k \rho_k(t).
 \end{array} \quad (5.16)$$

The transition from the collection $\{\rho_k(0)\}_{k=1,\dots,N}$ to the reduced state $\rho(0)$ through Eq. (5.15) can be seen as a loss of information on initial correlations, so that from the knowledge of $\rho(0)$ the dynamical behavior of the reduced system cannot be reconstructed [145]. As we will explicitly see in the next chapter for a specific case, if the initial total state $\rho_{SE}(0)$ is uncorrelated, that is

$$\rho_k(0) = p_k \rho_S(0), \quad (5.17)$$

with $p_k := \text{tr}_E[\Pi_k \rho_E(0)]$, then the evolution of the collection $\{\rho_k(t)\}_{k=1,\dots,N}$ directly leads to the introduction of a one-parameter family of dynamical maps.

Indeed, given a generic system of equations as in Eq. (5.13), introduced, e.g., on the basis of a perturbative expansion or a phenomenological ansatz, one has no warranty that the consequent dynamics is well defined, i.e., that the reduced state $\rho_S(t)$ determined through Eq. (5.15) is positive for any initial collection $\{\rho_k(0)\}_{k=1,\dots,N}$. However, one can introduce a class of such system of equations that preserves the positivity of $\rho_S(t)$ and, even more, preserves the positivity of each trace class operator $\rho_k(t)$ [145]. Consider an auxiliary Hilbert space \mathbb{C}^N and a fixed basis $\{|u_k\rangle\}_{k=1,\dots,N}$ on \mathbb{C}^N . Then, the collections $\{\rho_k(t)\}_{k=1,\dots,N}$ are in one-to-one correspondence with block diagonal trace class operators on the extended Hilbert space $\mathcal{H}_S \otimes \mathbb{C}^N$, of the form

$$\rho(t) = \sum_k \rho_k(t) \otimes |u_k\rangle\langle u_k|. \quad (5.18)$$

Now, if we further assume that there exists a Lindblad generator L on the extended space which also preserves the block diagonal structure, i.e.,

$$L\left[\sum_k \rho_k(t) \otimes |u_k\rangle\langle u_k|\right] = \sum_k K_k(\rho_1(t), \dots, \rho_N(t)) \otimes |u_k\rangle\langle u_k|, \quad (5.19)$$

then the positivity of each $\rho_k(t)$ at any time t is guaranteed. In fact, because of Eq. (5.19), the trace class operators $\rho_k(t)$ are fixed by completely positive semigroup evolution, according to

$$\sum_k \rho_k(t) \otimes |u_k\rangle\langle u_k| = e^{Lt} \left[\sum_k \rho_k(0) \otimes |u_k\rangle\langle u_k| \right]. \quad (5.20)$$

Note that we are here considering generators $K_k(\rho_1(t), \dots, \rho_N(t))$ that do not depend on time. One can prove [145] that there exists a Lindblad structure L on the extended Hilbert space $\mathcal{H}_S \otimes$

\mathbb{C}^N such that Eq. (5.19) is satisfied if and only if the generators K_k define through Eq. (5.13) the following system of equations

$$\frac{d}{dt}\rho_k(t) = -i[H^k, \rho_k(t)] + \sum_{j\lambda} \left(R_\lambda^{kj} \rho_j(t) R_\lambda^{kj\dagger} - \frac{1}{2} \left\{ R_\lambda^{jk\dagger} R_\lambda^{jk}, \rho_k(t) \right\} \right), \quad (5.21)$$

with Hermitian operators H^k and arbitrary open-system linear operators R_λ^{kj} . This is usually referred to as generalized Lindblad structure. Note, in fact, that if the collection $\{\rho_k(t)\}_{k=1,\dots,N}$ is formed by a single element $\rho_1(t) = \rho_S(t)$, then Eq. (5.21) reduces to a Lindblad equation, which then represents a very peculiar special case. As will be explicitly shown in the next chapter, the generalized Lindblad structure usually describes dynamics that present highly non-Markovian behavior. By looking at the time evolution of $\rho_S(t)$ only, one is considering a restricted set of variables with respect to the full collection $\{\rho_k(t)\}_{k=1,\dots,N}$ for which the time evolution would be Markovian. The set of relevant physical variables then determines whether or not the dynamics is Markovian. As well-known in the classical case [102], the same physical process can be associated with a non-Markovian or a Markovian dynamics, depending on the dynamical variables that are actually used to describe it.

In conclusion, the system of equations in Eq. (5.21) provides a reference structure to characterize dynamics of open quantum systems in the presence of initial correlations as well as strongly non-Markovian effects. Given a generalized Lindblad structure, one can always equivalently see it as a Lindblad structure restricted to block diagonal states on an extended Hilbert space. On the one hand, this guarantees that the subsequent evolution is well defined and, in particular, that positivity is preserved. On the other hand, it allows to give a description of the resulting dynamics in terms of measurements in continuous time [166], generalizing the well-established approach for quantum dynamical semigroups [167]. In the next chapter, we will show how a generalized Lindblad structure naturally appears on a bipartite open system evolving through a semigroup dynamics, whenever one of its two subsystems is not resolved during measurements, thus becoming part of the environment.

5.1.3 Trace-distance analysis of reduced dynamics with initial correlations

In the rest of the chapter, we shall follow an entirely different strategy, recently introduced in [26], to analyze the role of initial system-environment correlations in the subsequent dynamics of the open system. Namely, we will investigate the evolution of the trace distance $D(\rho_S^1(t), \rho_S^2(t))$ between a pair of states $\rho_S^1(t)$ and $\rho_S^2(t)$ of the open system, that evolve from a given pair of initial states $\rho_{SE}^1(0)$ and $\rho_{SE}^2(0)$ of the total system. Let us emphasize that in this way we will be able to characterize the reduced-system dynamics in a quantitative way, without the need for any prior knowledge about the environmental state or the system-environment correlations at initial time. In concrete situations, a full experimental control of the total system is hardly ever available, so that it is indeed an advantage of the present approach to yield a description of the reduced dynamics only in terms of quantities that are experimentally accessible through local measurements on the open system.

Consider any two total initial states $\rho_{SE}^1(0)$ and $\rho_{SE}^2(0)$, and the corresponding open system states

$\rho_S^1(t)$ and $\rho_S^2(t)$ at time t . According to Eq. (2.92), the latter are given by $\rho_S^1(t) = \Upsilon(t, 0)\rho_{SE}^1(0)$ and $\rho_S^2(t) = \Upsilon(t, 0)\rho_{SE}^2(0)$, where $\Upsilon(t, 0)$ is a linear, trace preserving and completely positive map from the set of states of the total system to the set of states of the open system. Since the trace distance is contractive for CPT maps, see Appendix C, we obtain a bound for the trace distance between the reduced system states,

$$D(\rho_S^1(t), \rho_S^2(t)) \leq D(\rho_{SE}^1(0), \rho_{SE}^2(0)). \quad (5.22)$$

If the total initial states are uncorrelated with the same environmental state $\rho_E(0)$, that is $\rho_{SE}^1(0) = \rho_S^1(0) \otimes \rho_E(0)$ and $\rho_{SE}^2(0) = \rho_S^2(0) \otimes \rho_E(0)$, this inequality reduces, with the help of Eq. (C.8), to

$$D(\rho_S^1(t), \rho_S^2(t)) \leq D(\rho_S^1(0), \rho_S^2(0)). \quad (5.23)$$

For initially uncorrelated total system states and identical environmental states a CPT map on the whole set of *reduced* states can be always introduced: Eq. (5.23) simply represents the contraction property for the dynamical map defined in Eq. (2.94). In this case the trace distance between reduced system states at time t can never be larger than its initial value. The total amount of information flowing back from the environment to the system is upper bounded by the total amount of information earlier flowed out from the system since the initial time.

Coming back to the general case, the inequality in Eq. (5.22) may be written as

$$\begin{aligned} & D(\rho_S^1(t), \rho_S^2(t)) - D(\rho_S^1(0), \rho_S^2(0)) \\ & \leq D(\rho_{SE}^1(0), \rho_{SE}^2(0)) - D(\rho_S^1(0), \rho_S^2(0)) \equiv I(\rho_{SE}^1(0), \rho_{SE}^2(0)). \end{aligned} \quad (5.24)$$

According to this inequality the change of the trace distance of the open system states is bounded from above by the quantity $I(\rho_{SE}^1(0), \rho_{SE}^2(0)) \geq 0$. This quantity represents the distinguishability of the total initial states minus the distinguishability of the corresponding reduced initial states. Thus, $I(\rho_{SE}^1(0), \rho_{SE}^2(0))$ can be interpreted as the *relative*⁵ information of the total initial states which is initially outside the open system, i.e., which is inaccessible for local measurement performed on the open system [26]. Therefore, Eq. (5.24) states that the maximal amount of information that can flow back to the open system equals the amount of information flowed out earlier plus the information which is initially outside the open system. Indeed, Eq. (C.8) implies that if $\rho_{SE}^1(0) = \rho_S^1(0) \otimes \rho_E(0)$ and $\rho_{SE}^2(0) = \rho_S^2(0) \otimes \rho_E(0)$, then $I(\rho_{SE}^1(0), \rho_{SE}^2(0)) = 0$. On the other hand, for $I(\rho_{SE}^1(0), \rho_{SE}^2(0)) > 0$ the trace distance of the open system states can increase over its initial value. This increase can be interpreted by saying that information which is initially outside the open system flows back to the system and becomes accessible through local measurements. Note that, as will be illustrated by means of several examples below, the bound for the dynamics of trace distance given by Eq. (5.24) is tight, i.e., it can be reached for certain total initial states. If the bound of the inequality in Eq. (5.24) is actually reached at some time t , the initial distinguishability of the total system states is equal to the distinguishability of the open system states at time t . This means that the relative information on the total initial states has been dynamically transferred completely to the open system [26].

⁵We emphasize that the information as described by means of trace distance has to be understood as a relative information, since it is accessed through the comparison of two different states.

Using the sub-additivity of the trace distance (C.7) and the triangular inequality (C.5) one deduces from Eq. (5.24) the following inequality [26],

$$\begin{aligned} D(\rho_S^1(t), \rho_S^2(t)) - D(\rho_S^1(0), \rho_S^2(0)) \\ \leq D(\rho_{SE}^1(0), \rho_S^1(0) \otimes \rho_E^1(0)) + D(\rho_{SE}^2(0), \rho_S^2(0) \otimes \rho_E^2(0)) + D(\rho_E^1(0), \rho_E^2(0)). \end{aligned} \quad (5.25)$$

For any state ρ_{SE} the quantity $D(\rho_{SE}, \rho_S \otimes \rho_E)$ describes how well ρ_{SE} can be distinguished from the fully uncorrelated product state $\rho_S \otimes \rho_E$ of its marginal states ρ_S and ρ_E . Thus, $D(\rho_{SE}, \rho_S \otimes \rho_E)$ can be interpreted as a measure for the total amount of correlations in the state ρ_{SE} . Therefore, the inequality in Eq. (5.25) shows that an increase of the trace distance of the open system states over its initial value implies that there must be correlations in the initial states $\rho_{SE}^1(0)$ or $\rho_{SE}^2(0)$, or that the environmental states are different. An important special case, which will be considered in detail, occurs if $\rho_{SE}^2(0)$ is given by the product state obtained from the marginals of $\rho_{SE}^1(0)$, i.e., $\rho_{SE}^2(0) = \rho_S^1(0) \otimes \rho_E^1(0)$. The inequality in Eq. (5.24) then reduces to the simple form

$$D(\rho_S^1(t), \rho_S^2(t)) \leq D(\rho_{SE}^1(0), \rho_S^1(0) \otimes \rho_E^1(0)), \quad (5.26)$$

according to which the increase of trace distance is bounded by the amount of correlations in the total initial state.

In the following, we will be interested mainly in the effects of initial correlations on the dynamics of open systems, as described by the trace distance $D(\rho_S^1(t), \rho_S^2(t))$ between two different reduced states evolved from different total initial states, $\rho_{SE}^1(0)$ and $\rho_{SE}^2(0)$. Nevertheless, the above mentioned approach also allows to develop experimental methods which access some global information about a *single* fully unknown initial state $\rho_{SE}^1(0)$, by means of measurement on the reduced system only. For example, one can witness system-environment correlations [26] in $\rho_{SE}^1(0)$ by preparing a second state $\rho_{SE}^2(0)$ through a trace preserving local operation, i.e., according to

$$\rho_{SE}^2(0) = (\Sigma \otimes \mathbb{1}) \rho_{SE}^1(0). \quad (5.27)$$

In this way, the two states, $\rho_{SE}^1(0)$ and $\rho_{SE}^2(0)$, have the same environmental marginal state and if $\rho_{SE}^1(0)$ is a product state, then so $\rho_{SE}^2(0)$ is. This means that an increase of the trace distance $D(\rho_S^1(t), \rho_S^2(t))$ over its initial value indicates that the original total state $\rho_{SE}^1(0)$ is correlated. It is important to note that this strategy can be improved in order to discriminate between classical and quantum correlations in the total state $\rho_{SE}^1(0)$, see [168].

5.2 Experimental investigation

In this section, we provide an experimental proof of the feasibility and effectiveness of the above mentioned theoretical scheme for observing the effect of initial system-environment correlations in the subsequent open system dynamics by means of trace distance. In particular, for a fixed initial state of the environment, we show an increase of the trace distance between two reduced states over its initial value on both short and long time scales. In our all-optical apparatus the open system under investigation consists in the entangled polarization degrees of freedom of a

two-photon state produced by spontaneous parametric downconversion (SPDC). The material of this section is for the most part contained in [27]. Note that in [169] initial correlations between the polarization and the spectral degrees of freedom of single photon states, which are due to a linear phase between horizontal and vertical polarization, are experimentally witnessed by means of trace distance.

5.2.1 Spontaneous parametric downconversion

We now briefly review some few aspects connected with SPDC that will be useful in the following in order to properly specify the two-photon states under investigation; the reader is referred to [170] for an exhaustive presentation of the topic. An electric field \mathbf{E} in a nonlinear crystal induces a polarization \mathbf{P} , with components

$$P_j(\mathbf{r}) = \epsilon_0 \sum_k \chi_{jk}^{(1)} E_k(\mathbf{r}) + \epsilon_0 \sum_{kl} \chi_{jkl}^{(2)} E_k(\mathbf{r}) E_l(\mathbf{r}) + \dots, \quad (5.28)$$

where ϵ_0 is the electric constant and $\chi^{(\alpha)}$, $\alpha = 1, 2, \dots$, is the α -th order susceptibility tensor. Working in the interaction picture, the lowest order nonlinear term gives a contribution to the system's Hamiltonian of the form

$$H_I^{(2)}(t) = \frac{1}{2} \int d^3\mathbf{r} \mathbf{P}^{(2)}(\mathbf{r}, t) \cdot \mathbf{E}(\mathbf{r}, t) = \frac{\epsilon_0}{2} \sum_{jkl} \int d^3\mathbf{r} \chi_{jkl}^{(2)} E_j(\mathbf{r}, t) E_k(\mathbf{r}, t) E_l(\mathbf{r}, t). \quad (5.29)$$

The interaction term involves three electric fields: one is associated with the incident electric field and it is usually treated as a classical field, while the other two, called *signal* and *idler*, are generated in the non linear process inside the crystal and they are treated as quantum fields. In a uniaxial crystal, a linearly polarized electric field has unequal indices of refraction according to the relation between its polarization and the optical axis of the crystal. If the polarization is parallel to the plane containing the optical axis and the direction of propagation of the field, then the electric field is said to be *extraordinary* and its index of refraction is indicated as n_e . While if the polarization is orthogonal to such plane, the electric field is *ordinary*, with index of refraction n_o . In the following, we will consider in particular the so-called type-I parametric down conversion, where the incident electric field is extraordinary, while both the signal and the idler are ordinary. Assuming that the incident electric field consists in a laser propagating in the \hat{z} -direction of the coordinate system and indicating as \hat{e} and \hat{o} the extraordinary and the ordinary polarization vector, respectively, the Hamiltonian term in Eq. (5.29) reads [171]

$$\begin{aligned} H_I^{(2)}(t) &= \int_0^\infty d\omega_p \int d\mathbf{k}_s d\mathbf{k}_i \chi_{\text{eff}}(\omega_s, \omega_i, \omega_p) A(\omega_p) e^{i(\omega_s + \omega_i - \omega_p)t} \\ &\times \int_{-\infty}^\infty dx \int_{-\infty}^\infty dy \int_{-L/2}^{L/2} dz e^{i(\mathbf{k}_p - \mathbf{k}_s - \mathbf{k}_i) \cdot \mathbf{r}} a_{\mathbf{k}_s, \hat{o}}^\dagger a_{\mathbf{k}_i, \hat{o}}^\dagger + \text{h. c.}, \end{aligned} \quad (5.30)$$

where $A(\omega_p)$ is the amplitude of the incident field, $\omega_s = c|\mathbf{k}_s|/n_o(\mathbf{k}_s)$, $\omega_i = c|\mathbf{k}_i|/n_o(\mathbf{k}_i)$, $\mathbf{k}_p = (\omega_p n_e(\omega_p)/c) \hat{z}$ and $a_{\mathbf{k}_s, \hat{o}}^\dagger$ ($a_{\mathbf{k}_i, \hat{o}}^\dagger$) is the creation operator of the mode of the signal (idler)

characterized by momentum \mathbf{k}_s (\mathbf{k}_i) and polarization $\hat{o}(\mathbf{k}_s)$ ($\hat{o}(\mathbf{k}_i)$). Moreover, we introduced the effective susceptibility

$$\chi_{\text{eff}}(\omega_s, \omega_i, \omega_p) = -\frac{i\omega_p^{5/2} n_e^2(\omega_p) (\hbar^3 \omega_s \omega_i)^{1/2}}{2\pi^2 c^3 n_o(\omega_s) n_o(\omega_i)} \sum_{jkl} \chi_{jkl}^{(2)} \hat{e}_j \hat{o}_k(\mathbf{k}_s) \hat{o}_l(\mathbf{k}_i), \quad (5.31)$$

where we included the normalization terms of the fields as well as the susceptibility tensor components and the polarizations. Note that we have taken into account the finite size L of the crystal along the direction of propagation of the laser, while we could neglect the same effect on the transverse direction⁶. By integrating over the spatial variables, we obtain

$$\begin{aligned} H_I^{(2)}(t) &= \int_0^\infty d\omega_p \int d\mathbf{k}_s d\mathbf{k}_i \chi_{\text{eff}}(\omega_s, \omega_i, \omega_p) A(\omega_p) e^{i(\omega_s + \omega_i - \omega_p)t} \\ &\quad \times L \text{sinc}\left(\frac{L}{2\pi} \Delta k_{\parallel}\right) \delta(\Delta k_{\perp}) a_{\mathbf{k}_s, \hat{o}}^\dagger a_{\mathbf{k}_i, \hat{o}}^\dagger + \text{h. c.}, \end{aligned} \quad (5.32)$$

where $\text{sinc}(x) = \sin(\pi x)/(\pi x)$. The δ -function represents the exact conservation of the transverse component of the momentum, where $\delta(\Delta k_{\perp}) = \delta(k_{x,s} + k_{x,i}) \delta(k_{y,s} + k_{y,i})$, while the sinc-function is due to the finite size of the crystal along the longitudinal direction, where $\Delta k_{\parallel} = k_{z,s} + k_{z,i} - k_p$. The conditions expressed by momentum conservation are often referred to as *phase matching* conditions. In *spontaneous* parametric down conversion, the signal and the idler are supposed to be initially in the vacuum state, so that to first order approximation the interaction described by Eq. (5.32) generates a superposition of the vacuum state and a two-photon state $|\psi\rangle$ given by

$$\begin{aligned} |\psi\rangle &= \int_0^\infty d\omega_p \int d\mathbf{k}_p d\mathbf{k}_s \chi_{\text{eff}}(\omega_s, \omega_p - \omega_s, \omega_p) A(\omega_p) \\ &\quad \times L \text{sinc}\left(\frac{L}{2\pi} \Delta k_{\parallel}\right) \delta(\Delta k_{\perp}) |\hat{o}(\mathbf{k}_s), \mathbf{k}_s\rangle |\hat{o}(\mathbf{k}_i), \mathbf{k}_i\rangle, \end{aligned} \quad (5.33)$$

where we exploited the frequency δ -function that is obtained by integrating over the time variable and that expresses the energy conservation, i.e. $\omega_i = \omega_p - \omega_s$.

Now, assume that the amplitude of the laser is centered around a frequency ω_p^0 , while the signal and the idler are revealed through two apertures of small size in the \hat{y} -direction and with angular openings $\Delta\theta_s$ and $\Delta\theta_i$ in the $x - z$ plane, centered around θ_s^0 and θ_i^0 , respectively; see Fig.(5.1). The phase matching condition determines, in correspondence with the central directions of the signal and the idler, the central frequencies ω_s^0 and $\omega_i^0 = \omega_p^0 - \omega_s^0$. Furthermore, expanding $k_{x,s} + k_{x,i}$ to first order in the frequency and angular shift, the δ -function in Eq. (5.33) allows to express one of the four variables as a function of the other three, e.g.

$$\omega_s(\theta_s, \theta_i, \omega_p) = \omega_s^0 + a(\theta_s - \theta_s^0) + b(\theta_i - \theta_i^0) + c(\omega_p - \omega_p^0), \quad (5.34)$$

see [171] for the explicit expression of the coefficient a , b and c ; in particular $a = -b$ if, as in our setting, $\omega_s^0 = \omega_i^0 = \omega_p^0/2$ and then $\theta_i^0 = -\theta_s^0$. For the sake of concreteness, let us consider

⁶This is due to the large waist of the laser of our experimental setup [172, 173].

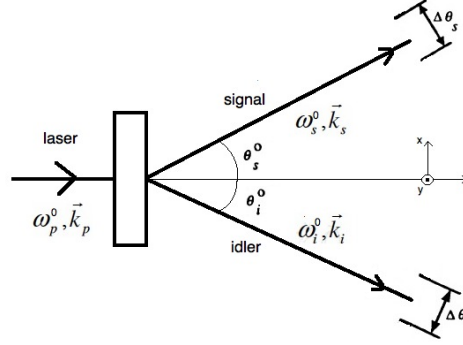

Figure 5.1: . Schematic representation of spontaneous parametric down conversion.

a uniaxial crystal with optical axis in the $x - z$ plane, so that the incident laser is supposed to have horizontal polarization, indicated as $|H\rangle$, while both the signal and the idler have vertical polarization $|V\rangle$. Thus, with the change of variables $\mathbf{k}_j \mapsto (\theta_j, \varphi_j, \omega_j)$, $j = s, i$, and assuming that the effective susceptibility is a slowly varying function compared to the laser amplitude and the sinc-function, the two-photon state generated by SPDC can be written as

$$|\psi\rangle = \int_0^\infty d\omega_p \int d\theta_s \int d\theta_i A(\omega_p) f(\theta_s, \theta_i, \omega_p) |V; \theta_s; \omega_s(\theta_s, \theta_i, \omega_p)\rangle |V; \theta_i; \omega_p - \omega_s(\theta_s, \theta_i, \omega_p)\rangle, \quad (5.35)$$

where we introduced a function f such that $f(\Delta k_{\parallel}) = C \text{sinc}(L\Delta k_{\parallel})$, with C normalization constant. As a consequence of energy and momentum conservation, the two-photon state in Eq. (5.35) cannot be written as a product state between a signal and an idler state. The two photons are entangled and, in particular, their frequency and angular degrees of freedom are entangled.

Nevertheless, in order to generate entanglement also with respect to the polarization degrees of freedom, we have to take into account a more complex setting [174, 175] than that described in Fig. (5.1). Namely, consider two uniaxial crystals with optical axes aligned in perpendicular planes, the first in the $x - z$ plane and the second in the $y - z$ plane. An incident laser with polarization $(|H\rangle + |V\rangle)/\sqrt{2}$ generates equally likely vertically polarized couples of photons in the first crystal as well as horizontally polarized couples in the second one⁷. The overall state is given by the sum of the amplitude probabilities of the two different paths, that is

$$|\psi\rangle = \frac{1}{\sqrt{2}} \int d\omega_p \int d\theta_s \int d\theta_i A(\omega_p) f(\theta_s, \theta_i, \omega_p) \left[|V; \theta_s; \omega_s(\theta_s, \theta_i, \omega_p)\rangle |V; \theta_i; \omega_p - \omega_s(\theta_s, \theta_i, \omega_p)\rangle + e^{i\phi(\theta_s, \theta_i, \omega_p)} |H; \theta_s; \omega_s(\theta_s, \theta_i, \omega_p)\rangle |H; \theta_i; \omega_p - \omega_s(\theta_s, \theta_i, \omega_p)\rangle \right]. \quad (5.36)$$

The phase term $\varphi(\omega_p, \theta_s, \theta_i)$ between vertical and horizontal polarization is due to the different optical paths followed by the couples of photons generated in the first and in the second crystal,

⁷The polarization of the photons generated in the second crystal can be considered horizontal, with respect to the coordinate system of the laboratory, since we deal with small generation angles.

respectively. Up to first order with respect to angular and frequency variables, the phase term reads

$$\phi(\theta_s, \theta_i, \omega_p) = \varphi_0 + \Delta\tau\omega_p + \gamma\theta_s - \gamma\theta_i + o(\theta_s, \theta_i, \omega_p), \quad (5.37)$$

see [172, 173] for the full phase term and for the expression of the coefficients in (5.37). The phase term $\Delta\tau\omega_p$ accounts for the temporal delay between the two downconversions. On the other hand, the last two terms are due to the fact that the photons generated in the first crystal have to traverse the second one [175].

5.2.2 Experimental setup

In our all-optical experimental setup the total system under investigation consists in a two-photon state produced by spontaneous parametric downconversion. We look at the evolution of the two-qubit polarization entangled state, which represents the reduced system, and trace out the momentum degrees of freedom, which are not observed and represent the environment. We exploit a programmable spatial light modulator (SLM) to impose an arbitrary polarization- and position-dependent phase-shift to the total state. This is a crystal liquid phase mask ($64 \times 10 \text{ mm}^2$) divided in 640 horizontal pixels, each wide $d = 100 \mu\text{m}$ and with the liquid crystal $10 \mu\text{m}$ deep. The photons with an horizontal polarization feels an extraordinary index of refraction depending on the orientation of the liquid crystal, and this introduces a phase-shift between the horizontal and the vertical polarizations. Since each pixel is driven independently, it is possible to introduce a phase function dependent on the position on the SLM, i.e., on the SPDC generation angles. A linear phase is set both on signal and idler beams in order to purify the state [176, 177], whereas an additional, generic, phase function may be imposed to introduce initial correlations between the polarization and the momentum degrees of freedom in a very general way. A further linear phase is then used to simulate the time evolution of the two-qubit state.

The experimental setup is shown in Fig. (5.2). A linearly polarized CW, 405 nm, diode laser

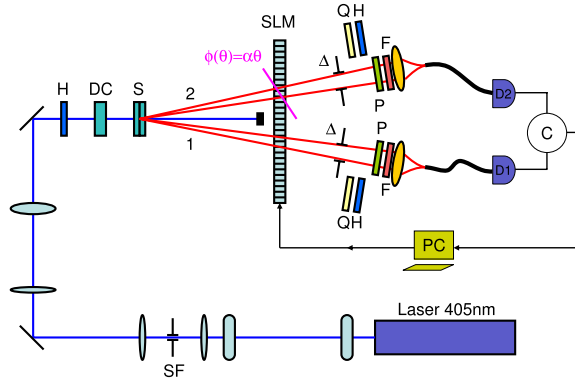

Figure 5.2: Diagram of the experimental setup.

(Newport LQC405-40P) passes through two cylindrical lenses which compensate beam astigmatism, then a spatial filter (SF) selects a Gaussian spatial profile and a telescopic system prepares a

collimated beam with beam radius of $550 \mu\text{m}$. A couple of 1mm Beta Barium Borate (S) crystals, cut for type-I down conversion, with optical axis aligned in perpendicular planes, are used as a source of couples of polarization and momentum entangled photons, as described in the previous paragraph. The half wave plate (H) set on the pump path rotates the pump polarization in order to balance the probability amplitudes of generating a $|VV\rangle$ couple of photons in the first crystal or an $|HH\rangle$ couple in the second one. The couples are generated around a central angle of $\pm 3^\circ$ and we select $\Delta = 10 \text{ mrad}$ with two slits set on signal (2) and idler (1) paths. Two long-pass filter (F) with cut-on wavelength of 780 nm set behind the couplers are used to reduce the background and to select about 60 nm around the central wavelength 810 nm , while the two polarizers (P) are used to perform visibility measurements as explained later on.

In order to achieve the highest possible purification of the polarization entangled state produced by SPDC, we compensate, at least at first order, the phase term due to the two crystal geometry, see Eqs. (5.36) and (5.37). The delay-time term $\Delta\tau\omega_p$ is precompensated by means of a nonlinear crystal (DC) with the proper length and angle, which is set on the pump path [178, 179, 172]. The constant term as well as the angular dependent terms in Eq. (5.37) are instead balanced by suitable phase terms inserted by means of the SLM both on the signal and on the idler, see Eq. (5.42) and the related discussion. Finally, the frequency distribution of the pump can be approximated by a δ -function, $A(\omega_p) = \delta(\omega_p - \Omega_p)$, i.e., we consider a monochromatic pump, and the angular amplitude $f(\theta_s, \theta_i, \omega_p)$ of the SPDC can be described by a factorized form $g(\theta_s)g(\theta_i)$, with $g(\theta)$ Gaussian-like shape function with full width at half maximum (FWHM) of 6 mrad , because of the large spectral distribution of our setting [180]. Summarizing, the two-photon state after the purification can be written as

$$|\psi\rangle = \frac{1}{\sqrt{2}} \int d\theta_s \int d\theta_i g(\theta_s)g(\theta_i) [|V\theta_s \omega_s\rangle|V\theta_i \omega_i\rangle + |H\theta_s \omega_s\rangle|H\theta_i \omega_i\rangle], \quad (5.38)$$

where the dependence of ω_s and $\omega_i = \Omega_p - \omega_s$ on θ_s and θ_i is implied.

5.2.3 Trace distance evolution

In our scheme the SLM, apart from the purification, performs two basic tasks. First, it allows us to engineer the correlated initial state by the introduction of an arbitrary phase $f(\theta_s)$. Aside from this, it provides the effective system-environment interaction term sensitive to both the polarization and the momentum degrees of freedom, through the introduction of a linear phase $\alpha\theta_s$, where α is the time evolution parameter. The total system-environment state for a generic value of the evolution parameter is thus given by:

$$|\psi_{SE}(\alpha)\rangle = \frac{1}{\sqrt{2}} \int d\theta_s d\theta_i g(\theta_s)g(\theta_i) \left(|H\theta_s \omega_s\rangle|H\theta_i \omega_i\rangle + e^{i(\alpha\theta_s + f(\theta_s))} |V\theta_s \omega_s\rangle|V\theta_i \omega_i\rangle \right). \quad (5.39)$$

Because of the phase $f(\theta_s)$, the state in Eq. (5.39) is correlated also at the initial time, i.e. for $\alpha = 0$:

$$\rho_{SE}(0) = |\psi_{SE}(0)\rangle\langle\psi_{SE}(0)| \neq \rho_S(0) \otimes \rho_E(0).$$

Upon tracing out the momentum degrees of freedom, the polarization state is given by

$$\rho_S(\alpha) = \frac{1}{2} (|HH\rangle\langle HH| + \epsilon(\alpha)|VV\rangle\langle HH| + \epsilon^*(\alpha)|HH\rangle\langle VV| + |VV\rangle\langle VV|), \quad (5.40)$$

where

$$\epsilon(\alpha) = \int d\theta_s |g(\theta_s)|^2 e^{i(\alpha\theta_s + f(\theta_s))}.$$

Since the angular distribution $g(\theta_s)$ is symmetric and we use odd functions $f(\theta_s)$, the quantity $\epsilon(\alpha)$ is real and it equals the interferometric visibility $V(\alpha) = \text{Re}[\epsilon(\alpha)]$.

In order to characterize the effect of the initial system-environment correlations via trace distance, we have to monitor the evolution of two different polarization states obtained from two different total initial states having the same environmental state. We compare an initially uncorrelated state $\rho_{SE}^1(\alpha)$, corresponding to Eq. (5.39) for $f(\theta_s) = 0$, with an initially correlated state $\rho_{SE}^2(\alpha)$ for a non-trivial function $f(\theta_s)$. In this way, the reduced system states $\rho_S^k(\alpha)$ $k = 1, 2$ are both of the form given by Eq. (5.40), with different $\epsilon_k(\alpha)$. Note that the product state $\rho_{SE}^1(0)$ differs from $\rho_S^2(0) \otimes \rho_E^2(0)$ only for an overall phase term in the integration over θ_s , which has no observable consequences on the dynamics of the polarization degrees of freedom⁸. The trace distance between the two reduced states under investigation is then given by

$$D(\rho_S^1(\alpha), \rho_S^2(\alpha)) = \frac{1}{2} |\epsilon_1(\alpha) - \epsilon_2(\alpha)| = \frac{1}{2} \left| \int d\theta_s |g(\theta_s)|^2 e^{i\alpha\theta_s} (1 - e^{if(\theta_s)}) \right|. \quad (5.41)$$

Different choices for the initial phase $f(\theta_s)$ result in different dynamical behavior of trace distance. We have exploited this fact to analyze in detail the effect of initial system-environment correlations on the subsequent evolution of the open system.

Experimental results

Experimentally, we have measured the quantity $\epsilon(\alpha)$ for $f(\theta_s) = 0$ and $f(\theta_s) = \sin(\lambda\theta_s)$, exploiting its equality with the visibility, obtained in the standard way by counting the coincidences with polarizers set at $45^\circ, 45^\circ$ and at $45^\circ, -45^\circ$ (see [172] for further details). The functions of the variable θ_s are discretized by the SLM, and thus become functions of the pixel number n . The resolution is given by h/D , where $h = 100 \mu\text{m}$ is the pixel width and $D = 330 \text{ mm}$ is the SLM distance from the source. In our experiment the SLM introduces the functions

$$\begin{aligned} \phi^1(n) &= -a_{opt}(n - n_1) + b \\ \phi^2(n, a) &= a_{opt}(n - n_2) + a(n - n_2) + f(n - n_2), \end{aligned} \quad (5.42)$$

⁸Explicitly, the total state evolved from $\tilde{\rho}_{SE}(0) = \rho_S^2(0) \otimes \rho_E^2(0)$, for a generic value of the evolution parameter α , is given by $\tilde{\rho}_{SE}(\alpha) = \frac{1}{2} (\rho_{SE}^1(\alpha) + |\varphi_{SE}(\alpha)\rangle\langle\varphi_{SE}(\alpha)|)$ with

$$|\varphi_{SE}(\alpha)\rangle = \frac{1}{\sqrt{2}} \int d\theta_s d\theta_i g(\theta_s) g(\theta_i) e^{if(\theta_s)} (|H\theta_s \omega_s\rangle|H\theta_i \omega_i\rangle + e^{i\alpha\theta_s} |V\theta_s \omega_s\rangle|V\theta_i \omega_i\rangle).$$

By taking the partial trace over the momentum degrees of freedom, one can immediately check that $\tilde{\rho}_S(\alpha) = \rho_S^1(\alpha)$.

on the two beams respectively, where $a_{opt} = 0.1$ rad/pixel is an optimal slope used to achieve the maximal purification of the polarization entangled state, that is to compensate the angular dependent terms in Eq. (5.37), and the constant b is used to offset the residual constant term. The integers n_1 and n_2 are the central pixel numbers on the idler and on the signal beams. The experimental evolution parameter is then $a = \alpha h/D$ and it is expressed in rad/pixel.

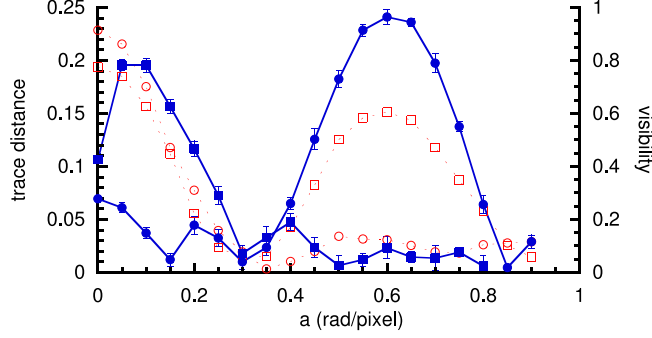

Figure 5.3: Trace distance and visibility as a function of the experimental evolution parameter a , the two quantities are related through Eq. (5.41). Full circles describe the trace distance between $\rho_S^1(a)$, i.e. $f(n-n_2) = 0$, and $\rho_S^2(a)$ with $f(n-n_2) = \sin(\lambda(n-n_2))$, $\lambda = -0.6$ rad/pixel. Full squares describe the trace distance between $\rho_S^1(a)$ and $\rho_S^2(a)$ with $f(n-n_2) = \tau(n-n_2)$, $\tau = 0.1$ rad/pixel. Lines are a guide for the eye. Empty circles refer to visibility with the choice $f(n-n_2) = 0$, whereas empty squares refer to the case in which initial correlations are introduced through the phase function $f(n-n_2) = \sin[\lambda(n-n_2)]$. For the visibility uncertainties are within the symbols.

Trace distance is the quantity which reveals the presence and the effects of initial correlations, and its behavior is reported in Fig. (5.3), together with visibility that provides the raw data from which trace distance can be extracted in the present case. In the figure, full circles describe the trace distance, as a function of the evolution parameter a , between the reduced state $\rho_S^1(a)$ evolved from the total initial product state, i.e. $f(n-n_2) = 0$, and the reduced state $\rho_S^2(a)$ related to the initial correlated state with $f(n-n_2) = \sin(\lambda(n-n_2))$. The trace distance, after an initial decrease and a first small oscillation, presents a revival up to a value which is more than three times the initial one. As expected, the reduced system can access information which is initially outside it, related to its initial correlations with the environment. The trace distance reaches its maximum around $a = 0.6$ rad/pixel, toward the end of the monitored time interval. The maximum of trace distance quantifies the total amount of information which can be accessed by means of measurements performed on the reduced system only [30]. Note that it can be shifted to smaller values of the evolution parameter a by decreasing the absolute value of λ . Thus, by introducing a sinusoidal phase modulation via the SLM, we have obtained a behavior of trace distance that highlights the presence of initial correlations and their effects in the subsequent evolution, also for long times [181].

The simplest choice for the phase $f(n-n_2)$ in the initially correlated state $\rho_{SE}^2(\alpha)$ is a second linear phase aside from that containing the evolution parameter a , i.e. $f(n-n_2) = \tau(n-n_2)$.

Indeed, this corresponds to shift the initially uncorrelated state $\rho_{SE}^1(\alpha)$ forward in time by τ . Then, from the visibility measurement, we can directly obtain the evolution of the trace distance between $\rho_S^1(a)$ and $\rho_S^2(a)$ with $f(n - n_2) = \tau(n - n_2)$. This is represented by full squares in Fig. (5.3), for $\tau = 0.1$ rad/pixel. In this case the growth of the distinguishability between the two reduced states starts from the very beginning of the dynamics. As expected, the trace distance increases over its initial value, reaching its maximum value at $a = 0.1$ rad/pixel and decreasing afterwards. The subsequent oscillations can be traced back to the finite pixel size. Notice also that by using a linear term, we cannot obtain a revival of trace distance over its initial value for high values of a , contrary to the previous case. Since now $\rho_S^2(a) = \rho_S^1(a + \tau)$, the full squares in Fig. (5.3) also describe the evolution of the trace distance between a pair of reduced states occurring at two different points, separated by τ , of the same dynamics starting from the product total initial state given by $\rho_{SE}^1(0)$. From this point of view, the increase over the initial value of trace distance indicates that the single evolution under investigation is not compatible with a description through a dynamical semigroup Λ_t , which could be introduced, e.g., on the basis of some phenomenological ansatz. Indeed, the semigroup property $\Lambda_{t+\tau} = \Lambda_t \Lambda_\tau$, together with the trace distance contractivity under CPT maps, would imply $D(\rho_S^1(t), \rho_S^2(t)) = D(\Lambda_t \rho_S^1(0), \Lambda_t \rho_S^1(\tau)) \leq D(\rho_S^1(0), \rho_S^1(\tau)) = D(\rho_S^1(0), \rho_S^2(0))$. However, in general one cannot discriminate in this way whether the deviations from the semigroup dynamics are due to correlations in the initial total state or to other sources of non-Markovianity [182].

State reconstruction

In order to reconstruct the trace distance evolution, we only had to perform visibility measurements to access the off-diagonal values $\epsilon_i(\alpha)$. From a mathematical point of view, this corresponds to explicitly determine the projection operator defining the trace distance via the relation $D(\rho^1, \rho^2) = \max_{\Pi} \text{Tr} \{ \Pi (\rho^1 - \rho^2) \}$, where the maximum is taken over all the projectors Π or, equivalently, over all the positive operators $\Pi \leq \mathbb{1}$, see Eq. (C.9). Upon considering the subspace spanned by $\{|HH\rangle, |VV\rangle\}$ and the corresponding σ_x Pauli matrix, the maximum is here obtained from the projectors on the eigenvectors of σ_x , which indeed give back half the difference between the visibilities. However, in more general situations one could need a full tomographic reconstruction of the reduced states. This would be the case in the presence of non-real coefficients $\epsilon_k(\alpha)$ or when dealing with partially or fully unknown states. For this reason, we have also performed state reconstruction by polarization qubit tomography. By means of a quarter-wave plate, a half-wave plate and a polarizer, we have measured a suitable set of independent two-qubit projectors [183, 184] and then used the maximum-likelihood reconstruction of the two-qubit polarization density matrix. In Fig. (5.4) (left) we show the tomographic reconstruction of the polarization state just after the purification and without any initial correlation, i.e. for $f(n - n_2) = 0$ and $a = 0$. The visibility is 0.914 ± 0.006 (not exactly one mostly because of the large spectrum detected). In Fig. (5.4) (right) we report the two-qubit tomography for the state characterizing the maximum revival of the visibility in the presence of initial correlations given by $f(n - n_2) = \sin[\lambda(n - n_2)]$, i.e. at $a = 0.6$ rad/pixel. The corresponding visibility is 0.605 ± 0.007 . Finally, let us emphasize that the spatial light modulator allows us to introduce initial correlations

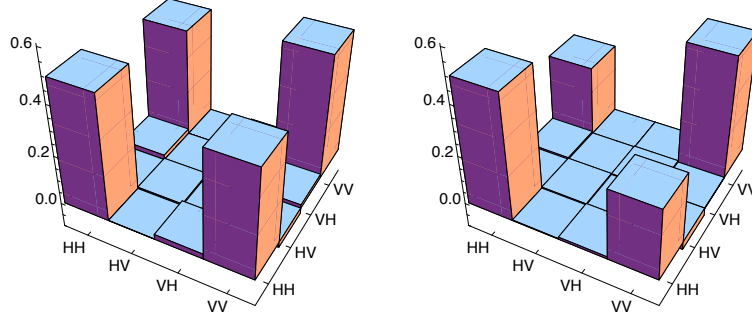

Figure 5.4: Tomographic reconstruction of the two-qubit density matrix just after the purification (left), without any initial phase, i.e. for $f(n - n_2) = 0$ and $a = 0$. The visibility is 0.914 ± 0.006 . Tomographic reconstruction for $f(n - n_2) = \sin(\lambda(n - n_2))$ at $a = 0.6$ (right), i.e. at the maximum of the visibility revival [compare with Fig. (5.3)]. The corresponding visibility is 0.605 ± 0.007 .

in a very general way. In particular, by means of this setup we can engineer different kinds of dynamical behavior of the trace distance, so that, e.g., the position and the amplitude of the revival points of the distinguishability can be tuned.

5.3 Initial correlations in the Jaynes-Cummings model

In this section, we show how the analysis performed by means of the trace distance, apart from the basic detection of initial system-environment correlations, supplies more general connections between structural features of the total initial state and relevant aspects of the subsequent dynamics. In particular, we take into account the Jaynes-Cummings model, already considered in Sec. (3.2), since the knowledge of the exact joint dynamics of system and reservoir, see Eq. (3.52), allows the treatment of initial states with arbitrary correlations. The material of this section is for the most part contained in [30].

5.3.1 Exact reduced evolution for generic initial state

With the help of the unitary time-evolution operator given by Eq. (3.52) we can easily determine the exact expression for the reduced density matrix of the two-level system at time t ,

$$\rho_S(t) = \begin{pmatrix} \rho_{11}(t) & \rho_{10}(t) \\ \rho_{10}^*(t) & \rho_{00}(t) \end{pmatrix}, \quad (5.43)$$

corresponding to an arbitrary initial state $\rho_{SE}(0)$ of the total system. First, we expand $\rho_{SE}(0)$ with respect to the basis vectors $|\alpha\rangle \otimes |n\rangle \equiv |\alpha, n\rangle$, where $\alpha = 1, 0$ labels the states of the two-state

system, and $n = 0, 1, 2, \dots$ the number states of the field mode,

$$\rho_{SE}(0) = \sum_{\alpha, \beta, m, n} \rho_{\alpha\beta}^{mn}(0) |\alpha, m\rangle \langle \beta, n|. \quad (5.44)$$

Substituting this expression into Eq. (2.94) with $U(t)$ given by Eq. (3.52), one obtains

$$\begin{aligned} \rho_{11}(t) &= \sum_n \left[\rho_{11}^{nn}(0) |c_{n+1}(t)|^2 + 2\sqrt{n+1} \operatorname{Re} \left\{ \rho_{10}^{n, n+1}(0) d_{n+1}^*(t) c_{n+1}(t) \right\} + n \rho_{00}^{nn}(0) |d_n(t)|^2 \right] \\ \rho_{10}(t) &= \sum_n \left[-\sqrt{n+1} \rho_{11}^{n+1, n}(0) c_{n+2}(t) d_{n+1}(t) - \sqrt{n+2} \sqrt{n+1} \rho_{01}^{n+2, n}(0) d_{n+2}(t) d_{n+1}(t) \right. \\ &\quad \left. + \rho_{10}^{nn}(0) c_{n+1}(t) c_n(t) + \sqrt{n+1} \rho_{00}^{n+1, n}(0) d_{n+1}(t) c_n(t) \right], \end{aligned} \quad (5.45)$$

where $c_n(t)$ and $d_n(t)$ denote the eigenvalues of $c(\hat{n}, t)$ and $d(\hat{n}, t)$ corresponding to the eigenstate $|n\rangle$, respectively, see Eqs. (3.53) and (3.54).

We note that Eq. (5.45) does not lead directly to a dynamical map for the evolution of the reduced two-state system since it is not possible to write the right-hand side of this equation as a function of the matrix elements of the reduced initial state $\rho_S(0)$ which are given by

$$\rho_{\alpha\beta}(0) = \sum_n \rho_{\alpha\beta}^{nn}(0). \quad (5.46)$$

However, if the total initial state is of tensor product form, $\rho_{SE}(0) = \rho_S(0) \otimes \rho_E(0)$ and, therefore,

$$\rho_{\alpha\beta}^{nm}(0) = \rho_{\alpha\beta}(0) \rho^{nm}(0), \quad (5.47)$$

it is indeed possible to construct the dynamical map; if moreover $[\rho_E(0), \hat{n}] = 0$, one finds the map already derived in Sec. (3.2).

5.3.2 Dynamics of the trace distance for pure or product total initial states

We illustrate the dynamics of the trace distance and the inequality (5.24) by means of two simple examples, considering the situation in which the total initial state is a product state or a pure state. The case of a mixed, correlated initial state will be considered in detail in the next paragraph.

The quantity on the right-hand side of Eq. (5.24), representing the information which is initially outside the reduced system, can be larger than zero basically for two reasons: first, because one has different environmental initial states $\rho_E^1(0)$ and $\rho_E^2(0)$ and, second, because of the presence of correlations in the initial states $\rho_{SE}^1(0)$ or $\rho_{SE}^2(0)$ (see inequality (5.25)). To illustrate the first case we study the trace distance between the two reduced states $\rho_S^1(t)$ and $\rho_S^2(t)$ evolving from two product initial states with the same reduced system state, namely from $\rho_{SE}^1(0) = \rho_S(0) \otimes \rho_E^1(0)$ and $\rho_{SE}^2(0) = \rho_S(0) \otimes \rho_E^2(0)$, where

$$\rho_S(0) = |\alpha_1|^2 |0\rangle \langle 0| + |\beta_1|^2 |1\rangle \langle 1| \quad (5.48)$$

and the two environmental states are taken to be

$$\rho_E^i(0) = |\alpha_i|^2 |n\rangle \langle n| + |\beta_i|^2 |n-1\rangle \langle n-1|, \quad i = 1, 2, \quad (5.49)$$

with the normalization condition $|\alpha_i|^2 + |\beta_i|^2 = 1$. Numerical simulation results for this case are shown in Fig. (5.5.a). We see from the figure that the bound of Eq. (5.24), which is given by $||\alpha_1|^2 - |\alpha_2|^2|$, is indeed reached here. For a study of the second case we consider an initially correlated pure state of the form

$$\rho_{SE}^1(0) = |\psi\rangle\langle\psi|, \quad (5.50)$$

with $|\psi\rangle = \alpha|0, n\rangle + \beta|1, n-1\rangle$, $|\alpha|^2 + |\beta|^2 = 1$, together with a product initial state of the form

$$\rho_{SE}^2(0) = \rho_S^2(0) \otimes \rho_E^2(0) \quad (5.51)$$

with $\rho_S^2(0) = |\beta|^2|0\rangle\langle 0| + |\alpha|^2|1\rangle\langle 1|$ and $\rho_E^2(0) = |\alpha|^2|n\rangle\langle n| + |\beta|^2|n-1\rangle\langle n-1|$. Note that $\rho_{SE}^2(0)$ is not equal to the product of the marginals of $\rho_{SE}^1(0)$. As can be seen from Fig. (5.5.b) also for this case the bound of Eq. (5.24), which is given by $\frac{1}{2}(1 + |\alpha|^4 + |\beta|^4)$, is repeatedly reached in the course of time. As expected, in both cases the trace distance of the states exceeds its initial value, corresponding to the fact that the reduced system dynamically retrieves the information initially not accessible to it, related to the different initial environmental states or to the initial system-environment correlations. Note that the trace distance starts increasing already at the initial time, indicating that the information is flowing to the reduced system from the very beginning of the dynamics. Moreover, it keeps oscillating also for large values of t , so that the distinguishability growth between reduced states can be detected, e.g. by quantum state tomography, also making observations after a long interaction time [181].

In both situations considered and visualized in Fig. (5.5) the maximum value of the trace distance

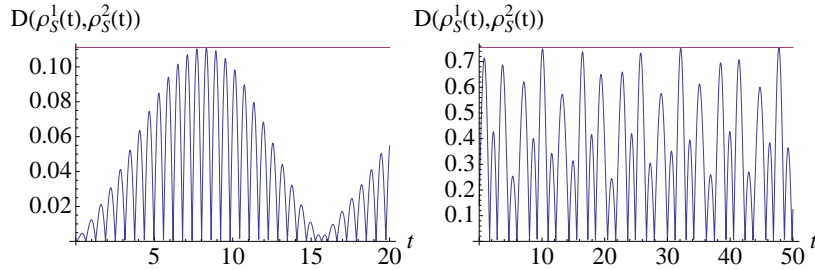

Figure 5.5: (a, b) Plot of the trace distance $D(\rho_S^1(t), \rho_S^2(t))$ as a function of time, in arbitrary units, where $\rho_S^1(t)$ and $\rho_S^2(t)$ have been determined from Eq. (5.45). In both figures the horizontal line marks the upper bound of Eq. (5.24), and $\Delta = 0.1, g = 1$ in a.u.. (a) Dynamics for two product total initial states which differ only by the environmental states and are given by Eq. (5.48) and (5.49) with $|\alpha_1|^2 = 7/9$, $|\alpha_2|^2 = 8/9$ and $n = 7$. (b) The two reduced states $\rho_S^1(t)$ and $\rho_S^2(t)$ are obtained from the total initial states given by Eqs. (5.50) and (5.51) which have the same environmental marginal state, but different reduced system states and correlations. Parameters: $\alpha = i\sqrt{3/7}$, $\beta = \sqrt{4/7}$ and $n = 1$.

as a function of time is equal to the upper bound given by Eq. (5.24), indicating that the information initially inaccessible to the reduced system has been transferred completely to it during the subsequent dynamics. This is of course not always the case and it is an important problem to characterize explicitly those initial states for which such a behavior indeed occurs. Let us consider the

special case given by Eq. (5.26), in which the two total initial states are a correlated state and the tensor product of its marginals, taking $\rho_{SE}^1(0)$ to be a pure entangled state, i.e., $\rho_{SE}^1(0) = |\psi\rangle\langle\psi|$ with $|\psi\rangle = \alpha|0, n\rangle + \beta|1, m\rangle$. For this case Eq. (5.45) leads to

$$D(\rho_S^1(t), \rho_S^2(t)) = \left| |\alpha\beta|^2 (|c_{m+1}(t)|^2 - |c_n(t)|^2 + |c_m(t)|^2 - |c_{n+1}(t)|^2) + 2\delta_{m,n-1}\sqrt{n} \operatorname{Re} \{ \alpha^* \beta a_n^*(t) c_n(t) \} \right|, \quad (5.52)$$

while the right-hand side of Eq. (5.26) becomes

$$D(\rho_{SE}^1(0), \rho_S^1(0) \otimes \rho_E^1(0)) = |\alpha\beta|^2 + |\alpha\beta|. \quad (5.53)$$

Taking into account Eqs. (3.53)-(3.55), for $n, m \gg \Delta^2/4g^2$ Eq. (5.52) explicitly reads

$$D(\rho_S^1(t), \rho_S^2(t)) = \left| |\alpha\beta|^2 \left[\cos^2(g\sqrt{m+1}t) - \cos^2(g\sqrt{n}t) + \cos^2(g\sqrt{m}t) - \cos^2(g\sqrt{n+1}t) \right] - \delta_{m,n-1} \operatorname{Im} \{ \alpha^* \beta \} \sin(2g\sqrt{n}t) \right|, \quad (5.54)$$

which is an almost periodic function [185] since it represents a linear combination of sine and cosine functions with incommensurable periods. The supremum of the attained values⁹ is less than or equal to $2|\alpha\beta|^2$ if $m \neq n$ and $m \neq n-1$, and equal to $|\alpha\beta|^2 + |\operatorname{Im} \{ \alpha^* \beta \}|$ if $m = n-1$. Thus, the inequality in Eq. (5.26) is tight only for those initial states for which $m = n-1$ and $\operatorname{Re} \{ \alpha^* \beta \} = 0$ (indeed, we have $|\alpha\beta|^2 + |\alpha\beta| = 2|\alpha\beta|^2$ if and only if either $\alpha = 0$ or $\beta = 0$). The special role of the initial states with $m = n-1$ can be traced back to the structure of the full unitary evolution given by Eq. (3.52) and to the presence of the creation and annihilation operators in the off-diagonal matrix elements. Their action generates, in fact, the last term in the modulus on the right-hand side of Eq. (5.54), which for $m = n-1$ is necessary to reach the bound. If the relation $n, m \gg \Delta^2/4g^2$ is not satisfied, the supremum lies in general strictly below the bound even if the above mentioned conditions are fulfilled. This is a consequence of the fact that the periodic functions $|c_n(t)|^2$ are then strictly less than 1.

Moreover, note that in general the classical or quantum nature of initial correlations does not influence whether the upper bound is actually reached in the course of the dynamics [26].

5.3.3 Gibbs initial state: total amount of correlations

We now extend our considerations to the evolution of the trace distance between a mixed correlated initial state and the tensor product of its marginals. Specifically, we will analyze the inequality given in Eq. (5.26) when the correlated initial state ρ_{SE} is the invariant Gibbs (thermal equilibrium) state corresponding to the full Hamiltonian H of the model. For simplicity we will omit in the following the time argument zero. We first analyze the total amount of correlations in the initial state $D(\rho_{SE}, \rho_S \otimes \rho_E)$, i.e., the upper bound for the trace distance according to Eq. (5.26). As we shall show below, the main features of this bound can be explained in terms of the correlations in the ground state of the Hamiltonian H . Indeed, the study of the amount of correlations

⁹Due to the incommensurability of the frequencies, there is no time t at which $D(\rho_S^1(t), \rho_S^2(t))$ attains the supremum.

possessed by the thermal state can be of interest on its own, see e.g. [186] and references therein. However, we are here interested in the relation of this quantity with the actual dynamics of the trace distance, which will turn out to reflect the characteristic features of the correlations in the Gibbs state.

Consider the total initial Gibbs state

$$\rho_{SE} = \frac{1}{Z} e^{-\beta H}, \quad (5.55)$$

where H is the total Hamiltonian of the system given by Eqs. (3.47)-(3.50), $Z = \text{Tr} e^{-\beta H}$ denotes the partition function and $\beta = 1/k_b T$ with k_b the Boltzmann constant and T the temperature. To calculate the marginal states $\rho_S = \text{tr}_E e^{-\beta H}/Z$ and $\rho_E = \text{tr}_S e^{-\beta H}/Z$ it is useful to obtain the matrix elements of ρ_{SE} with respect to the basis $\{|\alpha, n\rangle\}$. This can be done by using the dressed states [187], i.e., the eigenvectors of the Hamiltonian H . These eigenvectors can be written as

$$\begin{aligned} |\Phi_n^+\rangle &= a_n |1, n-1\rangle + b_n |0, n\rangle, \\ |\Phi_n^-\rangle &= -b_n |1, n-1\rangle + a_n |0, n\rangle, \\ |\Phi_0^-\rangle &= |0, 0\rangle, \end{aligned} \quad (5.56)$$

with $n = 1, 2, 3, \dots$ and

$$a_n = \sqrt{\frac{\Omega_n + \Delta}{2\Omega_n}}, \quad b_n = \sqrt{\frac{\Omega_n - \Delta}{2\Omega_n}}, \quad (5.57)$$

where $\Omega_n = \sqrt{\Delta^2 + 4g^2 n}$ (see Eq. (3.55)). The corresponding eigenvalues are given by

$$E_n^\pm = n\omega + \frac{\Delta}{2} \pm \frac{\Omega_n}{2}, \quad E_0^- = 0. \quad (5.58)$$

Inverting Eqs. (5.56) with the help of the relations

$$\begin{aligned} |0, n\rangle &= b_n |\Phi_n^+\rangle + a_n |\Phi_n^-\rangle, \\ |1, n\rangle &= a_{n+1} |\Phi_{n+1}^+\rangle - b_{n+1} |\Phi_{n+1}^-\rangle, \end{aligned} \quad (5.59)$$

one obtains the expressions

$$\begin{aligned} \rho_{00}^{nm} &= \frac{1}{Z} \delta_{n,m} \left(e^{-\beta E_n^+} b_n^2 + e^{-\beta E_n^-} a_n^2 \right), \\ \rho_{11}^{nm} &= \frac{1}{Z} \delta_{n,m} \left(e^{-\beta E_{n+1}^+} a_{n+1}^2 + e^{-\beta E_{n+1}^-} b_{n+1}^2 \right), \\ \rho_{10}^{nm} = \rho_{01}^{mn} &= \frac{1}{Z} \delta_{n+1,m} \left(e^{-\beta E_{n+1}^+} - e^{-\beta E_{n+1}^-} \right) a_{n+1} b_{n+1}, \end{aligned} \quad (5.60)$$

which represent the matrix elements of the Gibbs state,

$$\rho_{SE} = \sum_{\alpha, \beta, n, m} \rho_{\alpha\beta}^{nm} |\alpha, n\rangle \langle \beta, m|. \quad (5.61)$$

Using this result together with Eq. (5.46) we see that the reduced system state is diagonal in the basis $|\alpha\rangle$ and that the diagonal elements are given by $\rho_{11} = 1 - \rho_{00}$ and

$$\rho_{00} = \frac{1}{Z} \sum_{n=0}^{\infty} \left(e^{-\beta E_n^+} b_n^2 + e^{-\beta E_n^-} a_n^2 \right). \quad (5.62)$$

The reduced state of the environment is also diagonal since $\rho^{nm} = 0$ for $n \neq m$, and the diagonal elements can be expressed as

$$\rho^{nn} = \frac{1}{Z} \left(e^{-\beta E_n^+} b_n^2 + e^{-\beta E_n^-} a_n^2 + e^{-\beta E_{n+1}^+} a_{n+1}^2 + e^{-\beta E_{n+1}^-} b_{n+1}^2 \right). \quad (5.63)$$

The product state constructed from the marginals is accordingly of the form

$$\rho_S \otimes \rho_E = \sum_{\alpha, n} \rho_{\alpha\alpha} \rho^{nn} |\alpha, n\rangle \langle \alpha, n|. \quad (5.64)$$

Finally, the normalization constant Z can be written as

$$Z = \sum_n \left(e^{-\beta E_n^+} b_n^2 + e^{-\beta E_n^-} a_n^2 + e^{-\beta E_{n+1}^+} a_{n+1}^2 + e^{-\beta E_{n+1}^-} b_{n+1}^2 \right). \quad (5.65)$$

Starting from the above relations we can analytically calculate the total amount of correlations of the Gibbs state, i.e., the quantity $D(\rho_{SE}, \rho_S \otimes \rho_E)$. To this end, we order the elements of the basis as $\{|0, 0\rangle, |1, 0\rangle, |0, 1\rangle, |1, 1\rangle, |0, 2\rangle, |1, 2\rangle, \dots\}$. The difference $X = \rho_{SE} - \rho_S \otimes \rho_E$ between the Gibbs state and its corresponding product state can then be written in block diagonal form,

$$X = \begin{pmatrix} D_0^0 & 0 & 0 & 0 & 0 & 0 & \dots & \dots \\ 0 & D_1^0 & \rho_{10}^{01} & 0 & 0 & 0 & \dots & \dots \\ 0 & \rho_{01}^{10} & D_0^1 & 0 & 0 & 0 & \dots & \dots \\ 0 & 0 & 0 & D_1^1 & \rho_{10}^{12} & 0 & \dots & \dots \\ 0 & 0 & 0 & \rho_{01}^{21} & D_0^2 & 0 & \dots & \dots \\ 0 & 0 & 0 & 0 & 0 & \ddots & 0 & 0 \\ \vdots & \vdots & \vdots & \vdots & \vdots & D_1^n & \rho_{10}^{n, n+1} & 0 \\ \vdots & \vdots & \vdots & \vdots & \vdots & \rho_{01}^{n+1, n} & D_0^{n+1} & 0 \\ \vdots & \vdots & \vdots & \vdots & \vdots & 0 & 0 & \ddots \end{pmatrix}, \quad (5.66)$$

where

$$D_\alpha^n = \rho_{\alpha, \alpha}^{n, n} - \rho_{\alpha, \alpha} \rho^{n, n}. \quad (5.67)$$

It is easy to demonstrate that $D_1^n = -D_0^n$, implying that the matrix of Eq. (5.66) has zero trace, as it should have. The eigenvalues of this matrix are simply given by the eigenvalues of the 2×2

block matrices plus the top left element D_0^0 . Hence, the total amount of correlations in the Gibbs state is given by

$$D(\rho_{SE}, \rho_S \otimes \rho_E) = \frac{1}{2}|D_0^0| + \frac{1}{4} \sum_{n=0}^{\infty} \left| D_1^n + D_0^{n+1} + \sqrt{(D_1^n - D_0^{n+1})^2 + 4(\rho_{1,0}^{n,n+1})^2} \right| \\ + \frac{1}{4} \sum_{n=0}^{\infty} \left| D_1^n + D_0^{n+1} - \sqrt{(D_1^n - D_0^{n+1})^2 + 4(\rho_{1,0}^{n,n+1})^2} \right|. \quad (5.68)$$

This quantity depends on the model parameters ω , Δ and g which characterize the Hamiltonian described by Eqs. (3.47)-(3.50), as well as on the temperature. In the following we will focus in particular on the dependence of $D(\rho_{SE}, \rho_S \otimes \rho_E)$ on the coupling constant g and on the inverse temperature β for fixed values of the other two parameters (indeed from the expression of the Gibbs state it immediately appears that the dependence on one of the parameters can be reabsorbed into the others).

Dependence on the ground state

The behavior of the trace distance given by Eq. (5.68) as a function of β and g is plotted in Fig. (5.6). We clearly see a non-monotonic behavior of the trace distance as a function of both parameters. Focusing on the dependence on β for a fixed value of g , we observe that there is a sudden transition between two different kinds of behavior: below a critical value of the coupling constant g , the trace distance as a function of β exhibits an initial peak and then goes down to zero, see also Fig. (5.6.b); above this critical g it keeps growing to an asymptotic value different from zero, which we will discuss later on, as can be seen from Fig. (5.6.c). On the other hand, the dependence of the trace distance on g for a fixed value of β shows some oscillations after a sudden growth which occurs at the critical g , see Figs. (5.6.a) and (5.6.e). Quite remarkably, this means that the total amount of correlations of the Gibbs state can decrease with increasing coupling constant, as clearly observed in Fig. (5.6.d).

The above features can be explained by considering that the trace distance $D(\rho_{SE}, \rho_S \otimes \rho_E)$ quantifies the correlations of the Gibbs state ρ_{SE} and that the limit $\beta \rightarrow \infty$ corresponds to the limit of zero temperature, where the Gibbs state reduces to the ground state of the Hamiltonian H . If all the eigenvalues given by Eq. (5.58) are non-negative the ground state is $|\Phi_0^-\rangle = |0, 0\rangle$ with eigenvalue zero. Of course, this is a product state and, therefore, the correlations of the Gibbs state approach zero for $\beta \rightarrow \infty$. This is what happens below the critical g . However, according to the level crossing described in Fig. (5.7), the Hamiltonian has negative eigenvalues for larger values of the coupling constant g . In fact, it is easy to see from Eq. (5.58) that if

$$g > \bar{g}_1 \equiv \sqrt{\omega^2 + \omega\Delta} \quad (5.69)$$

then $E_1^- < 0$ and, therefore, $|0, 0\rangle$ is no longer the ground state. Thus, we can then identify \bar{g}_1 as the previously mentioned critical value of g , since for larger values the lowest energy state is $|\Phi_1^-\rangle$ which is an entangled state according to Eq. (5.56) with correlations $a_1^2 b_1^2 + a_1 b_1$ different from zero. But looking at the dependence of the different eigenvalues E_n^- on the coupling constant g , see

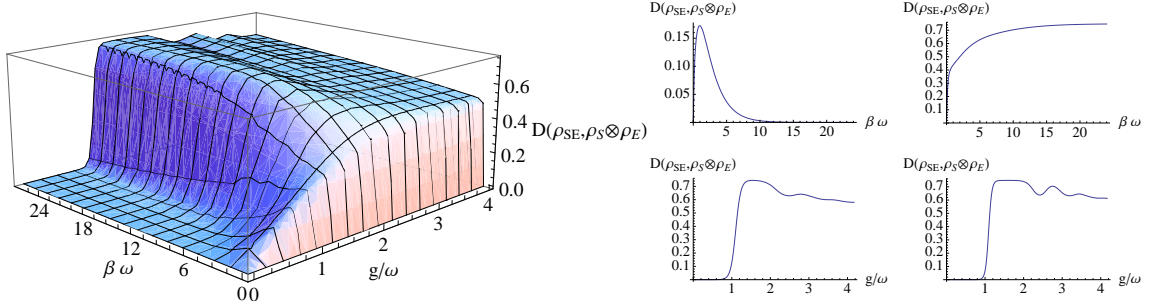

Figure 5.6: (a) Plot of the correlations of the Gibbs state (5.55) as a function of the inverse temperature β and of the coupling constant g according to Eq. (5.68) for $\Delta/\omega = 1/6$. (b, c, d, e From top left to bottom right) Sections of the plot at the left, corresponding to $g/\omega = 0.57$, $g/\omega = 1.83$, $\beta\omega = 15$ and $\beta\omega = 24$, respectively. The critical value of g is given by $\bar{g}_1/\omega = 1.08$, see Eq. (5.69).

Fig. (5.7), we can see that there is another critical point, let us call it \bar{g}_2 , where $E_2^-(\bar{g}_2) = E_1^-(\bar{g}_2)$ and after which $E_2^-(g) < E_1^-(g)$, i.e., $|\Phi_2^- \rangle$ becomes the lowest energy state. We then have another value \bar{g}_3 for which $E_3^-(\bar{g}_3) = E_2^-(\bar{g}_3)$, so that for stronger couplings $|\Phi_3^- \rangle$ becomes the new ground state, and so on. Between two successive critical values \bar{g}_k and \bar{g}_{k+1} the ground state of the Hamiltonian is $|\Phi_k^- \rangle$, whose correlations according to Eq. (5.53) are given by

$$D(\rho_{SE}, \rho_S \otimes \rho_E) = a_k^2 b_k^2 + a_k b_k = \frac{g^2 k}{\Delta^2 + 4g^2 k} + \sqrt{\frac{g^2 k}{\Delta^2 + 4g^2 k}}. \quad (5.70)$$

This expression characterizes the asymptotic value of the correlations in the Gibbs state for $\beta \rightarrow \infty$ and for g between \bar{g}_k and \bar{g}_{k+1} . We note that $D(\rho_{SE}, \rho_S \otimes \rho_E)$ approaches the value $\frac{3}{4}$ if we also let $g \rightarrow \infty$. As is shown in Appendix D, this asymptotic value corresponds in fact to the maximal possible value of the correlations for the present model.

We see from Fig. (5.7) that for small temperatures the correlations in the Gibbs state exhibit a dip at every \bar{g}_k with $k > 1$. Again, this feature can be explained by considering the ground level of the Hamiltonian given by Eqs. (3.47)-(3.50). For $g = \bar{g}_k$ the eigenspace of the lowest energy level is two-fold degenerate since $E_k^-(\bar{g}_k) = E_{k-1}^-(\bar{g}_k)$ and the Gibbs state reduces to

$$\frac{1}{2} (|\Phi_{k-1}^- \rangle \langle \Phi_{k-1}^-| + |\Phi_k^- \rangle \langle \Phi_k^-|) \quad (5.71)$$

where, again we have ordered the elements of the basis as $\{|1, k-2\rangle, |0, k-1\rangle, |1, k-1\rangle, |0, k\rangle\}$. Equation (5.71) can be directly obtained from Eq. (5.60), observing that for $\beta \rightarrow \infty$ the only non-negligible terms are those involving the exponentials of βE_{k-1}^- or βE_k^- . Calculating now the corresponding product state and proceeding as done to obtain Eq. (5.68), or directly taking the limit of this equation for $\beta \rightarrow \infty$ and $g = \bar{g}_k$, one finds an explicit expression for the correlations

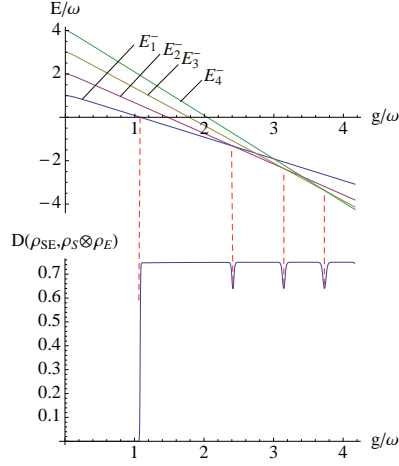

Figure 5.7: (Top) Plot of the first energy eigenvalues E_1^- , E_2^- , E_3^- , E_4^- given by Eq. (5.58) as functions of g , E_0^- coincides with the x -axis. (Bottom) Plot of the correlations of the Gibbs state as a function of g for $\beta\omega = 300$, i.e., for approximately zero temperature; the other values are the same as in Fig. (5.6.a). The critical values of the correlations as a function of g exactly correspond to the level crossing points: when $E_0^- = E_1^-$ there is a sudden increase and at the subsequent points the dips occur. For this value of β the behavior described by the exact expression is well approximated by Eq. (5.70) between the dips and by Eq. (5.72) at the dips.

of the mixed state given by Eq. (5.71):

$$\begin{aligned}
 D(\rho_{SE}, \rho_S \otimes \rho_E) &= \frac{1}{2} \left[\alpha + \frac{1}{2} |\gamma_1 + \delta_1 + \sqrt{(\gamma_1 - \delta_1)^2 + 4\varepsilon_1^2}| \right. \\
 &\quad + \frac{1}{2} |\gamma_1 + \delta_1 - \sqrt{(\gamma_1 - \delta_1)^2 + 4\varepsilon_1^2}| \\
 &\quad + \frac{1}{2} |\gamma_2 + \delta_2 + \sqrt{(\gamma_2 - \delta_2)^2 + 4\varepsilon_2^2}| \\
 &\quad \left. + \frac{1}{2} |\gamma_2 + \delta_2 - \sqrt{(\gamma_2 - \delta_2)^2 + 4\varepsilon_2^2}| + \chi \right], \quad (5.72)
 \end{aligned}$$

where

$$\begin{aligned}
 \alpha &= \frac{b_{k-1}^2}{4} (a_{k-1}^2 + a_k^2); \quad \gamma_1 = \frac{b_{k-1}^2}{2} - \frac{b_{k-1}^2}{4} (b_{k-1}^2 + b_k^2); \quad \varepsilon_1 = -\frac{a_{k-1}b_{k-1}}{2}; \\
 \delta_1 &= \frac{a_{k-1}^2}{2} - \frac{1}{4} (a_{k-1}^2 + a_k^2) (a_{k-1}^2 + b_k^2); \quad \gamma_2 = \frac{b_k^2}{2} - \frac{1}{4} (b_{k-1}^2 + b_k^2) (a_{k-1}^2 + b_k^2); \\
 \varepsilon_2 &= -\frac{a_k b_k}{2}; \quad \delta_2 = \frac{a_k^2}{2} - \frac{a_k^2}{4} (a_{k-1}^2 + a_k^2); \quad \chi = \frac{a_k^2}{4} (b_{k-1}^2 + b_k^2). \quad (5.73)
 \end{aligned}$$

From the explicit evaluation of Eqs. (5.70) and (5.72) for the different values of k , one can see that indeed the total amount of correlations of the mixed state given by Eq. (5.71) is smaller than the

correlations of the dressed states $|\Phi_{k-1}^- \rangle$ and $|\Phi_k^- \rangle$ giving its decomposition, which explains the emergence of the dips. Note however that the correlation measure given by $D(\rho_{SE}, \rho_S \otimes \rho_E)$ is not a convex function on the space of physical states, as explicitly shown in Appendix D.

The above arguments are summarized in Fig. (5.7). They explain the behavior of the correlations in the Gibbs state for small temperatures, i.e., for $\beta \rightarrow \infty$. The effect of finite temperatures is to smooth the dependence on g , as can be seen in Fig. (5.7), (5.6.e) and (5.6.d), such that the sudden increase at $g = \bar{g}_1$ is less sharp and that the subsequent dips turn into oscillations which are more and more suppressed as the temperature increases. This behavior is due to the fact that at finite temperature the Gibbs state has a non-vanishing admixture of $|\Phi_1^- \rangle$ for values of g which are smaller than \bar{g}_1 and, hence, the increase of the correlations starts before $g = \bar{g}_1$ and is less sharp, as can be seen from Figs. (5.7) and (5.6.e). Moreover, as a consequence of finite temperatures, the Gibbs state is a mixed state even between the critical values \bar{g}_k , such that its correlations become smaller than in the zero temperature limit, which leads to a suppression of the oscillations.

5.3.4 Gibbs initial state: time evolution of the trace distance

The analysis performed so far concerns the correlations of the initial Gibbs state, i.e., the upper bound of the trace distance between the reduced state $\rho_S^1(t)$, evolving from an initial total Gibbs state, and the reduced state $\rho_S^2(t)$, evolving from the corresponding product state, according to Eq. (5.26). We will now investigate the dynamics of the trace distance $D(\rho_S^1(t), \rho_S^2(t))$ and analyze, in particular, the dependence of the supremum of this function on the coupling constant and the temperature. As discussed before (see Sec. (5.1.3)), the behavior of the trace distance between $\rho_S^1(t)$ and $\rho_S^2(t)$ expresses the effect of initial correlations in the resulting dynamics. Moreover, its supremum as a function of time quantifies the amount of information which could not be initially retrieved by measurements on the reduced system only, but becomes accessible in the subsequent dynamics, thus making the two reduced states $\rho_S^1(t)$ and $\rho_S^2(t)$ more distinguishable.

Taking as initial state ρ_{SE}^1 the Gibbs state given by Eq. (5.55) and as ρ_{SE}^2 the product state of its marginals, we have $\rho_S^1(t) = \rho_S^1(0)$ since the Gibbs state is invariant under the time evolution, and $\rho_S^2(0) = \rho_S^2(0)$ because the corresponding open system initial states are identical. Thus, exploiting Eq. (5.63) we obtain the following explicit expression for the trace distance,

$$D(\rho_S^1(t), \rho_S^2(t)) = \left| (\rho_{00} - 1) \sum_n (n+1) \rho^{nn} |d_{n+1}(t)|^2 + \rho_{00} \sum_n n \rho^{nn} |d_n(t)|^2 \right|. \quad (5.74)$$

For fixed values of the parameters characterizing the dynamics this expression describes a superposition of periodic functions with incommensurable periods, i.e., an almost periodic function as already encountered in Sec. (5.3.2). An example for the trace distance dynamics is shown in Fig. (5.8). The trace distance starts growing already at the initial time and further oscillates with time, according to the almost periodic behavior described by Eq. (5.74).

As mentioned already, the time dependence of trace distance is solely due to the time evolution of the product state constructed from the marginals of the Gibbs state since the latter is invariant under the dynamics. It is the comparison between the two different reduced system states, namely between the states $\rho_S^1(t) = \rho_S^1(0)$ and $\rho_S^2(t)$, which allows to obtain information initially not

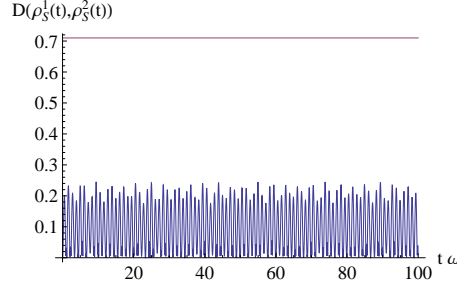

Figure 5.8: The trace distance $D(\rho_S^1(t), \rho_S^2(t))$ as a function of time according to Eq. (5.74); $\rho_S^i(t)$ is the state of the reduced system at time t obtained from a total initial state ρ_{SE}^i , where ρ_{SE}^1 is the Gibbs state given by Eq. (5.55) and ρ_{SE}^2 is the corresponding product state. The upper horizontal line represents the bound given by the right-hand side of the inequality (5.26) which has been determined by Eq. (5.68). Parameters: $\Delta/\omega = 1/6$, $g/\omega = 2$ and $\beta\omega = 15$.

accessible with measurement on the reduced system only, and which enables the detection of correlations in the initial Gibbs state.

The supremum of the trace distance in Fig. (5.8) is substantially smaller than the corresponding bound in Eq. (5.26). For large values of β and g the supremum can be estimated as follows. If the temperature goes to zero the Gibbs state approaches the projection onto the ground state which is given by $|\Phi_k^-\rangle\langle\Phi_k^-|$ for a fixed k , depending on the value of the coupling constant g . We suppose that g is different from the critical values \bar{g}_i . This implies $\rho_{00} = a_k^2$, $\rho_{11} = b_k^2$, together with $\rho^{mm} = \delta_{m,k}a_k^2 + \delta_{m,k-1}b_k^2$. For large values of g , which implies large values of k , we have $a_k \approx b_k \approx 1/\sqrt{2}$. Employing further Eqs. (3.53) and (3.54), one thus obtains the estimate

$$D(\rho_S^1(t), \rho_S^2(t)) \approx \frac{1}{4} \left| \sin(2\sqrt{k}gt) \sin(gt/\sqrt{k}) \right|. \quad (5.75)$$

This shows that for large β and g the trace distance is bounded from above by $\frac{1}{4}$.

Figure (5.9.a) shows how the supremum of $D(\rho_S^1(t), \rho_S^2(t))$ over time behaves as a function of the coupling constant g and the inverse temperature β , keeping fixed ω and Δ . Exactly as for the correlations of the Gibbs state [compare with Fig. (5.6.a)], we observe two qualitatively different kinds of behavior as a function of β , for a fixed value of g . Below a critical g the supremum of the trace distance passes through maximum and then tends to zero; above the critical value it tends monotonically to an asymptotic value which is close to the estimate of $\frac{1}{4}$ determined above, as illustrated in Figs. (5.9.b) and (5.9.c). Moreover, considering how the supremum of the trace distance varies as a function of g for fixed β , after a sudden growth at the first critical g it exhibits some oscillations analogous to those of the bound. Comparing Figs. (5.7) and (5.9.e), we see that in the limit of zero temperature the bound and the actual supremum of the trace distance both show a sudden increase and subsequent dips at the same values of the coupling constant g . This behavior can be explained by recalling the dependence of the energy spectrum of the Hamiltonian as a function of g in Fig. (5.7). At zero temperature the Gibbs state reduces to the ground level of the Hamiltonian. The discontinuous change in the ground level with varying g , i.e. the transition

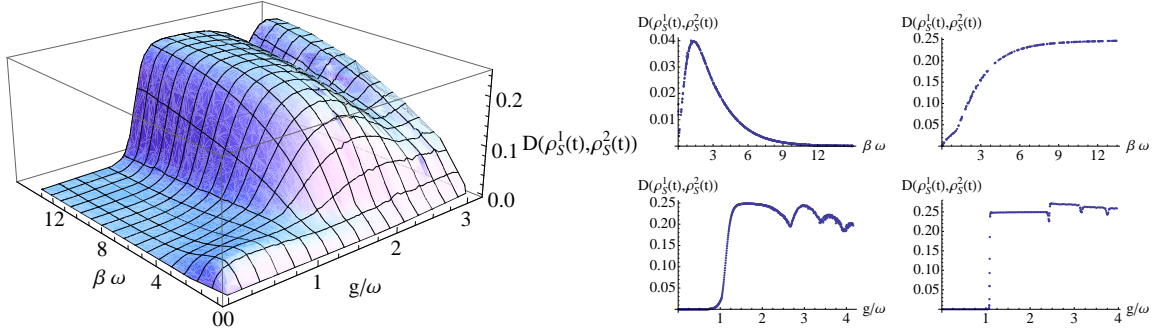

Figure 5.9: (a) The supremum of $D(\rho_S^1(t), \rho_S^2(t))$ as a function of time versus the coupling constant g and the inverse temperature β ; $\rho_S^1(t)$ is obtained from an initial total Gibbs state, $\rho_S^2(t)$ from the corresponding product state, $D(\rho_S^1(t), \rho_S^2(t))$ is calculated according to Eq. (5.74); $\Delta/\omega = 1/6$. (b, c, d, e From top left to bottom right) The same as Fig. (5.9.a) but for parameters $g/\omega = 0.57$, $g/\omega = 1.83$, $\beta\omega = 15$ and $\beta\omega = 300$, respectively. For $\beta\omega = 300$, i.e., approximately zero temperature, the dips occur at the same values as the corresponding dips of the bound, see Fig. (5.7). For the case of finite temperature the dips are not suppressed, but they are shifted towards larger values of g .

from $|\Phi_k\rangle$ to $(|\Phi_k\rangle + |\Phi_{k+1}\rangle)/\sqrt{2}$, implies a discontinuous change in the bound as well as in the supremum of the trace distance, thus leading to the dips appearing in Fig. (5.7) and Fig. (5.9.e). In fact, apart from fixing the bound at the r.h.s. of Eq. (5.26), the Gibbs state determines both reduced states $\rho_S^1(t)$ and $\rho_S^2(t)$, arising from the total initial states ρ_{SE} and $\rho_S \otimes \rho_E$ respectively. Relying on Eq. (5.45) one can see that for $\Delta = 0$ the supremum of the trace distance is simply given by $1/4$ for an initial correlated state $\rho_{SE} = |\Phi_k\rangle\langle\Phi_k|$, for any $k > 0$. This means that for zero detuning the supremum of the trace distance dynamics as a function of g at zero temperature takes the constant value $1/4$, except at $g = \bar{g}_k$ where the dips occur. The effect of a finite temperatures is slightly different for the bound and the supremum of the trace distance dynamics: with growing temperature the dips of the bound turn into oscillations which are more and more suppressed, but they occur at the same values of g . On the contrary, the dips of the supremum, and its sudden increase as well, are not suppressed, but do change position, occurring at larger values of g .

As concluding remarks, we want to emphasize that the comparison between the amount of correlations in the Gibbs state ρ_{SE} as it is quantified by $D(\rho_{SE}, \rho_S \otimes \rho_E)$, and the supremum of the trace distance between the open system states $\rho_S^1(t)$ and $\rho_S^2(t)$ which evolve from ρ_{SE} and $\rho_S \otimes \rho_E$, enabled us to establish a clear connection between the correlation properties of the Gibbs state and basic features of the subsequent open system dynamics, namely, the amount of information which is initially inaccessible for the open system and which is uncovered during its time evolution. As we have shown for the case at hand, at zero temperature sudden changes in the supremum over time of the trace distance can be traced back uniquely to discontinuous changes in the structure of the total system's ground state and to its degree of entanglement which, in turn, is caused by crossings of the energy levels of the total system Hamiltonian. It is important to remark that, as we have demonstrated, clear signatures of these discontinuities are still present at finite temperatures. Note that to reconstruct the trace distance dynamics, in order to detect correlation properties of the

ground state, one only needs to follow the evolution of the open system state obtained from the total initial product state $\rho_S \otimes \rho_E$.

Furthermore, the analysis performed in this section allows to conclude that the bound given by the right-hand side of Eq. (5.26) is able to represent qualitatively non-trivial behavior in the dynamics of the trace distance between $\rho_S^1(t)$ and $\rho_S^2(t)$, as a function of the different parameters characterizing the Hamiltonian and the temperature. While for the sudden transition between the two different asymptotic regimes as a function of β it is clear that the effective maximum of $D(\rho_S^1(t), \rho_S^2(t))$ has to reproduce the behavior of the bound, it is quite remarkable that also in the second case, where the bound is sensibly different from the effective maximum and from zero, both these quantities show an analogous non-monotonic behavior. Finally, we note that it must be expected that the general features found here for the correlated Gibbs state hold true also for other correlated initial states, e.g., for correlated non-equilibrium stationary states, as long as the latter involve discontinuous, qualitative changes under the variation of some system parameters.

Chapter 6

From Markovian dynamics on bipartite systems to non-Markovian dynamics on the subsystems

In this chapter, we further discuss non-Markovianity as well as initial correlations in the dynamics of open quantum systems, by taking into account a paradigmatic specific example. Namely, we consider the dynamics of a massive test particle with translational as well as internal degrees of freedom, interacting through collisions with a background ideal gas.

On the one hand, this allows us to present typical approximations leading to a semigroup description of open-system dynamics, see Sec. (3.3.1), in a concrete setting. On the other hand, the composite nature of the system under investigation clearly reveals how the feature of Markovian or non-Markovian dynamics cannot be a priori assigned to a given evolution, but it depends on where the border between the open system and the environment is placed, see Sec. (2.2.5). In fact, we show that the semigroup evolution involving both the translational and the internal degrees of freedom turns into a dynamics which exhibits strongly non-Markovian behaviors when the internal degrees of freedom are not resolved in the measurements and are averaged out, thus becoming part of the environment. A general mechanics to describe the transition from a Markovian dynamics on bipartite systems to non Markovian dynamics on the corresponding subsystems is provided by the generalized Lindblad structure [145, 165], that has been introduced in Sec. (5.1.2). This also allows to include in the reduced dynamics of a subsystem possible initial correlations with the other subsystem.

The dynamics of a massive test particle interacting through collisions with a background ideal gas is a paradigmatic model for the quantitative explanation of collisional decoherence, that has a central role in the general theory of decoherence because it seems to be the most natural and most effective kind of decoherence in the macroscopic world. It is worth emphasizing that recently very intensive research has been performed on decoherence due to collisions with a background gas in interferometry experiments with fullerenes, see e.g. [188, 189] and references therein. A thermal beam of fullerene molecules passes a suitably designed Talbot-Lau interferometer made up of three identical vertical gold gratings. When the pressure in the vacuum chamber containing the

interferometer is low enough, interference fringes can be recorded at the output of the interferometer: this represents a typical quantum feature of the observed particles. By raising the pressure, so that fullerenes might actually undergo collisions with the background gas while crossing the interferometer, the visibility of such interference fringes is rapidly reduced. This reduction is just a decoherence effect due to interaction of fullerenes with the environment, and, quite remarkably, experiments show how this transition is gradual.

In the first section, we present the physical system under investigation, that is, a massive particle with both translational and internal degrees of freedom subjected to a collisional dynamics with a low density background gas. First, we introduce the Lindblad equation that, under suitable approximations, describes the dynamics of the massive particle. Then, we take into account the situation in which the internal state of the massive particle is not resolved at the output of the interferometer. In this case, the internal degrees of freedom can be considered as part of the environment and the resulting reduced dynamics on translational degrees of freedom is characterized in terms of a generalized Lindblad structure. Since the latter holds for any initial state of internal and translational degrees of freedom, thus including possible initial correlations between them, in general it does not fix a family of reduced dynamical maps, as follows from the discussion of Secs. (5.1.1) and (5.1.2). Indeed, one can define such a family of dynamical maps on the state space of the translational degrees of freedom if the initial state is assumed to be a product state. We provide some representative examples, in the cases of elastic collisions as well as for a two-level system. For the latter situation, by neglecting the Hamiltonian part of the equation of motion, we also derive a closed homogeneous integrodifferential master equation for the reduced statistical operator, as well as a stochastic interpretation of the corresponding evolution map.

In the second section, we focus on the non-Markovian features of the dynamics introduced in the first section. First, we describe how the interplay between internal and motional states can influence the visibility in an interferometric setup for the study of decoherence, leading to a reduction of the visibility of the interference fringes that differs from the exponential decay, typically observed in semigroup dynamics. In particular, by means of simple examples, we highlight the effects of increasing the number of internal degrees of freedom, as well as the effects of inelastic collisions in a two-level system. Therefore, we justify, for the model at hand, the usual intuition that associates oscillations in the visibility evolution to a non-Markovian dynamics. In fact, we show how non-monotonic behaviors of visibility can be connected to analogous behaviors of trace distance, indicating a back flow of information to the translational degrees of freedom, see Sec. (4.2) and Appendix E. Indeed, in this case the non-Markovianity of the dynamics is due to the inclusion of the internal degrees of freedom into the environment, so that the initial semigroup dynamics of the massive particle, fixed by the corresponding Lindblad equation, turns into a non-Markovian dynamics on its subsystem consisting in the translational degrees of freedom alone.

6.1 Collisional dynamics of a particle with translational and internal degrees of freedom

6.1.1 Physical model and master equation on the bipartite system

In recent times, major advances in the experimental techniques have led to the realization of experiments in which quantum systems in a single particle regime are studied under their controlled interaction with some environment. A paradigmatic example in this context is given by the motion of a massive particle in an interferometric setup, which gives rise to interference fringes as typical quantum signatures. When the coupling with the environment becomes of relevance, such interference fringes are gradually washed out. As mentioned in the introduction, this phenomenon is usually referred to as decoherence [1, 2]. Its understanding and theoretical description require on the one hand a control over the environment, on the other hand a microscopic model for the interaction and the ensuing dynamics.

A common source of decoherence in an interferometric setup is represented by the collisions of the particle under study with a background gas [188]. Here, we consider in particular the evolution of a massive particle with mass M , with both translational and internal degrees of freedom, that interacts through collisions with a low density background gas of particles with mass m . The Hilbert space associated with the massive particle is thus $L^2(\mathbb{R}^3) \otimes \mathbb{C}^n$, where the infinite dimensional Hilbert space $L^2(\mathbb{R}^3)$ is associated with the translational degrees of freedom, while \mathbb{C}^n is associated with the internal degrees of freedom. The first step in order to derive a master equation for the dynamics of the massive particle is to consider a product total initial state, i.e., the massive particle and the background gas are assumed to be initially uncorrelated. This hypothesis is here justified since in usual interferometric settings the preparation of the initial state can be thought as separated from the interaction with the gas, see the discussion in the introduction to Chapter 5. The initial state of the gas is supposed to be stationary, with momentum distribution $\mu(\mathbf{p})$ and density n_{gas} . Furthermore, we assume that the collision time is much smaller than the time between two subsequent collisions, so that the dynamics can be described in terms of individually well-defined scattering events, and that three-particle collisions are sufficiently unlikely to be safely neglected. The collisions of the massive particle are characterized by the multichannel complex scattering amplitudes $f_{kj}(\mathbf{p}_f, \mathbf{p}_i)$ [190], which depend on the microscopic two-body interaction potential and describe the scattering from an initial momentum \mathbf{p}_i and internal state j to a final state with momentum \mathbf{p}_f and internal state k . The various channels correspond to the different internal states. For the model at hand, the Markov condition, see Sec. (3.3.1), is put into effect by treating subsequent collisions between the massive particle and particles of the gas as independent [191, 192, 193]. Before a new collision, the latter have already lost their correlations due to the previous scattering event. This means that the decay time τ_E of the environmental correlation functions is much smaller than the time τ_R between subsequent collisions, compare with Eq. (3.110) and the related discussion. Note that these assumptions exclude liquified or strongly self-interacting gas environments, but they seem to be natural in the case of a low density stationary gas. Nevertheless, in order to obtain a semigroup description of the reduced dynamics, one needs for few further approximations [29], the most relevant corresponding to a separation of time scales between internal and translational dynamics.

Under these hypothesis, one comes to a master equation in Lindblad form [29]. For the sake of simplicity, we report here the limiting case corresponding to $m/M \rightarrow 0$, that is, the test particle is much more massive than the particles of the background gas, as typical in interferometric experiments with fullerenes. The Lindblad master equation then reads

$$\frac{d}{dt}\rho(t) = \frac{1}{i\hbar} [H_0 + H_n, \rho(t)] + \sum_{\varepsilon} \int d\mathbf{Q} \int_{\mathbf{Q}_{\perp}} d\mathbf{p} \left(L_{\mathbf{Q},\mathbf{p},\varepsilon} \rho(t) L_{\mathbf{Q},\mathbf{p},\varepsilon}^{\dagger} - \frac{1}{2} \left\{ L_{\mathbf{Q},\mathbf{p},\varepsilon}^{\dagger} L_{\mathbf{Q},\mathbf{p},\varepsilon}, \rho(t) \right\} \right), \quad (6.1)$$

where

$$H_0 = \frac{\mathbf{P}^2}{2M} + H_0^{\text{int}} = \frac{\mathbf{P}^2}{2M} + \sum_k E_k |u_k\rangle \langle u_k| \quad (6.2)$$

is the free energy of the massive particle, with \mathbf{P} its momentum operator and H_0^{int} its free internal energy, while the Lindblad operators are given by

$$L_{\mathbf{Q},\mathbf{p},\varepsilon} = \sum_{\substack{kj \\ \varepsilon_{kj}=\varepsilon}} L_{kj}(\mathbf{p}, \mathbf{Q}) e^{i\mathbf{Q}\cdot\mathbf{X}/\hbar} \otimes e_{kj}, \quad (6.3)$$

with

$$L_{kj}(\mathbf{p}, \mathbf{Q}) = \sqrt{\frac{n_{\text{gas}}}{mQ}} \sqrt{\mu \left(\mathbf{p}_{\perp} + \frac{\mathbf{Q}}{2} + \frac{\mathbf{Q}\varepsilon_{kj}}{Q^2/m} \right)} f_{kj} \left(\mathbf{p}_{\perp} - \frac{\mathbf{Q}}{2} + \frac{\mathbf{Q}\varepsilon_{kj}}{Q^2/m}, \mathbf{p}_{\perp} + \frac{\mathbf{Q}}{2} + \frac{\mathbf{Q}\varepsilon_{kj}}{Q^2/m} \right), \quad (6.4)$$

where \mathbf{X} is the position operator of the massive particle, so that the exponential factor describes momentum exchanges according to $\exp(i\mathbf{Q}\cdot\mathbf{X}/\hbar)|\mathbf{P}\rangle = |\mathbf{P} + \mathbf{Q}\rangle$, while $\varepsilon_{kj} = E_k - E_j$ denotes the difference between the eigenvalues of the free internal energy H_0^{int} , and e_{kj} is the standard operator basis, as in Eq. (2.52), constructed from the corresponding eigenvectors $\{|u_k\rangle_{k=1,\dots,n}\}$. Note that the Lindblad operators essentially depend on the scattering amplitudes and the momentum distribution of the gas, thus keeping into account all the details of the collisional interaction. Furthermore, the restriction of \mathbf{p} -integration to the plane $\mathbf{Q}_{\perp} = \{\mathbf{p} \in \mathbb{R}^3 : \mathbf{p}\cdot\mathbf{Q} = 0\}$ in Eq. (6.1), as well as the dependence on both the exchanged momentum \mathbf{Q} and the gas-particle momentum \mathbf{p} in Eq. (6.4), are fixed by energy and momentum conservation. Finally, the interaction of the massive particle with the environment induces an Hamiltonian contribution H_n to the reduced dynamics, of the form

$$H_n = -2\pi\hbar^2 \frac{n_{\text{gas}}}{m} \sum_{\substack{kj \\ \varepsilon_{kj}=0}} \int d\mathbf{p}_0 \mu(\mathbf{p}_0) \text{Re} [f_{kj}(\mathbf{p}_0, \mathbf{p}_0)] e_{kj}. \quad (6.5)$$

6.1.2 Generalized Lindblad structure on translational degrees of freedom

The quantum master equation (6.1) is in Lindblad form: when both translational and internal degrees of freedom are detected, the dynamics of the massive particle is Markovian, in the sense that has been widely discussed in Sec. (4.2). A different situation emerges if the translational or

the internal degrees of freedom, although influencing the collisional dynamics, are not revealed during the measurement process. In this case they can be averaged out from the description of the system, by means of partial trace, thus becoming part of the environment. As will be explicitly shown in the next section, the resulting reduced dynamics for translational degrees of freedom generally presents strongly non-Markovian behaviors. A non-Markovian dynamical regime becomes Markovian by suitably enlarging the set of degrees of freedom¹ and vice-versa. Indeed, a unitary Markovian time evolution for both system and reservoir generally gives a non-Markovian reduced dynamics for the system, the degree of non-Markovianity of the description also depending on where we set the border between system and environment, which ultimately depends on the physical quantities actually measurable in the experiment. A smaller set of observed degrees of freedom, with respect to those actually involved in the dynamics, can lead from a Markovian to a non-Markovian regime. As said in the introduction to this chapter, a general mechanism describing this transition in quantum systems is provided by the generalized Lindblad structure [145]: a Lindblad structure on a bipartite system can generate in the two reduced subsystems a generalized Lindblad structure, typically describing a non-Markovian dynamics [165].

In the situation we are considering, the bipartite system is formed by translational and internal degrees of freedom of the massive particle. If the measurements at the output of the detector cannot probe the internal degrees of freedom, the only experimentally accessible quantities are expectations or matrix elements of the statistical operator that describes the state of translational degrees of freedom and that is given by

$$\varrho(t) = \text{tr}_{\mathbb{C}^n} \{ \rho(t) \} = \sum_k \langle u_k | \rho(t) | u_k \rangle =: \sum_k \rho_k(t), \quad (6.6)$$

where $\{|u_k\rangle\}_{k=1,\dots,n}$ is a basis of \mathbb{C}^n , $\rho(t)$ is the statistical operator describing the full state of the massive particle and then $\{\rho_k(t)\}_{k=1,\dots,n}$ is a collection of unnormalized positive trace class operators on $L^2(\mathbb{R}^3)$. It is easy to see that, if the free Hamiltonian is non degenerate, the diagonal matrix elements in the energy basis with respect to the internal degrees of freedom of Eq. (6.1) lead to the following coupled system of homogeneous equations:

$$\frac{d}{dt} \rho_k(t) = \frac{1}{i\hbar} \left[\frac{\mathbf{P}^2}{2M}, \rho_k(t) \right] + \sum_j \left(\Gamma^{kj} \int d\mathbf{Q} \mathcal{P}^{kj}(\mathbf{Q}) e^{i\mathbf{Q}\cdot\mathbf{X}/\hbar} \rho_j(t) e^{-i\mathbf{Q}\cdot\mathbf{X}/\hbar} - \Gamma^{jk} \rho_k(t) \right), \quad (6.7)$$

with $\mathcal{P}^{kj}(\mathbf{Q})$ and Γ^{jk} given by, respectively,

$$\mathcal{P}^{kj}(\mathbf{Q}) := \frac{M_{kj}(\mathbf{Q})}{\int d\mathbf{Q} M_{kj}(\mathbf{Q})} \quad (6.8)$$

and

$$\Gamma^{kj} := \int d\mathbf{Q} M_{kj}(\mathbf{Q}), \quad (6.9)$$

¹In [194] this is explicitly shown for the dynamics of a quantum Brownian particle, by recasting the total system in a semi-infinite chain with nearest-neighbor interaction.

where we have set, see Eq. (6.4),

$$M_{kj}(\mathbf{Q}) = \int_{\mathbf{Q}_\perp} d\mathbf{p} |L_{kj}(\mathbf{p}, \mathbf{Q})|^2. \quad (6.10)$$

This system of equations has a generalized Lindblad structure, see Eq. (5.21) with the identification $\lambda \rightarrow \mathbf{Q}$, $H^k \rightarrow P^2/2M$ and $R_\lambda^{kj} \rightarrow \sqrt{\Gamma^{kj} \mathcal{P}^{kj}(\mathbf{Q})} e^{i\mathbf{Q} \cdot \mathbf{X}/\hbar}$. Note that the positive quantities $M_{kj}(\mathbf{Q})$ can be seen as transition rates [29], so that $\mathcal{P}^{kj}(\mathbf{Q})$ can be interpreted as the classical probability distribution that the scattering between a massive particle and a particle of the gas induces a momentum exchange \mathbf{Q} , as well as a transition of the massive particle from the internal energy eigenstate $|u_j\rangle$ to the internal state $|u_k\rangle$. On the same footing, Γ^{kj} can be interpreted as the total transition rate for a massive particle with internal state $|u_j\rangle$ to go to a fixed final internal energy eigenstate $|u_k\rangle$.

Let us note that the same generalized Lindblad structure in Eq. (6.7) can be associated with a semiclassical dynamics of the massive particle, where the internal degrees of freedom are treated classically [29]. In fact, consider the Lindblad structure in Eq. (6.1), but restricted to block diagonal states $\rho_{SE}(t)$, see Eq. (5.18), of the form²

$$\rho_{SE}(t) = \sum_k \rho_k(t) \otimes |u_k\rangle\langle u_k|, \quad (6.11)$$

with respect to the basis $\{|u_k\rangle\}_{k=1,\dots,n}$ of eigenvectors of the free Hamiltonian H_0^{int} and with $\rho_k(t)$ positive trace class operators on $L^2(\mathbb{R}^3)$. These states provide a semiclassical description of the massive particle, in which internal degrees of freedom are treated classically, in the sense that superposition of states of the free Hamiltonian eigenvectors are excluded, i.e., for $k \neq k'$ one has

$$\langle \psi, u_k | \rho_{SE}(t) | \varphi, u_{k'} \rangle = 0 \quad | \psi \rangle, | \varphi \rangle \in L^2(\mathbb{R}^3). \quad (6.12)$$

In concrete situations, this can be justified, e.g., when decoherence affects more strongly, or equivalently on a shorter time scale, the center of mass degrees of freedom [165, 195], so that the full state $\rho(t)$ of the massive particle has a block diagonal structure. Then, it is easy to see [29] that the collection $\{\rho_k(t)\}_{k=1,\dots,n}$ of positive trace class operators on $L^2(\mathbb{R}^3)$ defined in Eq. (6.11) satisfies the generalized Lindblad structure in Eq. (6.7). Furthermore, let us take the trace with respect to the translational degrees of freedom, thus getting

$$\frac{d}{dt} p_k(t) = \sum_j \left(\Gamma^{kj} p_j(t) - \Gamma^{jk} p_k(t) \right), \quad (6.13)$$

where we defined through

$$p_k(t) \equiv \text{Tr}_{L^2(\mathbb{R}^3)}[\rho_k(t)] \quad (6.14)$$

²Starting from the generalized Lindblad structure in Eq. (6.7), the Lindblad structure in Eq. (6.1) can be seen as the Lindblad structure on an extended Hilbert space introduced in Sec. (5.1.2), that preserves the block diagonal structure, see Eq. (5.20). Note that here the auxiliary Hilbert space is identified with the Hilbert space associated with the internal degrees of freedom.

the elements of a classical one-point probability distribution, see Sec. (4.1.1), associated with the internal degrees of freedom. Due to the positivity of the transition rates Γ^{kj} , we can conclude that this one-point probability distribution satisfies a Pauli master equation with time-independent coefficients, see Eq. (4.5). Summarizing, Eq. (6.7) can be thought as referred to a semiclassical description of the massive particle, in which the internal degrees of freedom are described by a classical probability vector that obeys a Pauli master equation [161].

Nevertheless, it is worth emphasizing that in order to derive Eq. (6.7) from the Lindblad equation (6.1), we did *not* assume a classical dynamics for the internal degrees of freedom or rather a block diagonal structure as in Eq. (6.11). Instead, we focused on the diagonal matrix elements of the internal states only since the latter are enough to determine the dynamics of the motional state according to Eq. (6.6). The generalized Lindblad structure is compatible with both a semiclassical dynamics of the massive particle and a nontrivial dynamics also for the off-diagonal elements with respect to the eigenvectors of the free internal Hamiltonian. Indeed, the presence of such a dynamics has to be checked by measurements on the internal degrees of freedom, but, in any case, it does not influence the reduced dynamics of the translational degrees of freedom.

6.1.3 Evolution in position representation

The generalized Lindblad structure in Eq. (6.7) represents a coupled system of equations for the collection $\{\rho_k(t)\}_{k=1,\dots,n}$ of unnormalized trace class operators on $L^2(\mathbb{R}^3)$. As discussed in Sec. (5.1.2), this system of equations does not define a family of reduced dynamical maps. In fact, only from the knowledge of the entire collection $\{\rho_k(0)\}_{k=1,\dots,n}$ of initial trace class operators, the generalized Lindblad structure yields the collection $\{\rho_k(t)\}_{k=1,\dots,n}$ at time t and then, through Eq. (6.6), also $\varrho(t)$. Actually, Eq. (6.7) has been derived from Eq. (6.1) without any assumption about the initial state $\rho(0)$ involving both translational and internal degrees of freedom. But since now we are focusing only the dynamics of the former, while the latter are part of the environment, this implies that we are including in our description of reduced dynamics the possibility of initial system-environment correlations. Therefore, the definition of a family of reduced dynamical maps on the state space of the translational degrees of freedom of the massive particle is not unique and it would require specific procedures, see Secs. (5.1.1) and (5.1.2). On the other hand, if we assume that the translational and internal degrees of freedom are initially uncorrelated, i.e. $\rho(0) = \varrho(0) \otimes \sigma(0)$, so that

$$\rho_k(0) = p_k \varrho(0) \quad p_k \equiv \langle u_k | \sigma(0) | u_k \rangle, \quad (6.15)$$

it is then possible to define a family of reduced dynamical maps for the translational degrees of freedom. Indeed, these maps will depend on the initial state of the environment $\sigma(0)$ through the parameters p_k . To be explicit, let us consider in the following some representative examples.

We achieve the solution of Eq. (6.7) in position representation, also because this will turn out to be useful in order to calculate the visibility behavior in Sec. (6.2.1). Starting from Eq. (6.7), we

obtain

$$\begin{aligned} \frac{d}{dt}\rho_k(\mathbf{X}, \mathbf{X}', t) &= \frac{1}{i\hbar}(\Delta_{\mathbf{X}} - \Delta_{\mathbf{X}'})\rho_k(\mathbf{X}, \mathbf{X}', t) \\ &+ \sum_j \left(\Gamma^{kj} \Phi^{kj}(\mathbf{X} - \mathbf{X}') \rho_j(\mathbf{X}, \mathbf{X}', t) - \Gamma^{jk} \rho_k(\mathbf{X}, \mathbf{X}', t) \right), \end{aligned} \quad (6.16)$$

where $\rho_k(\mathbf{X}, \mathbf{X}', t)$ denotes the matrix element $\langle \mathbf{X} | \rho_k(t) | \mathbf{X}' \rangle$ and $\Phi^{kj}(\mathbf{X} - \mathbf{X}')$ is the characteristic function of the probability density $\mathcal{P}^{kj}(\mathbf{Q})$ [113], i.e., its Fourier transform

$$\Phi^{kj}(\mathbf{X} - \mathbf{X}') = \int d\mathbf{Q} e^{i(\mathbf{X} - \mathbf{X}') \cdot \mathbf{Q} / \hbar} \mathcal{P}^{kj}(\mathbf{Q}). \quad (6.17)$$

We will now consider a few cases in which Eq. (6.16) can be solved analytically.

Elastic collisions for an N-level system

When the collisions are purely elastic, so that they do not lead to transitions between different internal states, the scattering rates satisfy $\Gamma^{kj} = \delta_{kj} \Gamma^{kk}$. This is the case when the energy exchanges involved in the single collisions are much smaller than the typical separation of the internal energy levels [195]. The equations for the different ρ_k then become uncoupled and take the form

$$\frac{d}{dt}\rho_k(\mathbf{X}, \mathbf{X}', t) = \frac{1}{i\hbar}(\Delta_{\mathbf{X}} - \Delta_{\mathbf{X}'})\rho_k(\mathbf{X}, \mathbf{X}', t) - \Gamma^{kk}(1 - \Phi^{kk}(\mathbf{X} - \mathbf{X}'))\rho_k(\mathbf{X}, \mathbf{X}', t). \quad (6.18)$$

The latter equation can be conveniently solved by introducing the characteristic function [196]

$$\chi_k(\boldsymbol{\lambda}, \boldsymbol{\mu}, t) := \text{Tr} \left\{ \rho_k(t) e^{i(\boldsymbol{\lambda} \cdot \mathbf{X} + \boldsymbol{\mu} \cdot \mathbf{P}) / \hbar} \right\}, \quad (6.19)$$

where \mathbf{X} and \mathbf{P} as usual denote position and momentum operators of the massive particle. In such a way Eq. (6.18) leads to

$$\partial_t \chi_k(\boldsymbol{\lambda}, \boldsymbol{\mu}, t) = \left[\frac{\boldsymbol{\lambda}}{M} \cdot \partial_{\boldsymbol{\mu}} - \Gamma^{kk}(1 - \Phi^{kk}(\boldsymbol{\mu})) \right] \chi_k(\boldsymbol{\lambda}, \boldsymbol{\mu}, t), \quad (6.20)$$

which is an equation of first order solved by

$$\chi_k(\boldsymbol{\lambda}, \boldsymbol{\mu}, t) = \chi_k^0(\boldsymbol{\lambda}, \boldsymbol{\lambda}t/M + \boldsymbol{\mu}) e^{-\Gamma^{kk} \int_0^t (1 - \Phi^{kk}(\boldsymbol{\lambda}(t-t')/M + \boldsymbol{\mu})) dt'}, \quad (6.21)$$

where $\chi_k^0(\boldsymbol{\lambda}, \boldsymbol{\lambda}t/M + \boldsymbol{\mu})$ obeys the free equation $\partial_t \chi_k(\boldsymbol{\lambda}, \boldsymbol{\mu}, t) = (\boldsymbol{\lambda}/M) \cdot \partial_{\boldsymbol{\mu}} \chi_k(\boldsymbol{\lambda}, \boldsymbol{\mu}, t)$. Inverting Eq. (6.19) by taking the Fourier transform with respect to $\boldsymbol{\lambda}$,

$$\rho_k(\mathbf{X}, \mathbf{X}', t) = \int \frac{d\boldsymbol{\lambda}}{(2\pi\hbar)^3} e^{-i\boldsymbol{\lambda} \cdot (\mathbf{X} + \mathbf{X}') / 2\hbar} \chi_k(t, \boldsymbol{\lambda}, \mathbf{X} - \mathbf{X}'), \quad (6.22)$$

we obtain the exact solution

$$\rho_k(\mathbf{X}, \mathbf{X}', t) = \int \frac{d\mathbf{s} d\boldsymbol{\lambda}}{(2\pi\hbar)^3} e^{-i\boldsymbol{\lambda} \cdot \mathbf{s} / \hbar} e^{-\Gamma^{kk} \int_0^t (1 - \Phi^{kk}(\boldsymbol{\lambda}(t-t')/M + \mathbf{X} - \mathbf{X}')) dt'} \rho_k^0(\mathbf{X} + \mathbf{s}, \mathbf{X}' + \mathbf{s}, t)$$

expressed in terms of an integral of the freely evolved subcollections $\rho_k^0(\mathbf{X}, \mathbf{X}', t)$ with a suitable kernel, where we have set

$$\begin{aligned}\rho_k^0(\mathbf{X}, \mathbf{X}', t) &= \int \frac{d\boldsymbol{\lambda}}{(2\pi\hbar)^3} e^{-i\boldsymbol{\lambda}\cdot(\mathbf{X}+\mathbf{X}')/2\hbar} \chi_k^0(\boldsymbol{\lambda}, \mathbf{X} - \mathbf{X}', t) \\ &= \langle \mathbf{X} | \exp\left(-\frac{i}{\hbar} \frac{\mathbf{P}^2}{2M} t\right) \rho_k(0) \exp\left(\frac{i}{\hbar} \frac{\mathbf{P}^2}{2M} t\right) | \mathbf{X}' \rangle\end{aligned}\quad (6.23)$$

and $\rho_k(0) = \langle u_k | \rho(0) | u_k \rangle$. Indeed, Eq. (6.23) corresponds to the unitary free evolution $\mathcal{U}_0(t)$, such that $\varrho^0(t) = \mathcal{U}_0(t)\varrho^0(0)$. The evolution of the statistical operator given by Eq. (6.6) is obtained by summing the different $\rho_k(\mathbf{X}, \mathbf{X}', t)$ over the discrete index k . In general, this does not define a dynamical map on the state space of translational degrees of freedom, since from the mere knowledge of $\varrho(0) = \sum_k \rho_k(0)$ one cannot get any information about the individual $\rho_k(0)$ and then neither about the individual $\rho_k^0(\mathbf{X}, \mathbf{X}', t)$. However, if the initial state is given by a product state between the translational and the internal part, i.e. Eq. (6.15) holds, we get

$$\begin{aligned}\varrho(\mathbf{X}, \mathbf{X}', t) &= \sum_k p_k \int \frac{ds d\boldsymbol{\lambda}}{(2\pi\hbar)^3} e^{-i\boldsymbol{\lambda}\cdot\mathbf{s}/\hbar} \\ &\quad \times e^{-\Gamma^{kk} \int_0^t (1 - \Phi^{kk}(\boldsymbol{\lambda}(t-t')/M + \mathbf{X} - \mathbf{X}')) dt'} \varrho^0(\mathbf{X} + \mathbf{s}, \mathbf{X}' + \mathbf{s}, t).\end{aligned}\quad (6.24)$$

This expression, together with the unitary evolution $\mathcal{U}_0(t)$ defined in Eq. (6.23), fixes a family of reduced dynamical maps $\{\Lambda(t, 0)\}_{t \geq 0}$ such that

$$\varrho(\mathbf{X}, \mathbf{X}', t) = \langle \mathbf{X} | \Lambda(t, 0) \varrho(0) | \mathbf{X}' \rangle. \quad (6.25)$$

Furthermore, note that this reduces to a semigroup evolution when either only one p_k is different from zero (and therefore equal to one), or the rates are all equal. This limiting cases describes situations in which the initial state is in a specific internal state or the collisions do not depend on the internal state of the tracer particle. In the next section we will see how, in general, Eq. (6.24) describes a non-Markovian dynamics, even when every single trace class operator $\rho_k(t)$ follows a semigroup dynamics.

Two-level system

For the case of a two-level system a natural situation corresponds to inelastic scattering taking place only when the massive particle gets de-excited, so that only one of the two scattering rates is different from zero. This case can still be treated analytically. Assuming $\Gamma^{21} = 0$, the equation for $\chi_2(t, \boldsymbol{\lambda}, \boldsymbol{\mu})$ gets closed, and it is solved by

$$\chi_2(\boldsymbol{\lambda}, \boldsymbol{\mu}, t) = \chi_2^0(\boldsymbol{\lambda}, \boldsymbol{\lambda}t/M + \boldsymbol{\mu}) e^{-\Gamma^{12}t} e^{-\Gamma^{22} \int_0^t (1 - \Phi^{22}(\boldsymbol{\lambda}(t-t')/M + \boldsymbol{\mu})) dt'}. \quad (6.26)$$

The equation for $\chi_1(\boldsymbol{\lambda}, \boldsymbol{\mu}, t)$ then reads

$$\partial_t \chi_1(\boldsymbol{\lambda}, \boldsymbol{\mu}, t) = \left[\frac{\boldsymbol{\lambda}}{M} \cdot \partial_{\boldsymbol{\mu}} - \Gamma^{11}(1 - \Phi^{11}(\boldsymbol{\mu})) \right] \chi_1(\boldsymbol{\lambda}, \boldsymbol{\mu}, t) + \Gamma^{12} \Phi^{12}(\boldsymbol{\mu}) \chi_2(\boldsymbol{\lambda}, \boldsymbol{\mu}, t) \quad (6.27)$$

and its solution is given by

$$\begin{aligned} \chi_1(\boldsymbol{\lambda}, \boldsymbol{\mu}, t) = & e^{-\Gamma^{11} \int_0^t (1-\Phi^{11}(\boldsymbol{\lambda}(t-t')/M+\boldsymbol{\mu})) dt'} \left\{ \chi_1^0(\boldsymbol{\lambda}, \boldsymbol{\lambda}t/M + \boldsymbol{\mu}) \right. \\ & + \Gamma^{12} \int_0^t \left[e^{\Gamma^{11} \int_0^{t'} (1-\Phi^{11}(\boldsymbol{\lambda}(t-t'')/M+\boldsymbol{\mu})) dt''} \right. \\ & \left. \left. \times \Phi^{12}(\boldsymbol{\lambda}(t-t')/M + \boldsymbol{\mu}) \chi_2(t', \boldsymbol{\lambda}, \boldsymbol{\lambda}(t-t')/M + \boldsymbol{\mu}) \right] dt' \right\}. \end{aligned} \quad (6.28)$$

This formula explicitly shows that $\chi_1(\boldsymbol{\lambda}, \boldsymbol{\mu}, t)$ depends on the function $\chi_2(\boldsymbol{\lambda}, \boldsymbol{\mu}, \cdot)$ evaluated over the whole time interval between 0 and t , a typical signature of non-Markovian dynamics. Assuming once again that the initial state satisfies Eq. (6.15), the statistical operator describing the translational degrees of freedom of the massive particle is given at time t by the expression

$$\begin{aligned} \varrho(\mathbf{X}, \mathbf{X}', t) = & \int \frac{d\mathbf{s}d\boldsymbol{\lambda}}{(2\pi\hbar)^3} e^{-i\boldsymbol{\lambda}\cdot\mathbf{s}/\hbar} \varrho^0(\mathbf{X} + \mathbf{s}, \mathbf{X}' + \mathbf{s}, t) \left\{ p_2 e^{-\Gamma^{12}t} e^{-\Gamma^{22} \int_0^t (1-\Phi^{22}(\boldsymbol{\lambda}(t-t')/M+\mathbf{X}-\mathbf{X}')) dt'} \right. \\ & + p_1 e^{-\Gamma^{11} \int_0^t (1-\Phi^{11}(\boldsymbol{\lambda}(t-t')/M+\mathbf{X}-\mathbf{X}')) dt'} + p_2 \Gamma^{12} e^{-\Gamma^{11} \int_0^t (1-\Phi^{11}(\boldsymbol{\lambda}(t-t')/M+\mathbf{X}-\mathbf{X}')) dt'} \\ & \times \int_0^t \left(e^{-\Gamma^{12}t'} e^{-\Gamma^{22} \int_0^{t'} (1-\Phi^{22}(\boldsymbol{\lambda}(t-t'')/M+\mathbf{X}-\mathbf{X}')) dt''} e^{\Gamma^{11} \int_0^{t'} (1-\Phi^{11}(\boldsymbol{\lambda}(t-t'')/M+\mathbf{X}-\mathbf{X}')) dt''} \right. \\ & \left. \left. \times \Phi^{12}(\boldsymbol{\lambda}(t-t')/M + \mathbf{X} - \mathbf{X}') \right) dt' \right\}. \end{aligned} \quad (6.29)$$

6.1.4 From generalized Lindblad structure to integrodifferential master equation

We have thus seen that if the internal and the translational degrees of freedom are initially uncorrelated, the reduced evolution of the latter can be described by means of dynamical maps. The approach introduced in Sec. (3.1.2) provides us the corresponding closed master equation for the full reduced statistical operator $\varrho(t)$ of the translational degrees of freedom.

Consider the case of elastic collisions and let us neglect the Hamiltonian contribution to the equations of motion. Then, the family of reduced dynamical maps fixed by Eq. (6.7) is simply given by a convex mixture of semigroup evolutions, according to

$$\Lambda(t, 0) = \sum_{k=1}^n p_k e^{L_k t}, \quad (6.30)$$

where

$$L_k \rho(t) = \Gamma^{kk} \left(\int d\mathbf{Q} \mathcal{P}^{kk}(\mathbf{Q}) e^{i\mathbf{Q}\cdot\mathbf{X}/\hbar} \rho(t) e^{-i\mathbf{Q}\cdot\mathbf{X}/\hbar} - \rho(t) \right) \quad (6.31)$$

for³ $k = 1, \dots, n$. Note that, since $[L_k, L_j] = 0$ for any k and j , $\Lambda(t, 0)$ in Eq. (6.30) is completely positive and, furthermore, the dynamical maps at different times commute [48], see also Sec. (3.1.2). The Laplace transform of Eq. (6.30) is

$$\widehat{\Lambda}(u) = \sum_{k=1}^n \frac{p_k}{u - L_k}, \quad (6.32)$$

³The map in Eq. (6.30) is well defined since we are considering bounded generators L_k , see Eq. (B.11).

so that by using Eq. (3.23), one easily gets [197, 68]

$$\widehat{K}_{\text{NZ}}(u) = \frac{\sum_k p_k L_k (u - L_k)^{-1}}{\sum_k p_k (u - L_k)^{-1}}. \quad (6.33)$$

For a two level system, i.e. $n = 2$, this reduces to

$$\widehat{K}_{\text{NZ}}(u) = p_1 L_1 + p_2 L_2 + p_1 p_2 \frac{(L_1 - L_2)^2}{u - p_1 L_2 - p_2 L_1}, \quad (6.34)$$

and then, by coming back to the temporal domain, one gets the integrodifferential master equation

$$\frac{d}{dt} \varrho(t) = (p_1 L_1 + p_2 L_2) \varrho(t) + p_1 p_2 (L_1 - L_2)^2 \int_0^t d\tau e^{(p_1 L_2 + p_2 L_1)(t-\tau)} \varrho(\tau). \quad (6.35)$$

This equation, for specific choices of L_2 , has been used in [198] to study the asymptotic state of non-Markovian dynamics. In order to illustrate the growing complexity of the memory kernel with the increasing of the dimensions associated with internal degrees of freedom, let us present the master equation for $n = 3$. It reads

$$\begin{aligned} \frac{d}{dt} \varrho(t) = & L \varrho(t) + \int_0^t d\tau \left\{ A \cosh \left(\sqrt{C^2 - 4D} \frac{t-\tau}{2} \right) \right. \\ & \left. + \frac{2B + AC}{\sqrt{C^2 - 4D}} \sinh \left(\sqrt{C^2 - 4D} \frac{t-\tau}{2} \right) \right\} e^{\frac{C}{2}(t-\tau)} \varrho(\tau). \end{aligned} \quad (6.36)$$

with

$$\begin{aligned} L &= p_1 L_1 + p_2 L_2 + p_3 L_3; & A &= p_1 L_1^2 + p_2 L_2^2 + p_3 L_3^2 - L^2; \\ B &= L_1 L_2 L_3 - LD; & C &= L_1 + L_2 + L_3 - L; & D &= p_1 L_2 L_3 + p_2 L_1 L_3 + p_3 L_1 L_2. \end{aligned} \quad (6.37)$$

Let us now consider more in detail the evolution map given by Eqs. (6.30) and (6.31). In position representation, one has

$$\varrho(\mathbf{X}, \mathbf{X}', t) = \sum_k p_k e^{-\Gamma^{kk} (1 - \Phi^{kk}(\mathbf{X} - \mathbf{X}')) t} \varrho(\mathbf{X}, \mathbf{X}', 0), \quad (6.38)$$

so that the position density does not vary, i.e. $\varrho(\mathbf{X}, \mathbf{X}, t) = \varrho(\mathbf{X}, \mathbf{X}, 0)$, since $\Phi^{kk}(0) = 1$. By expanding the exponential in Eq. (6.38), we come to

$$\varrho(\mathbf{X}, \mathbf{X}', t) = \sum_k p_k \sum_n \rho_k(n, t) \left(\Phi^{kk}(\mathbf{X} - \mathbf{X}') \right)^n \varrho(\mathbf{X}, \mathbf{X}', 0), \quad (6.39)$$

where

$$\rho_k(n, t) = e^{-\Gamma^{kk} t} \frac{(\Gamma^{kk} t)^n}{n!} \quad (6.40)$$

is the probability that there are n events up to time t , according to a Poissonian renewal process with parameter Γ^{kk} , see Sec. (4.1.2). The characteristic function $\Phi^{kk}(\mathbf{X} - \mathbf{X}')$, see Eq. (6.17),

describes the effect of a single elastic collision event, that involves the internal state labelled by k , on the statistical operator in position representation. For any fixed k , the series over n in Eq. (6.39) associates to the channel k the effects of the n -fold action of the function $\Phi^{kk}(\mathbf{X} - \mathbf{X}')$ on the initial statistical operator, weighted by the corresponding probability of n collisions up to time t , and summed over n . The dynamics is described as a sequence of collisions, randomly distributed in time according to an exponential waiting time distribution, see Sec. (4.2.1). Indeed, the Poissonian distribution of collision events testifies that we are in the presence of semigroup evolutions [193], as far as we take into account a single term $e^{\Lambda_k t}$. The overall dynamics expressed by Eq. (6.39), that is simply given by a convex mixture of the evolutions due to the single channels, can thus be associated with a lack of information about the actual channel involved in the elastic collisions. The function

$$\Psi^k(\mathbf{S}, t) \equiv e^{-\Gamma^{kk}(1-\Phi^{kk}(\mathbf{S}))t} \quad (6.41)$$

is the characteristic function of a compound Poisson process [113, 114]. Unlike the simple Poisson process, such a process is characterized by jump events, here the collisions, with a size that is itself a random variable, here the momentum transfer in a single collision distributed according to $\mathcal{P}^{kk}(\mathbf{Q})$. Therefore, in Eq. (6.39) we have the characteristic function of a convex mixture of compound Poisson processes:

$$\Psi(\mathbf{S}, t) \equiv \sum_k p_k \Psi^k(\mathbf{S}, t) \equiv \sum_k p_k e^{-\Gamma^{kk}(1-\Phi^{kk}(\mathbf{S}))t}. \quad (6.42)$$

6.2 Non-Markovian features in the dynamics of translational degrees of freedom

We have already mentioned that the generalized Lindblad structure typically describes non-Markovian dynamics. Now, we are in the position to explicitly show that this is the case for the reduced dynamics of translational degrees of freedom we are taking into account. A complementary situation has been considered in [199], where the effect of collisional decoherence on internal state superpositions of a cold gas has been studied in detail.

Our starting point consists in the reduced dynamical maps that have been introduced in the previous section to characterize the dynamics of translational degrees of freedom in the absence of initial correlations with internal degrees of freedom. Indeed, this is in accordance with the definitions of non-Markovian dynamics given in Sec. (4.2), that are to be understood as properties of the overall reduced evolution.

6.2.1 Nonexponential visibility reduction

We first consider the loss of visibility in a double-slit arrangement as a function of the time of interaction with the environment, and we illustrate by means of examples how the presence of the various scattering channels can actually lead to behaviors that are significantly different from exponential decays typical of semigroup evolutions [193]. In particular, we will consider the situation of purely elastic collisions in full generality, also allowing for inelastic scattering in the

case of a two-level system. While the experimental setting is always taken to be the same, the different number of internal degrees of freedom involved and the presence or absence of inelastic scattering events will lead to more or less marked non-exponential behaviors in the reduction of the visibility fringes.

Visibility formula

Here, we derive a general formula for the visibility reduction in the case of a double-slit experiment, in the far field approximation. A beam of particles moves towards a grating perpendicular to its direction of propagation, and with two identical slits separated by a distance d , finally reaching a detector where the fringes of interference are observed. During the flight through the interferometer the beam particles interact via collisions with the environment in the background, thus undergoing decoherence. If after the passage through the collimation slits the massive particle is described by ρ_{sl} , then the double-slit grating prepares the initial state [200]

$$\varrho(0) = \frac{2}{C} \cos\left(\frac{\mathbf{P} \cdot \mathbf{d}}{2\hbar}\right) \rho_{\text{sl}} \cos\left(\frac{\mathbf{P} \cdot \mathbf{d}}{2\hbar}\right), \quad (6.43)$$

with $C \equiv \text{Tr}[\cos(\mathbf{P} \cdot \mathbf{d}/(2\hbar)) \rho_{\text{sl}} \cos(\mathbf{P} \cdot \mathbf{d}/(2\hbar))]/2$ normalization constant. Setting, see Eq. (6.25),

$$\varrho(\mathbf{X}, \mathbf{X}, t) = \langle \mathbf{X} | \Lambda(t, 0) [\varrho(0)] | \mathbf{X} \rangle := I(\mathbf{X}), \quad (6.44)$$

we consider the quantity

$$\mathcal{V} = \frac{I_{\text{max}} - I_{\text{min}}}{I_{\text{max}} + I_{\text{min}}}, \quad (6.45)$$

which describes the reduction of the interference pattern with respect to the free case. For the sake of concreteness, let us exploit the time evolution generated by Eq. (6.24). Since it is covariant under translations [193, 35], so that

$$\Lambda(t, 0) [e^{i\mathbf{P} \cdot \mathbf{a}/\hbar} \varrho e^{-i\mathbf{P} \cdot \mathbf{a}/\hbar}] = e^{i\mathbf{P} \cdot \mathbf{a}/\hbar} \Lambda(t, 0) [\varrho] e^{-i\mathbf{P} \cdot \mathbf{a}/\hbar}, \quad (6.46)$$

one has, using Eq. (6.43),

$$\begin{aligned} I(\mathbf{X}) &= \text{Re} \left[\left\langle \mathbf{X} - \frac{1}{2} \mathbf{d} \middle| \Lambda(t, 0) [\rho_{\text{sl}} e^{-i\mathbf{P} \cdot \mathbf{d}/\hbar}] \middle| \mathbf{X} - \frac{1}{2} \mathbf{d} \right\rangle \right] \\ &\quad + \frac{1}{2} \left(\left\langle \mathbf{X} - \frac{1}{2} \mathbf{d} \middle| \Lambda(t, 0) [\rho_{\text{sl}}] \middle| \mathbf{X} - \frac{1}{2} \mathbf{d} \right\rangle + \left\langle \mathbf{X} + \frac{1}{2} \mathbf{d} \middle| \Lambda(t, 0) [\rho_{\text{sl}}] \middle| \mathbf{X} + \frac{1}{2} \mathbf{d} \right\rangle \right), \end{aligned} \quad (6.47)$$

where now t is the time employed by the massive particle to reach the detector. Indeed, this result remains true for any translation-covariant time evolution.

By explicitly substituting the expression in Eq. (6.24), we thus have

$$\begin{aligned} \left\langle \mathbf{X} - \frac{1}{2} \mathbf{d} \middle| \Lambda(t, 0) [\rho_{\text{sl}} e^{-i\mathbf{P} \cdot \mathbf{d}/\hbar}] \middle| \mathbf{X} - \frac{1}{2} \mathbf{d} \right\rangle &= \sum_k p_k \int \frac{d\mathbf{s} d\boldsymbol{\lambda}}{(2\pi\hbar)^3} e^{-i\boldsymbol{\lambda} \cdot \mathbf{s}/\hbar} \\ &\times \left\langle \mathbf{X} - \frac{\mathbf{d}}{2} + \mathbf{s} \middle| \mathcal{U}_0(t) [\rho_{\text{sl}} e^{-i\mathbf{P} \cdot \mathbf{d}/\hbar}] \middle| \mathbf{X} - \frac{\mathbf{d}}{2} + \mathbf{s} \right\rangle e^{-\Gamma^{kk} \int_0^t (1 - \Phi^{kk}(\boldsymbol{\lambda}(t-t')/M)) dt'}, \end{aligned}$$

where $\mathcal{U}_0(t)$ is the free evolution operator of the translational degrees of freedom, see Eq. (6.23), and then

$$\langle \mathbf{X} - \frac{\mathbf{d}}{2} + \mathbf{s} | \mathcal{U}_0(t) [\rho_{\text{sl}} e^{-i\mathbf{P}\cdot\mathbf{d}/\hbar}] | \mathbf{X} - \frac{\mathbf{d}}{2} + \mathbf{s} \rangle = \langle \mathbf{X} - \frac{\mathbf{d}}{2} + \mathbf{s} | \mathcal{U}_0(t) [\rho_{\text{sl}}] | \mathbf{X} + \frac{\mathbf{d}}{2} + \mathbf{s} \rangle. \quad (6.48)$$

The latter expression can also be written

$$\begin{aligned} \langle \mathbf{X} - \frac{\mathbf{d}}{2} | \mathcal{U}_0(t) [\rho_{\text{sl}}] | \mathbf{X} + \frac{\mathbf{d}}{2} \rangle &= \left(\frac{M}{t} \right)^3 e^{-iM\mathbf{d}\cdot\mathbf{X}/(\hbar t)} \int \frac{d\mathbf{Y} d\mathbf{Y}'}{(2\pi\hbar)^3} e^{iM(\mathbf{Y}^2 - \mathbf{Y}'^2)/(2\hbar t)} \\ &\times e^{-iM\mathbf{X}\cdot(\mathbf{Y} - \mathbf{Y}')/(\hbar t)} e^{iM\mathbf{d}\cdot(\mathbf{Y} + \mathbf{Y}')/(2\hbar t)} \langle \mathbf{Y} | \rho_{\text{sl}} | \mathbf{Y}' \rangle, \end{aligned} \quad (6.49)$$

assuming due to symmetry $\text{Tr}(\mathbf{X}\rho_{\text{sl}}) = 0$.

This formula enables us to implement the far field approximation. In fact, let σ be the width of the two slits, so that the integrand is negligible if \mathbf{Y} (and similarly for \mathbf{Y}') takes values outside the support of ρ_{sl} , then $M\mathbf{Y}^2/(\hbar t) \lesssim M\sigma^2/(\hbar t)$ and therefore for a time long enough such that $\hbar t/M \gg \sigma^2$ the first exponential can be disregarded. The same applies for the last exponential if $\hbar t/M \gg \sigma d$. For times longer than $\max\{M\sigma^2/\hbar, M\sigma d/\hbar\}$, corresponding to the far field approximation, we get

$$\langle \mathbf{X} - \frac{\mathbf{d}}{2} | \mathcal{U}_0(t) [\rho_{\text{sl}}] | \mathbf{X} + \frac{\mathbf{d}}{2} \rangle \approx \left(\frac{M}{t} \right)^3 e^{-iM\mathbf{d}\cdot\mathbf{X}/(\hbar t)} \tilde{\rho}_{\text{sl}} \left(\frac{M}{t} \mathbf{X} \right), \quad (6.50)$$

where $\tilde{\rho}_{\text{sl}}(\cdot)$ is the distribution function for the momentum of the particle in the state ρ_{sl} ,

$$\tilde{\rho}_{\text{sl}} \left(\frac{M}{t} \mathbf{X} \right) = \int \frac{d\mathbf{Y} d\mathbf{Y}'}{(2\pi\hbar)^3} e^{-iM\mathbf{X}\cdot(\mathbf{Y} - \mathbf{Y}')/(\hbar t)} \langle \mathbf{Y} | \rho_{\text{sl}} | \mathbf{Y}' \rangle.$$

The equivalence between the assumption $\hbar t/M \gg \sigma^2$ and the far field approximation $L \gg \sigma^2/\lambda$, where $\lambda = \hbar/P_z$ is the wavelength associated with the massive particle and L is the distance between grating and detector, is easily seen from the relation $L = p_z t/M$, where p_z is the component along the z direction of the massive particle, assumed to be constant. Substituting Eq. (6.48) in the first term of Eq. (6.47) and using the approximation $\tilde{\rho}_{\text{sl}}(M(\mathbf{X} + \mathbf{s})/t) \approx \tilde{\rho}_{\text{sl}}(M\mathbf{X}/t)$ valid because of the localization of the state ρ_{sl} , we can easily perform the integrals over \mathbf{s} and $\boldsymbol{\lambda}$, thus finally obtaining

$$\begin{aligned} \text{Re} \left[\langle \mathbf{X} - \frac{1}{2} \mathbf{d} | \Lambda(t, 0) [\rho_{\text{sl}} e^{-i\mathbf{P}\cdot\mathbf{d}/\hbar}] | \mathbf{X} - \frac{1}{2} \mathbf{d} \rangle \right] &\approx \\ \left(\frac{M}{t} \right)^3 \tilde{\rho}_{\text{sl}} \left(\frac{M}{t} \mathbf{X} \right) \text{Re} \left[e^{-iM\mathbf{d}\cdot\mathbf{X}/(\hbar t)} \sum_{k=1}^n p_k e^{-\Gamma^{kk} \int_0^t (1 - \Phi^{kk}(\mathbf{d}' \frac{t'-t}{t})) dt'} \right]. \end{aligned}$$

For the last two terms in Eq. (6.47) one can proceed in an analogous way: using

$$\langle \mathbf{X} \pm \frac{1}{2} \mathbf{d} + \mathbf{s} | \mathcal{U}_0(t) [\rho_{\text{sl}}] | \mathbf{X} \pm \frac{1}{2} \mathbf{d} + \mathbf{s} \rangle \approx \left(\frac{M}{t} \right)^3 \tilde{\rho}_{\text{sl}} \left(\frac{M}{t} \mathbf{X} \right),$$

performing the integral over λ and further observing that $\Phi^{ij}(0) = 1$ for the normalization of $\mathcal{P}^{ij}(\mathbf{Q})$, one gets

$$\langle \mathbf{X} \pm \frac{1}{2} \mathbf{d} | \Lambda(t, 0) | \rho_{\text{sl}} | \mathbf{X} \pm \frac{1}{2} \mathbf{d} \rangle \approx \left(\frac{M}{t} \right)^3 \tilde{\rho}_{\text{sl}} \left(\frac{M}{t} \mathbf{X} \right).$$

Non-exponential behaviors

From the previous expressions, we find that the desired expression for the visibility, see Eq. (6.45), in the absence of inelastic scattering and for an arbitrary number n of channels is given by

$$\mathcal{V} = \left| \sum_{k=1}^n p_k e^{-\Gamma^{kk} \int_0^t (1 - \Phi^{kk}(\mathbf{d} \frac{t'-t}{t})) dt'} \right|, \quad (6.51)$$

where we recall that the probabilities p_k give the weight of the different internal states in the initial preparation. The dependence on t in this formula can be easily made explicit with the change of variable $t'/t = s$, so that one has

$$\mathcal{V} = \left| \sum_{k=1}^n p_k e^{-\Gamma^{kk} (1 - \int_0^1 \Phi^{kk}(\mathbf{d}(s-1)) ds) t} \right|. \quad (6.52)$$

From Eq. (6.52) one can easily see the difference between the Markovian situation, corresponding to $n = 1$, and the general case. If there is just one term in the sum, the modulus simply picks out the real part of the characteristic function in the exponential and Eq. (6.52) describes an exponential decay in time with a rate $\Gamma \left(1 - \int_0^1 \text{Re} \{ \Phi(\mathbf{d}(s-1)) \} ds \right)$. This can happen if only one internal energy state is populated in the initial preparation or the scattering events are actually independent on the internal state. If there are at least two terms, the modulus can generate oscillating terms as a consequence of the interference of the different phases arising since the functions Φ^{kk} are in general complex valued. Even if the imaginary parts of the characteristic functions are zero, i.e. the distribution functions of the exchanged momenta are even, Eq. (6.52) can describe highly non-exponential behavior. In this case, in fact, it reduces to

$$\mathcal{V} = \sum_{k=1}^n p_k e^{-\Gamma^{kk} (1 - \int_0^1 \Phi^{kk}(\mathbf{d}(s-1)) ds) t}, \quad (6.53)$$

i.e. the sum of different exponential functions. As shown in [165] this kind of relations can describe behavior very different from the exponential one.

Let us consider in more detail the case of a two-level system. Introducing the notation

$$\begin{aligned} \alpha^k &:= \text{Re} \int_0^1 \left\{ \Phi^{kk}(\mathbf{d}(s-1)) \right\} ds \\ \beta^k &:= \text{Im} \int_0^1 \left\{ \Phi^{kk}(\mathbf{d}(s-1)) \right\} ds, \end{aligned} \quad (6.54)$$

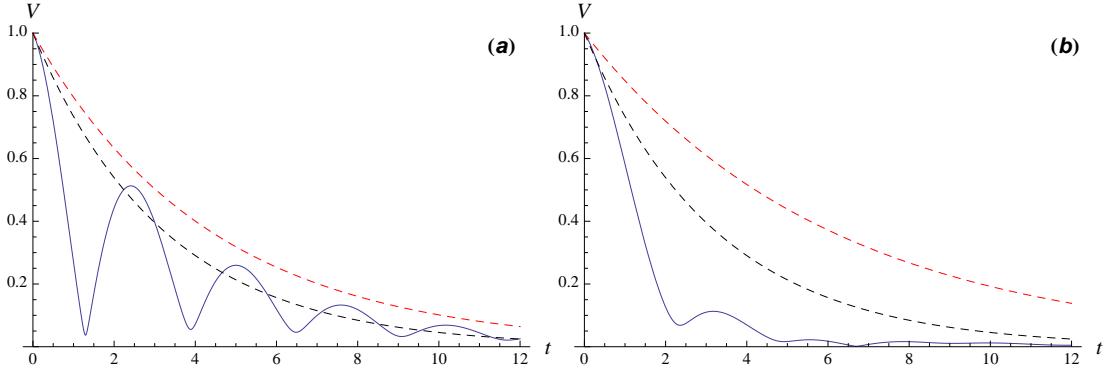

Figure 6.1: Plot of the visibility in a double-slit arrangement as a function of the interaction time with the environment, in arbitrary units, for the case of elastic scattering events only, according to Eq. (6.52) and with growing number of channels from left to right. The dashed lines represent the Markovian exponential decays occurring if a single elastic channel prevails on the others, the one with the highest and lowest decay rate corresponding to lower and upper line respectively. **(a)** Visibility for $n = 2$ elastic channels, according to the expression Eq. (6.55). It appears a non monotonic decay as a consequence of the interference between the contributions of the two different elastic channels. The coefficients α^k and β^k defined in Eq. (6.54) are calculated for two Gaussian distributions $\mathcal{P}^{11}(\mathbf{Q})$ and $\mathcal{P}^{22}(\mathbf{Q})$ of the exchanged momenta. Taking $\mathbf{d} = d\hat{z}$ as direction of propagation inside the interferometer we only need to specify the mean and the variance of the exchanged momenta along this axis, respectively μ_{kk} and σ_{kk} , $k = 1, 2$. The plot is for $p_1 = p_2 = \frac{1}{2}$, while $\Gamma^{11} = \Gamma^{22} = 10$, $d = 1$, $\sigma_{11} = \sigma_{22} = 0.1$, $\mu_{11} = -0.2$, $\mu_{22} = 0.3$ in arbitrary units. **(b)** Visibility for $n = 8$ elastic channels according to the general expression Eq. (6.52). The characteristic functions Φ^{kk} are calculated starting from Gaussian distributions, assuming equal rates $\Gamma^{kk} = 10$ and equal variances $\sigma_{kk} = 0.1$ in arbitrary units as in (a). The p_k are uniformly distributed and the means μ_{kk} are equally spaced in the range from -0.2 to 0.3 .

the visibility reduction is explicitly given by

$$\mathcal{V} = \left[p_1^2 e^{-2\Gamma^{11}(1-\alpha^1)t} + p_2^2 e^{-2\Gamma^{22}(1-\alpha^2)t} + 2p_1 p_2 e^{-\Gamma^{11}(1-\alpha^1)t} e^{-\Gamma^{22}(1-\alpha^2)t} \cos [(\Gamma^{11}\beta^1 - \Gamma^{22}\beta^2)t] \right]^{1/2}. \quad (6.55)$$

This formula describes a decrease modulated by the oscillations produced by the cosine function. To illustrate this behavior, in Fig. (6.1.a) we plot the visibility as a function of time, considering by means of example two Gaussian distributions. Note that the appearance of the oscillations depends on a non vanishing mean value for the distribution functions $\mathcal{P}^{kk}(\mathbf{Q})$ given by Eq. (6.8), which describe the state dependent momentum transfers. This feature corresponds to a preferred direction in the net momentum transfer between massive particle and environment, as happens e.g. by the interaction with a laser beam [201], the asymmetry in the single interaction channel being determined in this case by the direction of propagation.

The behavior described by Eq. (6.52) for an n -level system is illustrated in Fig. (6.1.b), where we show how the increased number of levels can strongly suppress the oscillations and lead to

a reduction of the visibility. The dashed lines represent the exponential decays pertaining to the semigroup evolution arising if only one of the internal energy states is initially populated, the one with the highest or lowest decoherence rate corresponding to the lower or upper dashed line, respectively. It appears that with growing n the interference between the contributions of the different channels to Eq. (6.52) rapidly determines a decay of the visibility sensibly faster than that occurring for the corresponding Markovian single-channel dynamics. Indeed in Fig. 6.1 left and right panel correspond to the same interaction strength but differ in the number of involved degrees of freedom, ranging to $n = 2$ to $n = 8$.

Relying on the results of Sec.(6.1.3), one can also obtain an expression of the visibility in the presence of inelastic scattering for a two-level system. Indeed starting from Eq. (6.29) and following the same procedure as above one comes to

$$\begin{aligned} \mathcal{V} = & \left| e^{-\Gamma^{12}t} + \Gamma^{12} e^{-\Gamma^{11}t} \int_0^1 (1 - \Phi^{11}(d(s-1)) ds \right. \\ & \left. \times \int_0^t \left(e^{-\Gamma^{12}t'} e^{+\Gamma^{11} \int_0^{t'} (1 - \Phi^{11}(d(t''-t)/t)) dt''} \Phi^{12} \left(\frac{d^{t'} - t}{t} \right) \right) dt' \right|, \end{aligned} \quad (6.56)$$

where for simplicity we have taken $p_2 = 1$ and $\Gamma^{22} = 0$, so that the oscillations in the visibility cannot be traced back to interference among different components. An illustration of the behavior of the visibility in this case has been plotted in Fig. (6.2), always assuming for the sake of generality a Gaussian distribution of momentum transfers. In this case the dashed line corresponds to the exponential Markovian decay occurring if only the elastic channel is involved in the dynamics. It immediately appears that a non monotonic behavior in the loss of visibility is observed also in this case, due to the multiple time integration in Eq. (6.29).

6.2.2 Back flow of information

In this paragraph, we want to define in a more precise way the non-Markovian nature of the dynamics of the translational degrees of freedom, as determined by the generalized Lindblad structure in Eq. (6.7). For this purpose, we employ the idea of back flow of information introduced in Sec. (4.2) and Appendix E. We deal with the dynamics of the translational degrees of freedom described by Eq. (6.30), i.e., we neglect the Hamiltonian term in the evolution and we take into account elastic collisions only. This allows us to explicitly present non-monotonic evolutions of trace distance, that are further directly connected to the behaviors of visibility described in the previous paragraph.

As explained in Sec. 4.2 and in Appendix E, a criterion to assess the non-Markovianity of a given dynamics is provided by a non-monotonic behavior of the trace distance between two states of the open system under investigation, evolved from different initial states. In order to properly select a couple of initial states $\varrho^1(0)$ and $\varrho^2(0)$, we come back to the double-slit arrangement presented in Sec. (6.2.1). Let us describe the state of the massive particle after the passage through the collimation slits as a Gaussian wave packet with mean value of the position \mathbf{X}^0 , mean value of the momentum \mathbf{P}^0 and variance σ^2 , i.e. $\rho_{sl} = |\psi_{\mathbf{X}^0, \mathbf{P}^0, \sigma}\rangle \langle \psi_{\mathbf{X}^0, \mathbf{P}^0, \sigma}|$, where we introduced the notation

$$\langle \mathbf{X} | \psi_{\mathbf{x}, \mathbf{p}, \sigma} \rangle := \frac{1}{\sqrt[4]{2\pi\sigma^2}} e^{-\frac{(\mathbf{X}-\mathbf{x})^2}{4\sigma^2} + \frac{i}{\hbar} \mathbf{p} \cdot (\mathbf{X}-\mathbf{x})}. \quad (6.57)$$

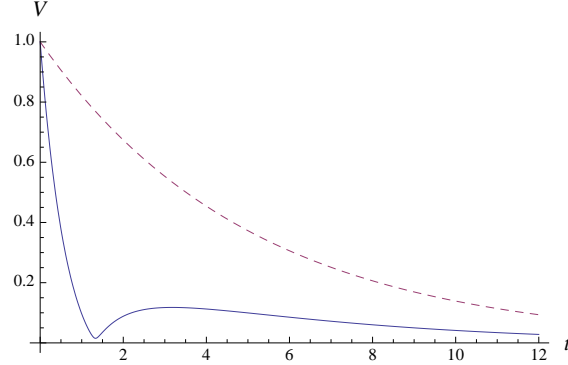

Figure 6.2: Plot of the visibility in a double-slit arrangement as a function of the interaction time with the environment, in arbitrary units, for the case in which one of the internal states also undergoes inelastic scattering, according to Eq. (6.56) with $n = 2$. It clearly appears a non monotonic decay of the visibility as a consequence of the multiple time integration describing the contribution of the inelastic channel. The distributions of momentum transfers are assumed Gaussian, with $\sigma_{11} = 1, \sigma_{12} = 3, \mu_{11} = 1, \mu_{12} = 5$; moreover $\Gamma^{11} = 0.75$ and $\Gamma^{12} = 1.75$, in arbitrary units. The dashed line corresponds to the Markovian dynamics determined by the channel undergoing elastic scattering only.

The momentum \mathbf{P}^0 represents the initial momentum of the massive particle entering the interferometer. Then, the double-slit grating prepares the state

$$|\psi\rangle = \frac{\sqrt{2}}{\sqrt{C}} \cos\left(\frac{\mathbf{P} \cdot \mathbf{d}}{2\hbar}\right) |\psi_{\text{sl}}\rangle = \frac{1}{\sqrt{2C}} (|\psi_{\mathbf{X}^0 + \mathbf{d}/2, \mathbf{P}^0, \sigma}\rangle + |\psi_{\mathbf{X}^0 - \mathbf{d}/2, \mathbf{P}^0, \sigma}\rangle), \quad (6.58)$$

that is a superposition of two Gaussian wave packets with equal variance σ^2 and mean momentum \mathbf{P}^0 , and centered, respectively, in $\mathbf{X}^0 + \mathbf{d}/2$ and $\mathbf{X}^0 - \mathbf{d}/2$. The normalization constant C is given by

$$C = \frac{1}{\sqrt{2\pi\sigma^2}} \int d\mathbf{X} e^{-\frac{(\mathbf{x} - \mathbf{x}^0 + \mathbf{d}/2)^2}{4\sigma^2}} e^{-\frac{(\mathbf{x} - \mathbf{x}^0 - \mathbf{d}/2)^2}{4\sigma^2}} = e^{-\frac{|\mathbf{d}|^2}{8\sigma^2}}. \quad (6.59)$$

The pure state in Eq. (6.57) is the first initial state we take into account to analyze the evolution of trace distance, i.e.

$$\varrho^1(0) = |\psi\rangle\langle\psi|. \quad (6.60)$$

As second initial state, consider the convex mixture of the same two Gaussian states, according to

$$\varrho^2(0) = \frac{1}{2} (|\psi_{\mathbf{X}^0 + \mathbf{d}/2, \mathbf{P}^0, \sigma}\rangle\langle\psi_{\mathbf{X}^0 + \mathbf{d}/2, \mathbf{P}^0, \sigma}| + |\psi_{\mathbf{X}^0 - \mathbf{d}/2, \mathbf{P}^0, \sigma}\rangle\langle\psi_{\mathbf{X}^0 - \mathbf{d}/2, \mathbf{P}^0, \sigma}|). \quad (6.61)$$

This corresponds to a statistical mixture, with equal weights, of the two preparation procedures performed by opening the two slits in the grating one at a time.

Given two initial reduced states $\varrho^1(0)$ and $\varrho^2(0)$, the difference between the corresponding states

at time t evolved according to Eq. (6.30) is fixed by the relation, see Eq. (6.38),

$$\varrho^1(\mathbf{X}, \mathbf{X}', t) - \varrho^2(\mathbf{X}, \mathbf{X}', t) = \sum_k p_k e^{-\Gamma^{kk}(1-\Phi^{kk}(\mathbf{X}-\mathbf{X}'))t} (\varrho^1(\mathbf{X}, \mathbf{X}', 0) - \varrho^2(\mathbf{X}, \mathbf{X}', 0)). \quad (6.62)$$

Now, let us consider in more details the two terms $\varrho^1(\mathbf{X}, \mathbf{X}', 0)$ and $\varrho^2(\mathbf{X}, \mathbf{X}', 0)$ in the previous relation. For the states in Eqs. (6.60) and (6.61), we have

$$\begin{aligned} \varrho^1(\mathbf{X}, \mathbf{X}', 0) &= \frac{e^{i\mathbf{P}^0 \cdot (\mathbf{X}-\mathbf{X}')/\hbar}}{2C\sqrt{2\pi\sigma^2}} \left(e^{-\frac{(\mathbf{X}-\mathbf{X}^0-d/2)^2}{4\sigma^2}} e^{-\frac{(\mathbf{X}'-\mathbf{X}^0-d/2)^2}{4\sigma^2}} + e^{-\frac{(\mathbf{X}-\mathbf{X}^0+d/2)^2}{4\sigma^2}} e^{-\frac{(\mathbf{X}'-\mathbf{X}^0+d/2)^2}{4\sigma^2}} \right. \\ &\quad \left. + e^{-i\frac{\mathbf{P}^0 \cdot \mathbf{d}}{\hbar}} e^{-\frac{(\mathbf{X}-\mathbf{X}^0-d/2)^2}{4\sigma^2}} e^{-\frac{(\mathbf{X}'-\mathbf{X}^0+d/2)^2}{4\sigma^2}} + e^{i\frac{\mathbf{P}^0 \cdot \mathbf{d}}{\hbar}} e^{-\frac{(\mathbf{X}-\mathbf{X}^0+d/2)^2}{4\sigma^2}} e^{-\frac{(\mathbf{X}'-\mathbf{X}^0-d/2)^2}{4\sigma^2}} \right) \\ \varrho^2(\mathbf{X}, \mathbf{X}', 0) &= \frac{e^{i\mathbf{P}^0 \cdot (\mathbf{X}-\mathbf{X}')/\hbar}}{2\sqrt{2\pi\sigma^2}} \left(e^{-\frac{(\mathbf{X}-\mathbf{X}^0-d/2)^2}{4\sigma^2}} e^{-\frac{(\mathbf{X}'-\mathbf{X}^0-d/2)^2}{4\sigma^2}} + e^{-\frac{(\mathbf{X}-\mathbf{X}^0+d/2)^2}{4\sigma^2}} e^{-\frac{(\mathbf{X}'-\mathbf{X}^0+d/2)^2}{4\sigma^2}} \right) \end{aligned} \quad (6.63)$$

Assuming that $|\mathbf{d}|/\sigma \gg 1$, then $C \approx 1$ and the difference $\rho_1(\mathbf{X}, \mathbf{X}', 0) - \rho_2(\mathbf{X}, \mathbf{X}', 0)$ can be well approximated by the last two terms in the sum giving $\varrho^1(\mathbf{X}, \mathbf{X}', 0)$ in Eq. (6.63). Thus, if we further assume that the characteristic functions $\Phi^{kk}(\mathbf{S})$ are slowly varying on the spatial scale fixed by σ , Eq. (6.62) gives

$$\varrho^1(t) - \varrho^2(t) \approx \sum_k p_k e^{-\Gamma^{kk}(1-\Phi^k(\mathbf{d}))t} (\varrho^1(0) - \varrho^2(0)), \quad (6.64)$$

where we set $\Phi^{kk}(\mathbf{X} - \mathbf{X}') \approx \Phi^k(\mathbf{d})$ for $|\mathbf{X} - \mathbf{X}'|$ within a proper interval centered on \mathbf{d} and with a width fixed by σ . Thus, the evolution of the trace distance is simply given by

$$D(\varrho^1(t), \varrho^2(t)) \approx \left| \sum_k p_k e^{-\Gamma^{kk}(1-\Phi^k(\mathbf{d}))t} \right| D(\varrho^1(0), \varrho^2(0)). \quad (6.65)$$

By comparing Eq. (6.65) with Eq. (6.51), one can immediately see how, under the specific approximations considered here and in the previous paragraph, trace distance can reproduce the behavior in time of visibility. In the presence of a single non zero term $p_k = 1$, it is found that the trace distance exponentially decays. Indeed, we are here in the case of a semigroup evolution, so that there is no back flow of information from the environment to the translational degrees of freedom, see Appendix (E). On the other hand, if there are more terms, one can observe trace-distance oscillations due to the interference of the different phases of the complex-valued functions Φ^k . To be explicit, for $n = 2$, we have, in full analogy with Eq. (6.55),

$$\begin{aligned} D(\varrho^1(t), \varrho^2(t)) &= \left[p_1^2 e^{-2\Gamma^{11}(1-\text{Re}[\Phi^1(\mathbf{d}))t} + p_2^2 e^{-2\Gamma^{22}(1-\text{Re}[\Phi^2(\mathbf{d}))t} + 2p_1 p_2 e^{-\Gamma^{11}(1-\text{Re}[\Phi^1(\mathbf{d}))t} \right. \\ &\quad \left. \times e^{-\Gamma^{22}(1-\text{Re}[\Phi^2(\mathbf{d}))t} \cos [(\Gamma^{11} \text{Im}[\Phi^1(\mathbf{d})) - \Gamma^{22} \text{Im}[\Phi^2(\mathbf{d}))t]] \right]^{1/2} D(\varrho^1(0), \varrho^2(0)). \end{aligned} \quad (6.66)$$

Thus, the plot in Fig. (6.1.a) also reproduces, for proper $\Phi^1(\mathbf{d})$ and $\Phi^2(\mathbf{d})$, the dynamics of the trace distance for the two above-mentioned initial states. Indeed, a completely analogous conclusion about Fig. (6.1.b) can be drawn for $n = 8$. This analysis justifies, for the case at hand, the fact

that non-monotonic behavior of the visibility are associated with a non-Markovian dynamics of the system under investigation. According to Eq. (E.3), by integrating the derivative of the function that multiplies $D(\varrho^1(0), \varrho^2(0))$ in Eq. (6.66) over the temporal regions where it is positive, we would get a lower bound to the non-Markovianity measure based on trace distance. In fact, we are here considering only specific couples of initial states, for which the approximations leading to Eq. (6.66) hold. The complete determination of such a measure would require an evaluation of the trace-distance evolution for all the possible couples of initial states, in order to perform the maximization procedure in Eq. (E.3). This topic goes beyond the scope of this work, the difficulty relying on the infinite dimension of the Hilbert space we are dealing with. On the one hand, this implies that the maximization procedure in the definition of the non-Markovianity measure requires to take into account an infinite set of parameters. On the other hand, there is no way to calculate, analytically as well as numerically, the trace distance between a generic couple of statistical operators of an infinite dimensional system, except for specific classes of initial states. An analysis for Gaussian states evolving through dynamics that preserve the Gaussian nature of the states has been performed in [202].

Coming back to the considerations expressed at the beginning of Sec. (6.1.2), we can now give a clear physical interpretation to the appearance of non-Markovian effects, in terms of information flow. If the open system under investigation consists of the whole massive particle that interacts with a low density background gas via the Lindblad equation in Eq. (6.1), any possibility of a back flow of information from the environment to the open system is excluded. But, by changing the border between the open system and the environment, we are now including into the latter a part of the total system that is able to give back some information previously flowed into it to the remaining part of the open system.

Chapter 7

Conclusions

In this Thesis two leading topics of the theory of open quantum systems have been explored. Namely, we have investigated the concept of non-Markovianity as well as the role of initial system-environment correlations in the dynamics of open quantum systems.

As a first step, we have described the dynamics of open quantum systems by means of a one-parameter family of completely positive trace preserving linear maps on the state space of the open system. In particular, we have given different representations of these maps, thus presenting in a compact and unified way several techniques that are regularly used in the theory of open quantum systems and that have been employed throughout the entire Thesis. By means of these techniques, we have shown the general connections between quantum dynamical maps and local as well as non-local in time master equations. Apart from possible isolated singularities, a generic dynamics of an open quantum system can be equivalently described by both time-local and integrodifferential master equations. Moreover, the requests of trace and hermiticity preservation impose some general constraints on the operator structure of such equations of motion. This general analysis has then been applied to the physical model consisting of a two-level atom interacting with the radiation field through a Jaynes-Cummings Hamiltonian.

The relation between the concepts of non-Markovian quantum dynamics and classical non-Markovian stochastic process has been one of the main focuses of this Thesis. In particular, we have taken into account two recently introduced criteria for a quantum dynamics to be non-Markovian. The first criterion relies on the use of trace distance, that quantifies the distinguishability between quantum states. Any variation of the trace distance between reduced states can be associated with an information flow between the open system and the environment. Non-Markovian quantum dynamics are then characterized by a non-monotonic behavior of trace distance, indicating back-flow of information from the environment to the open system. A different and non-equivalent criterion identifies the non-Markovianity of quantum dynamics with the violation of a divisibility property of the corresponding family of dynamical maps. We have seen how both these criteria of non-Markovianity for quantum dynamics naturally induce analogous criteria on the classical setting. These concern the one-point probability distribution of stochastic processes and, as a consequence, they are by no means equivalent to the definition of classical non-Markovian stochastic process that involves the entire hierarchy of n -point conditional probability distributions. In par-

ticular, the correspondence between conditional probabilities and transition maps, that is proper to Markov processes and that is at the basis of the identification between Markovianity and the above-mentioned divisibility property, does no longer hold in non-Markov processes, as we have explicitly shown through a class of semi-Markov processes. Both the introduced criteria are sufficient, but not necessary conditions in order to assess the non-Markovianity of a classical process in its precise meaning. In this respect, one should distinguish between the non-Markovianity of stochastic processes and that of dynamical evolutions, being classical or quantum. Moreover, the two criteria of non-Markovianity lead to the introduction of quantities that measure the degree of non-Markovian behavior in open-system dynamics. We have given an exact evaluation of such quantities for a significant class of quantum dynamics, thus obtaining an explicit comparison between them. In particular, we have demonstrated that the measure based on divisibility gives the same infinite value to quite different time evolutions, at variance with the measure based on the dynamics of trace distance, which assigns them different weights.

From the analysis performed in this work, it seems quite natural that the non-Markovianity of a dynamics cannot be quantified by a single indicator. Indeed, several quantities could be useful, each capturing a different aspect related to non-Markovian dynamics. Here, we have focused on the maximal deviation from the monotonic decrease of trace distance, obtained for a proper couple of initial states. Different procedures, also based on the evolution of the distinguishability between reduced states, could rely on taking the average behavior with the varying of the couples of initial states, or on restricting the analysis to a suitable set of initial states. For example, in [202] the class of Gaussian states is taken into account and the concept of Gaussian degree of non-Markovianity is introduced. Note that this could represent a useful starting point for an explicit quantitative evaluation of non-Markovianity in infinite dimensional quantum systems, as that considered in Chapter 6.

The approach to the dynamics of open quantum systems based on trace distance has shown to be very useful also in dealing with the issue of initial-system environment correlations. In fact, also in this case, it allows to quantitatively describe the reduced dynamics by simply requiring the knowledge of observables of the open system. We have reported the first experimental observation of the influence of initial correlations between an open quantum system and its environment by means of trace distance. In particular, we have shown the increase of the distinguishability between two reduced states, sharing the same environmental state, over its initial value on both short- and long-time scales. We have employed an all-optical setting, in which the use of a spatial light modulator has allowed us to introduce initial correlations in a very general way. Furthermore, the analysis performed by means of trace distance supplies general connections between structural features of the initial total state and relevant aspects of the subsequent dynamics, as we have shown by considering the paradigmatic and exactly solvable model provided by the Jaynes-Cummings Hamiltonian. More precisely, the total amount of correlations of the thermal state is reflected into the amount of information that is initially inaccessible for the open system and that is uncovered during its subsequent time evolution, as quantified by the temporal maximum of the trace distance.

Finally, we have taken into account the dynamics of a massive particle with translational and internal degrees of freedom interacting through collisions with a low density gas. Apart from the introduction of a reference model for collisional decoherence, this allowed us to elucidate how the

presence of both initial correlations and non-Markovian behaviors in an open-system dynamics ultimately depends on where the border between system and environment is placed. Furthermore, in a specific case for the model at hand, we have explicitly shown the strict relationship between the evolution of trace distance and interferometric visibility. Both exhibit strongly non-monotonic evolutions, as a signature of non-Markovian dynamics.

Outlook

Several and interesting questions arise when moving from the field of quantum Markovian dynamics to that of quantum non-Markovian dynamics. We have seen how some of them can be actually faced, by means of the detection of proper classes of quantum non-Markovian dynamics as well as the introduction of general strategies in order to assess the non-Markovian features of open system dynamics. In particular, the approach based on trace distance, in addition to its clear and direct physical meaning, also provides a general characterization of the dynamics in the presence of initial system-environment correlations. Nevertheless, many important issues are still unsolved. In the following, we report those we plan to deal with in our future research.

To our understanding, the basic topic that still has to be fully clarified is the connection between non-Markovianity and correlations in the dynamics of open quantum systems. A physical picture often behind a Markovian description of the dynamics is that the correlations between the open system and the environment created by their interaction up to a generic time t do not have a significant influence on the subsequent dynamics of the open system, so that the total state can be effectively described by means of a product state, at any time t . Indeed, the use of trace distance could help to formulate and check such a picture in a more precise way. In fact, a non-monotonic behavior of the trace distance in a non-Markovian dynamics can be read as an increase of distinguishability with respect to its value at a shifted initial time, which indicates the presence and effectiveness of system-environment correlations.

Another important open problem is the fact that, given a generic master equation, one is not able to determine whether this guarantees a well-defined time evolution, in particular preserving positivity. As we have shown with a simple example, it is not even possible to safely add different contributions that individually would lead to well-defined evolutions. This is of relevance especially in relation with a phenomenological description of open-system dynamics, in which one would need for general rules in order to properly introduce master equations, also on the basis of physical intuition.

The approach to the dynamics of open quantum systems based on the analysis of information flow between the open system and the environment can be further investigated in different directions. It is clear that an important freedom is still left in the choice of the distance measure used to quantify the distinguishability of quantum states. Not any metric could be employed, since a necessary condition is that completely positive trace preserving maps must be contractions for the metric, which is not satisfied, e.g., for the apparently natural Hilbert-Schmidt distance [203]. Nevertheless, there are possible candidates besides the trace distance, such as regularized versions of relative entropy [204], the Bures metric, that is based on fidelity, or the Hellinger distance [205]. A basic question is whether these different distance measures would lead to a growth of trace distance within the same time intervals. This fact would be of relevance for the study of both initial correlations and

measure for non-Markovianity. Indeed, while a different quantitative behavior of the various distances would simply set a different scale in measuring non-Markovianity, it is quite important to clarify whether different measure would provide distinct characterizations of non-Markovianity. We will address this issue by studying how the different metrics affect the evolution of distinguishability as well as the inequalities for the case of initial correlations.

Finally, a crucial aspect of quantum mechanics is that quantum states have different types of correlations. The influence of these different kinds of correlations on the evolution of trace distance is meant to be investigated, looking for possible distinct signatures. On the one hand, this would be of relevance in identifying the different correlations in the initial total state. On the other hand, this would clarify the role played by the classical or quantum nature of initial correlations in the subsequent dynamics of the open system. Furthermore, we want to expand the experimental investigation of the effects of initial system-environment correlations by means of trace distance. Indeed, an important goal will be to provide concrete strategies in order to experimentally identify the different kinds of correlations which are present in the initial total state, by studying the evolution of trace distance.

Appendix A

Quantum measurement

In this appendix, we want to briefly recall how the transformation of a quantum system due to a measurement process is described within the statistical formulation of quantum mechanics. For a more exhaustive treatment see, e.g., [1].

The mathematical representative characterizing a state transformation as a consequence of a given measurement is usually called *instrument*. Let Ω be the set of the possible outcomes of a measurement performed on a given observable and let $\mathfrak{A}(\Omega)$ be a σ -algebra over Ω . An instrument \mathcal{F} is a map associating to each element $M \in \mathfrak{A}(\Omega)$, a linear operator $\mathcal{F}(M)$ on trace class operators, called *operation*, i.e.,

$$\begin{aligned}\mathcal{F}(\cdot) : \mathfrak{A}(\Omega) &\rightarrow \mathcal{L}(\mathcal{TC}(\mathcal{H})) \\ M &\rightarrow \mathcal{F}(M),\end{aligned}$$

in a way such that

$$\mathrm{Tr} \{ \mathcal{F}(\Omega) [\rho] \} = \mathrm{Tr} \rho \quad (\text{A.1})$$

$$\mathcal{F}(\cup_i M_i) = \sum_i \mathcal{F}(M_i) \quad \text{if } M_i \cap M_j = \emptyset \text{ for } i \neq j \quad (\text{A.2})$$

and such that for any $M \in \mathfrak{A}(\Omega)$ the map $\mathcal{F}(M)$ is completely positive and trace decreasing, i.e. $\mathrm{Tr} \{ \mathcal{F}(M) [\rho] \} \leq \mathrm{Tr} \rho$ for any $M \in \mathfrak{A}(\Omega)$ and $\rho \in \mathcal{T}(\mathcal{H})$.

Let us now call ρ the statistical operator describing an ensemble of physical systems prepared according to a certain preparation procedure. If a measurement process is performed on such an ensemble, but no selection is made on the basis of a definite outcome¹, one speaks about a *non-selective* measurement. This maps the initial state of the system ρ into the state, so-called *a-priori*,

$$\rho' = \mathcal{F}(\Omega) [\rho]. \quad (\text{A.3})$$

¹This situation is often described by saying that the outcome of the measurement is not *known*. But, according to the formulation of quantum mechanics we are adopting here, it is not the mere knowledge of the outcome of a measurement that modifies the state of the system, but, instead, the *selection* over the ensemble that is performed on the basis of such knowledge.

Note that even if no selection has been made, the state of the system has changed, as a consequence of the interaction with the measurement apparatus. On the other hand, if one selects the elements of the ensemble that have given an outcome within the set $M \in \mathfrak{A}(\Omega)$, the measurement process, in this case called *selective*, maps the state ρ into the *a-posteriori* state

$$\rho'(M) = \frac{\mathcal{F}(M)[\rho]}{\text{Tr}\{\mathcal{F}(M)[\rho]\}}. \quad (\text{A.4})$$

By means of instruments, one can also describe the statistic associated with a measurement process. In fact, the probability that the outcome of a measurement is within the set $M \in \mathfrak{A}(\Omega)$ can be expressed by the relation

$$\mu_\rho^{\mathcal{F}}(M) = \text{Tr}\{\mathcal{F}(M)[\rho]\}. \quad (\text{A.5})$$

From Eq. (2.18) it is then clear that every instrument \mathcal{F} fixes a POVM F , since any effect $F(M)$ can be defined through

$$F(M) = \mathcal{F}^*(M)[\mathbb{1}], \quad (\text{A.6})$$

where $\mathcal{F}^*(M)$ denotes the dual map to $\mathcal{F}(M)$, see Sec. (2.2.1), so that it holds

$$\text{Tr}\{\mathcal{F}(M)[\rho]\} = \text{Tr}\{\mathbb{1}(\mathcal{F}(M)[\rho])\} = \text{Tr}\{(\mathcal{F}^*(M)[\mathbb{1}])[\rho]\} = \text{Tr}\{F(M)\rho\}. \quad (\text{A.7})$$

It is important to note that the correspondence between instruments and POVMs is not one-to-one. Indeed, there are different macroscopic devices that can modify the state of the system in non-equivalent ways, but that do provide a measurement of the same observable. This reflects into the fact that, in general, an infinite number of different instruments can lead to the same POVM through Eq. (A.7). In this sense, a POVM is the mathematical representative of an equivalence class of registration procedures. Moreover, Eq. (A.5) allows to explain the connection between a-priori and a-posteriori states of a measurement process. Consider for simplicity an observable with values m in a discrete set Ω . Then, Eqs. (A.2)-(A.5) give

$$\rho' = \sum_{m \in \Omega} \mathcal{F}_m[\rho] = \sum_{m \in \Omega} \mu_\rho^{\mathcal{F}}(m) \rho'_m, \quad (\text{A.8})$$

that is the a-priori state is a statistical mixture of the possible a-posteriori states corresponding to the different outcomes m .

Any operation is a linear map on trace class operators and, as such, it can be described by means of the techniques introduced in Sec. (2.2), in the case of a finite-dimensional Hilbert space. Furthermore, operations are by definition completely positive, and then the Kraus decomposition applies. In particular, taking for simplicity an observable with a discrete set of possible outcomes and referred to a finite dimensional Hilbert space, the Kraus decomposition yields an explicit representation of the operation $\mathcal{F}(M)$, as

$$\mathcal{F}(M)[\rho] = \sum_{m \in M} \sum_{\lambda_m} \Xi_{\lambda_m} \rho \Xi_{\lambda_m}^\dagger, \quad (\text{A.9})$$

with Ξ_{λ_m} linear operators on \mathcal{H} . Then Eq. (A.1) implies

$$\sum_{m \in \Omega} \sum_{\lambda_m} \Xi_{\lambda_m}^\dagger \Xi_{\lambda_m} = \mathbb{1}. \quad (\text{A.10})$$

The operation defined in Eq. (A.9) is associated through Eq. (A.7) with the effect

$$F(M) = \sum_{m \in M} \sum_{\lambda_m} \Xi_{\lambda_m}^\dagger \Xi_{\lambda_m}. \quad (\text{A.11})$$

Finally, if the instrument \mathcal{F} is associated with a PVM, see Sec. (2.1.2), related by the spectral theorem to a self-adjoint operator with a discrete non-degenerate spectrum, the non-selective measurement is given by the usual formula

$$\mathcal{F}(\Omega) [\rho] = \sum_{m \in \Omega} \Pi_m \rho \Pi_m, \quad (\text{A.12})$$

with Π_m projector into the unidimensional eigenspace of the eigenvalue m .

Appendix B

One-parameter semigroups

A one-parameter family of bounded linear maps $\{\Lambda_t\}_{t \geq 0}$ on a Banach space X , with norm $\|\cdot\|_X$, is said to be a *one-parameter semigroup* if [206, 207, 208]

$$\begin{aligned}\Lambda_0 &= \mathbb{1} \\ \Lambda_t \Lambda_s &= \Lambda_{t+s} \quad \forall t, s \geq 0.\end{aligned}\tag{B.1}$$

A one-parameter semigroup is *strongly continuous* if

$$\lim_{t \rightarrow 0^+} \|\Lambda_t x - x\|_X \rightarrow 0 \quad \forall x \in X,\tag{B.2}$$

that is if the map $t \mapsto \Lambda_t$ is continuous with respect to the strong operator topology. Given a strongly continuous semigroup, one can define the (infinitesimal) *generator* A through the relation

$$\lim_{t \rightarrow 0^+} \left\| \frac{\Lambda_t x - x}{t} - Ax \right\|_X = 0 \quad \text{for } x \in \text{dom } A.\tag{B.3}$$

The domain of the generator A , $\text{dom } A$, is dense in X and A is a closed operator, i.e. if $x_n \in \text{dom } A$ and $\lim_{n \rightarrow \infty} \|x_n - x\|_X = \lim_{n \rightarrow \infty} \|Ax_n - y\|_X = 0$, then $x \in \text{dom } A$ and $Ax = y$. Moreover, one has

$$\frac{d}{dt} \Lambda_t x = \Lambda_t Ax = A \Lambda_t x \quad \forall x \in \text{dom } A,\tag{B.4}$$

that is

$$Ax = \left. \frac{d}{dt} \Lambda_t x \right|_{t=0} \quad \forall x \in \text{dom } A.\tag{B.5}$$

A *contraction semigroup* is a strongly continuous one-parameter semigroup such that

$$\|\Lambda_t x\|_X \leq \|x\|_X \quad \forall t \geq 0.\tag{B.6}$$

A central result of the theory of strongly continuous semigroup is given by the Hille-Yosida theorem [209, 210], that for contraction semigroups reads:

Theorem (Hille-Yosida) A linear operator A is the generator of a contraction semigroup if and only if

1. $\text{dom}A$ is dense in X
2. for every $y \in X$ and $\lambda > 0$, the equation $\lambda x - Ax = y$ has a unique solution $x \in \text{dom} A$
3. $\|\lambda x - Ax\|_X \geq \lambda \|x\|_X$ for any $x \in \text{dom} A$ and $\lambda \geq 0$.

Contraction semigroups are relevant for the theoretical study of the dynamics of open quantum systems since a one-parameter strongly continuous semigroup $\{\Lambda_t\}_{t \geq 0}$ on the set $\mathcal{T}(\mathcal{H})$ of trace class operators such that

$$\text{Tr}[\Lambda_t \sigma] = \text{Tr}[\sigma] \quad \forall \sigma \in \mathcal{T}(\mathcal{H}) \quad (\text{B.7})$$

$$\Lambda_t \sigma \geq 0 \quad \forall \sigma \geq 0 \in \mathcal{T}(\mathcal{H}) \quad (\text{B.8})$$

is a contraction semigroup [14, 211]. In particular, it holds the following theorem [212]:

Theorem (Kossakowski) A bounded linear map A on $\mathcal{T}(\mathcal{H})$ generates a semigroup satisfying Eqs. (B.7) and (B.8) if and only if for every discrete resolution of the identity $\mathbb{P} = (P_1, P_2, \dots)$ it holds

$$\begin{aligned} a_{ii}(\mathbb{P}) &\leq 0 \quad i = 1, 2, \dots \\ a_{ij}(\mathbb{P}) &\geq 0 \quad i \neq j = 1, 2, \dots \\ \sum_{i=1}^{\infty} a_{ij}(\mathbb{P}) &= 0 \quad j = 1, 2, \dots \end{aligned} \quad (\text{B.9})$$

where

$$a_{ij}(\mathbb{P}) = \text{Tr}[P_i A P_j] \quad (\text{B.10})$$

and we recall that a discrete resolution of the identity on a Hilbert space \mathcal{H} is a sequence $\mathbb{P} = (P_1, P_2, \dots)$ of projection operators such that $P_i P_j = \delta_{ij} P_i$, $\text{Tr}[P_i] < \infty$ for $i, j = 1, 2, \dots$ and $\sum_i P_i = \mathbb{1}$.

This theorem allows to fully characterize the explicit structure of the generators of one-parameter semigroups of *completely positive* trace preserving linear maps on finite dimensional Hilbert space, see Sec. (3.3.1).

Finally, a one-parameter semigroup is norm (or uniformly) continuous if the map $t \mapsto \Lambda_t$ is continuous in the norm (or uniform) operator topology, that is $\lim_{t \rightarrow 0^+} \|\Lambda_t - \mathbb{1}\|_{\infty} = 0$. A linear operator A is the generator of a norm continuous semigroup if and only if A is a bounded linear operator and any norm continuous semigroup can be written as

$$\Lambda_t = e^{At} = \sum_k \frac{t^k A^k}{k!}. \quad (\text{B.11})$$

Note that the domain of the generator A of a strongly continuous one-parameter semigroup is the whole Banach space X if and only if A is bounded, that is if and only if the semigroup is norm continuous.

Appendix C

Trace distance

The trace distance between two trace class operators σ and ω is defined as $\frac{1}{2}$ times the trace norm of $\sigma - \omega$,

$$D(\sigma, \omega) = \frac{1}{2} \|\sigma - \omega\|_1, \quad (\text{C.1})$$

where the trace norm of an operator is defined as in Eq. (2.3). If we consider, in particular, a trace class and self-adjoint operator A with eigenvalues a_k , the trace norm can be expressed as the sum of the absolute eigenvalues (counting multiplicity),

$$\|A\|_1 = \sum_k |a_k|. \quad (\text{C.2})$$

The trace distance of two quantum states, represented by positive operators ρ^1 and ρ^2 with unit trace, is thus given by

$$D(\rho^1, \rho^2) = \frac{1}{2} \|\rho^1 - \rho^2\|_1 = \frac{1}{2} \text{Tr} |\rho^1 - \rho^2| = \frac{1}{2} \sum_k |\varrho_k|, \quad (\text{C.3})$$

with ϱ_k eigenvalues of the traceless operator $\rho^1 - \rho^2$. The trace distance is a metric on the space of physical states with several properties which make it a useful measure for the distance between two quantum states.

1. The trace distance for any pair of states satisfies the inequality

$$0 \leq D(\rho^1, \rho^2) \leq 1, \quad (\text{C.4})$$

where $D(\rho^1, \rho^2) = 0$ if and only if $\rho^1 = \rho^2$, and $D(\rho^1, \rho^2) = 1$ if and only if ρ^1 and ρ^2 have orthogonal supports.

2. Being a metric, the trace distance satisfies the triangular inequality,

$$D(\rho^1, \rho^2) \leq D(\rho^1, \rho^3) + D(\rho^3, \rho^2). \quad (\text{C.5})$$

3. All trace preserving positive maps Λ are contractions of the trace distance,

$$D(\Lambda\rho^1, \Lambda\rho^2) \leq D(\rho^1, \rho^2), \quad (\text{C.6})$$

where the equality sign holds if Λ is a unitary transformation.

4. The trace distance is subadditive with respect to the tensor product,

$$D(\rho^1 \otimes \sigma^1, \rho^2 \otimes \sigma^2) \leq D(\rho^1, \rho^2) + D(\sigma^1, \sigma^2). \quad (\text{C.7})$$

In particular, one has

$$D(\rho^1 \otimes \sigma, \rho^2 \otimes \sigma) = D(\rho^1, \rho^2). \quad (\text{C.8})$$

5. The trace distance can be represented as a maximum taken over all projection operators Π or, equivalently, over all the positive operators $\Pi \leq \mathbb{1}$,

$$D(\rho^1, \rho^2) = \max_{\Pi} \text{Tr} \{ \Pi (\rho^1 - \rho^2) \}. \quad (\text{C.9})$$

The property 3. is an immediate consequence of the following theorem on the contractivity of trace norm under the action of positive trace preserving linear maps. We report it, together with the proof, because of its central role in the definition of a non-Markovianity measure as well as in the analysis of the dynamics of open quantum systems in the presence of initial correlations, see Chapter 5 and Appendix E.

Theorem [212, 81, 213] A trace preserving linear map Λ on the set of trace class operators is positive *if and only if*

$$\|\Lambda A\|_1 \leq \|A\|_1 \quad \forall A = A^\dagger \in \mathcal{T}(\mathcal{H}) \quad (\text{C.10})$$

Proof. Let Λ be a positive linear trace preserving map on $\mathcal{T}(\mathcal{H})$. For every positive trace-class operator ρ one has $\|\Lambda\rho\|_1 = \|\rho\|_1$. Consider now a self-adjoint trace class operator A which is not positive. By means of the spectral decomposition we can write it as $A = A^+ - A^-$, where the two positive operators A^+ and A^- are, respectively, the positive and the negative part of A , so that $\|A\|_1 = \|A^+\|_1 + \|A^-\|_1$. But then

$$\|\Lambda A\|_1 = \|\Lambda A^+ - \Lambda A^-\|_1 \leq \|\Lambda A^+\|_1 + \|\Lambda A^-\|_1 = \|A^+\|_1 + \|A^-\|_1 = \|A\|_1$$

and then Λ is a contraction on the set of self-adjoint trace class operators.

Conversely, let Λ be a linear trace preserving map on trace class operators which satisfies Eq. (C.10).

Then, given a positive operator ρ , one has

$$\|\rho\|_1 = \text{Tr}[\rho] = \text{Tr}[\Lambda\rho] \leq \|\Lambda\rho\|_1 \leq \|\rho\|_1,$$

so that $\text{Tr}[\Lambda\rho] = \|\Lambda\rho\|_1$. But then, since $\text{Tr}[\rho] = \|\rho\|_1$ if and only if ρ is positive, we can conclude that $\Lambda\rho$ is positive for any positive ρ , i.e., Λ is positive.

The physical interpretation of the trace distance can be based on Eq. (C.9) [214]. Suppose Alice prepares a system in one of two quantum state ρ^1 and ρ^2 with probability of 1/2 each. She gives the system to Bob, who performs a measurement in order to distinguish the two states. Employing Eq. (C.9) one can show that the maximal success probability for Bob to identify correctly the state is given by $[1 + D(\rho^1, \rho^2)] / 2$. This means that the trace distance represents the maximal bias in favor of the correct state identification which Bob can achieve through an optimal strategy. Hence, the trace distance $D(\rho^1, \rho^2)$ can be interpreted as a measure for the distinguishability of the quantum states ρ^1 and ρ^2 .

The trace distance is the quantum counterpart of the Kolmogorov distance for classical probability distributions. Given two probability distributions $\{p_k^1\}_{k \in \mathcal{X}}$ and $\{p_k^2\}_{k \in \mathcal{X}}$ on a common set \mathcal{X} , their Kolmogorov distance is defined as

$$D_K(\{p_k^1\}_{k \in \mathcal{X}}, \{p_k^2\}_{k \in \mathcal{X}}) = \frac{1}{2} \sum_k |p_k^1 - p_k^2|. \quad (\text{C.11})$$

Indeed, the Kolmogorov distance is a measure for the distinguishability of classical probability distributions [99]. Finally, note that if two statistical operators ρ^1 and ρ^2 can be diagonalized on the same basis, $\rho^1 = \sum_k \lambda_k^1 |k\rangle\langle k|$ and $\rho^2 = \sum_k \lambda_k^2 |k\rangle\langle k|$, then their trace distance is equal to the Kolmogorov distance between the probability distributions $\{\lambda_k^1\}$ and $\{\lambda_k^2\}$. For a more detailed comparison between Kolmogorov distance and trace distance, see [3].

Appendix D

General bound and non-convexity for correlations of a quantum state

We have used the quantity $D(\rho_{SE}, \rho_S \otimes \rho_E)$ as a measure for the total amount of correlations of the state ρ_{SE} , see in particular Chapter 5. We will now conjecture a bound for this quantity depending only on the dimensions of the Hilbert spaces \mathcal{H}_S and \mathcal{H}_E , showing that it is saturated by the pure maximally entangled states. We further show by means of example that this measure is not convex on the set of states on $\mathcal{H}_S \otimes \mathcal{H}_E$.

On the ground of extensive numerical simulations we conjecture that the correlations in an arbitrary state ρ_{SE} on the bipartite Hilbert space $\mathcal{H}_S \otimes \mathcal{H}_E$ satisfy the inequality

$$D(\rho_{SE}, \rho_S \otimes \rho_E) \leq 1 - \frac{1}{N^2}, \quad (\text{D.1})$$

where N denotes the minimum of the dimensions of \mathcal{H}_S and \mathcal{H}_E . For the example studied in Chapter 5 we have $N = 2$ and, hence, $D(\rho_{SE}, \rho_S \otimes \rho_E) \leq \frac{3}{4}$.

To our knowledge there exists no general mathematical proof for the inequality (D.1). However, one can easily prove that this inequality is saturated if $\rho_{SE} = |\phi\rangle\langle\phi|$ is a pure, maximally entangled state, see Eq. (2.28). To show this, we first note that for a maximally entangled state vector $|\phi\rangle$ the marginal states are given by $\rho_S = P_S/N$ and $\rho_E = P_E/N$, where P_S and P_E are the projections onto the subspaces of \mathcal{H}_S and \mathcal{H}_E , respectively, which are spanned by the local Schmidt basis vectors with nonzero Schmidt coefficients. Hence, $D(\rho_{SE}, \rho_S \otimes \rho_E)$ is given by $\frac{1}{2}$ times the sum of the absolute eigenvalues of the operator

$$X = |\phi\rangle\langle\phi| - \frac{1}{N^2} P_S \otimes P_E. \quad (\text{D.2})$$

Obviously, $|\phi\rangle$ is an eigenvector of X corresponding to the eigenvalue $1 - 1/N^2$. Moreover, all vectors which are perpendicular to $|\phi\rangle$ and belong to the support of $P_S \otimes P_E$ are eigenvectors of X with the eigenvalue $-1/N^2$. Thus, X has one non-degenerate eigenvalue $1 - 1/N^2$, and one eigenvalue $-1/N^2$ which is $(N^2 - 1)$ -fold degenerate, while all other eigenvalues of X are zero. Therefore we have

$$D(\rho_{SE}, \rho_S \otimes \rho_E) = \frac{1}{2} \left[1 - \frac{1}{N^2} + (N^2 - 1) \frac{1}{N^2} \right] = 1 - \frac{1}{N^2}, \quad (\text{D.3})$$

which proves the claim.

The measure of correlations contained in a bipartite state ρ_{SE} is not convex on the set of states on $\mathcal{H}_S \otimes \mathcal{H}_E$: a mixture of product states is not generally a product state. Consider the mixed state

$$\rho_{SE} = \frac{1}{N} \sum_{i=1}^N |\psi_S^i, \varphi_E^i\rangle \langle \psi_S^i, \varphi_E^i|, \quad (\text{D.4})$$

and let us denote by P_S and P_E the projections on the subspaces of \mathcal{H}_S and \mathcal{H}_E generated by the set of orthonormal vectors $\{|\psi_S^i\rangle\}_{i=1,\dots,N}$ and $\{|\varphi_E^i\rangle\}_{i=1,\dots,N}$ respectively. The state ρ_{SE} is separable and has in particular zero quantum discord in either direction, still its correlations have the finite value

$$D(\rho_{SE}, \rho_S \otimes \rho_E) = 1 - \frac{1}{N}. \quad (\text{D.5})$$

Since it is a convex combination of product states with zero correlations, this implies in particular the non-convexity of the considered correlation measure. To prove Eq. (D.5) note that $D(\rho_{SE}, \rho_S \otimes \rho_E)$ is given by $\frac{1}{2}$ times the sum of the absolute eigenvalues of the operator

$$Y = \frac{1}{N} P_{SE} - \frac{1}{N^2} P_S \otimes P_E, \quad (\text{D.6})$$

where P_{SE} denotes the projection on the subspace generated by $\{|\psi_S^i, \varphi_E^i\rangle\}_{i=1,\dots,N}$. One clearly has $P_{SE} < P_S \otimes P_E$. All vectors in the support of P_{SE} are eigenvectors of Y with the eigenvalue $1/N - 1/N^2$, while vectors orthogonal to P_{SE} but in the support of $P_S \otimes P_E$ are eigenvectors of Y with the eigenvalue $-1/N^2$. The operator Y thus has two degenerate eigenvalues different from zero: $(1/N - 1/N^2)$ with multiplicity N , and $-1/N^2$ which is $(N^2 - N)$ -fold degenerate. As a result

$$D(\rho_{SE}, \rho_S \otimes \rho_E) = \frac{1}{2} \left[N \left(\frac{1}{N} - \frac{1}{N^2} \right) + (N^2 - N) \frac{1}{N^2} \right] = 1 - \frac{1}{N}.$$

Appendix E

Measure of non-Markovianity

In this Appendix, we briefly recall the definition and the physical meaning of the non-Markovianity measure based on trace distance which has been introduced in [19, 21]. Moreover, we analyze its relation with P-divisibility, see Sec. (4.2).

As discussed in Appendix C, the trace distance quantifies the distinguishability between quantum states. Its use in order to characterize the dynamics of open quantum systems originates from the idea that a change in the distinguishability of reduced states can be interpreted as an information flow between the open system and the environment. For example, a decrease of trace distance indicates an information flow from the open system to the environment, such that the possibility to discriminate between two reduced states is lowered. The invariance of trace distance under unitary transformations shows that the information is preserved in the evolution of closed systems. On the other hand, given a semigroup dynamics $\{\Lambda(t, 0)\}_{t \geq 0}$, for any pair of initial states $\rho_S^1(0)$ and $\rho_S^2(0)$ and for any $t, s \geq 0$, one has

$$D(\rho_S^1(t+s), \rho_S^2(t+s)) \leq D(\rho_S^1(s), \rho_S^2(s)), \quad (\text{E.1})$$

since the semigroup property implies $\rho_S(t+s) = \Lambda(t, 0)\rho_S(s)$ and the trace distance cannot increase under positive trace preserving maps, see Eq. (C.6). The monotonically non-increasing behavior of the trace distance indicates that the information flows continuously from the open system to the environment. In [19, 21] Markovian quantum dynamics are precisely identified as those dynamics characterized by a unidirectional flow of information from the open system to the environment. Any increase of the trace distance, which indicates a back flow of information from the environment to the open system, is then a signature of non-Markovian dynamics. Consequently, a measure of non-Markovianity $\mathcal{N}(\Lambda)$, for a time evolution described by $\{\Lambda(t, 0)\}_{t \geq 0}$, can be build by introducing the rate

$$\sigma\left(t, \rho_S^{1,2}(0)\right) = \frac{d}{dt} D\left(\rho_S^1(t), \rho_S^2(t)\right). \quad (\text{E.2})$$

The measure $\mathcal{N}(\Lambda)$ is then defined by integrating $\sigma(t, \rho_S^{1,2}(0))$ over the time region, let us call it Ω_+ , where it is positive, and maximizing the result over all possible initial pairs of states, thus coming to

$$\mathcal{N}(\Lambda) = \max_{\rho_S^{1,2}(0)} \int_{\Omega_+} dt \sigma\left(t, \rho_S^{1,2}(0)\right). \quad (\text{E.3})$$

Note that due to the maximization over all initial pairs of state, the non-Markovianity measure defined in Eq. (E.3) is a property of the family of dynamical maps which describes the evolution. Furthermore, this measure of non-Markovianity provides a clear criterion to experimentally detect non-Markovianity: one has to reconstruct, typically by state tomography, different reduced states at different times to check whether the trace distance has increased. No information about the environment or about system-environment interaction is needed. In [215] the transition between Markovian and non-Markovian dynamics by controlling the information flow is realized in an all-optical experiment, while in [216] the dynamics with the highest back flow of information among a class of non-Markovian dynamics is experimentally identified.

The non-Markovianity measure defined in Eq. (E.3) relies on the contractivity of the trace norm under positive and trace preserving maps. This statement can be clarified by means of the following theorem.

Theorem For a bijective evolution $\{\Lambda(t, 0)\}_{t \geq 0}$, i.e. $\Lambda^{-1}(t, 0)$ exists for any $t \geq 0$, $\mathcal{N}(\Lambda) = 0$ if and only if the transition map $\Lambda(t, s)$ is a contraction on any *traceless* self-adjoint operator with respect to the trace norm, for any $t, s \geq 0$.

Proof. Since $\rho_S^1(s) - \rho_S^2(s)$ is a traceless operator the "if" part of the theorem is trivial. Conversely, given an evolution such that $\mathcal{N}(\Lambda) = 0$, then

$$\|\Lambda(t, s)(\tilde{\rho}_S^1(s) - \tilde{\rho}_S^2(s))\|_1 \leq \|\tilde{\rho}_S^1(s) - \tilde{\rho}_S^2(s)\|_1 \quad \forall \tilde{\rho}_S^1(s), \tilde{\rho}_S^2(s) \in \Lambda(s, 0) [\mathcal{S}(\mathcal{H})], \quad (\text{E.4})$$

where $\Lambda(s, 0) [\mathcal{S}(\mathcal{H})]$ indicates the image of the set of statistical operators $\mathcal{S}(\mathcal{H})$ under the map $\Lambda(s, 0)$. Note that $\Lambda(s, 0) [\mathcal{S}(\mathcal{H})]$ and $\mathcal{S}(\mathcal{H})$ have the same dimension since $\Lambda(s, 0)$ is invertible. Then, Eq. (E.4) implies that the same inequality, $\|\Lambda(t, s)(\rho_S^1 - \rho_S^2)\|_1 \leq \|\rho_S^1 - \rho_S^2\|_1$, holds for any pair of statistical operators ρ_S^1 and ρ_S^2 , which can be shown as follows.

For any pair of states ρ_S^1 and ρ_S^2 , there are three states $\tilde{\rho}_S^0(s)$, $\tilde{\rho}_S^1(s)$ and $\tilde{\rho}_S^2(s)$ inside the range of $\Lambda(s, 0)$ such that

$$\begin{aligned} \tilde{\rho}_S^1(s) &= \lambda \rho_S^1 + (1 - \lambda) \tilde{\rho}_S^0(s) \\ \tilde{\rho}_S^2(s) &= \lambda \rho_S^2 + (1 - \lambda) \tilde{\rho}_S^0(s), \end{aligned}$$

with $0 \leq \lambda \leq 1$, where we exploited the convex structure of the set of states and the dimensionality of the range of $\Lambda(s, 0)$. Now, suppose that there is a pair of states ρ_S^1 and ρ_S^2 such that $\|\Lambda(t, s)(\rho_S^1 - \rho_S^2)\|_1 > \|\rho_S^1 - \rho_S^2\|_1$, but then

$$\|\Lambda(t, s)(\tilde{\rho}_S^1(s) - \tilde{\rho}_S^2(s))\|_1 = \lambda \|\Lambda(t, s)(\rho_S^1 - \rho_S^2)\|_1 > \lambda \|\rho_S^1 - \rho_S^2\|_1 = \|\tilde{\rho}_S^1(s) - \tilde{\rho}_S^2(s)\|_1,$$

which proves our claim.

The theorem is then proved by observing that any traceless self-adjoint operator can be written as the difference between two statistical operators, by means of the spectral decomposition.

Let us emphasize that this is not enough in order to guarantee that the transition maps $\Lambda(t, s)$ are positive. In the Theorem in Appendix C it is shown that, given a trace preserving map, the positivity is equivalent to the contractivity on *every* self-adjoint operator. But the contractivity on

traceless self-adjoint operators does not imply the contractivity on all the self-adjoint operators. Consider for simplicity a two-level system, see Sec. (2.2.4). Then, any deformation of the Bloch sphere consisting in a contraction plus a translation such that at least a portion of the Bloch sphere is translated out of the unit ball describes a map which is a contraction on any traceless self-adjoint operator, but which is not positive. Starting from this example, one can see that even if every P-divisible family of dynamical maps $\{\Lambda(t, 0)\}_{t \geq 0}$, see Sec. (4.2), satisfies $\mathcal{N}(\Lambda) = 0$, the opposite statement is not true¹: there are dynamics with a monotonically decreasing trace distance, but which are not P-divisible. Note that this is the case also for the evolution of the one-point probability of a classical process, where, indeed, the Kolmogorov distance replaces the trace distance, see Sec. (4.1.5) and Appendix C.

Finally, on a two-level system, every bistochastic map which is a contraction on traceless self-adjoint operators is a contraction also on all the self-adjoint operators, so that for a family of bistochastic dynamical maps on a two-level system P-divisibility and Markovianity, according to the measure $\mathcal{N}(\Lambda)$, actually coincide. Any bistochastic map of a two level system can be represented with respect to the basis $\{\mathbb{1}/\sqrt{2}, \sigma_k/\sqrt{2}\}_{k=x,y,z}$, see Eq. (2.77), as

$$\Lambda = \begin{pmatrix} 1 & \mathbf{0} \\ 0 & B \end{pmatrix},$$

where B is a 3×3 matrix, while every traceless self-adjoint operator γ is associated with a vector $(0 \quad \mathbf{v})^T$, with $\mathbf{v} \in \mathbb{R}^3$. Indeed, γ has two opposite eigenvalues, let us say g and $-g$, so that $\|\gamma\|_1 = |g|$. The operator $\delta = \Lambda\gamma$ is represented by the vector $(0 \quad B\mathbf{v})^T$, and let us call its eigenvalues d and $-d$. Then, since Λ is a contraction on traceless operators, $\|\delta\|_1 = \|\Lambda\gamma\|_1 \leq \|\gamma\|_1$, that is $|d| \leq |g|$. Now consider the self-adjoint operator γ' represented by $(\sqrt{2}a \quad \mathbf{v})^T$, with eigenvalues $a + g$ and $a - g$, so that $\|\gamma'\|_1 = \max\{|a|, |g|\}$. The operator $\delta' = \Lambda\gamma'$ is represented by $(\sqrt{2}a \quad B\mathbf{v})^T$, and one has $\|\delta'\|_1 = \max\{|a|, |d|\}$, so that $\|\Lambda\gamma'\|_1 = \|\delta'\|_1 \leq \|\gamma'\|_1$. The same can be done for any self-adjoint operator, and then, in the case of bistochastic maps on two-level systems, contractivity on traceless self-adjoint operators guarantees contractivity on every self-adjoint operator. It can be shown that this is no longer true in higher dimensions.

¹In Sec. (4.2.3) we provided some examples of evolutions with non-Markovianity measure $\mathcal{N}(\Lambda) = 0$, but which are not CP-divisible. Nevertheless, those evolutions are P-divisible.

Appendix F

Fourth order time-convolutionless master equation for the damped two-level system

We here consider the fourth order contribution of the time-convolutionless projection operator technique for the damped two-level system considered in Section 3.2.4. We recall that the third order vanishes for the present model. The fourth order contribution in Eq. (3.88), after expanding $\Sigma(t)$, reads

$$\begin{aligned} \mathcal{K}_{TCL}^{(4)}(t) = & \int_0^t dt_1 \int_0^{t_1} dt_2 \int_0^{t_2} dt_3 [PL(t)L(t_1)L(t_2)L(t_3)P - PL(t)L(t_1)PL(t_2)L(t_3)P \\ & - PL(t)L(t_2)PL(t_1)L(t_3)P - PL(t)L(t_3)PL(t_1)L(t_2)P]. \end{aligned} \quad (\text{F.1})$$

The corresponding contribution to the time-convolutionless master equation for the reduced dynamics is then

$$\begin{aligned} K_{TCL}^{(4)}(t)\rho(t) = & \text{tr}_E \left\{ \int_0^t dt_1 \int_0^{t_1} dt_2 \int_0^{t_2} dt_3 \right. \\ & \times [PL(t)L(t_1)L(t_2)L(t_3)P\rho(t) \otimes \rho_E - P\mathcal{L}(t)L(t_1)PL(t_2)\mathcal{L}(t_3)P\rho(t) \otimes \rho_E \\ & \left. - PL(t)L(t_2)PL(t_1)L(t_3)P\rho(t) \otimes \rho_E - PL(t)L(t_3)PL(t_1)L(t_2)P\rho(t) \otimes \rho_E \right\}. \end{aligned} \quad (\text{F.2})$$

We recall that such high order contributions are needed in order to check the appearance, for an environmental state different from the vacuum, of the dephasing term $\sigma_z \rho(t) \sigma_z - \rho(t)$, which involves expressions with altogether four raising and lowering operators of the two-level system. To consider the fourth order contribution one has to evaluate the four terms given in Eq. (F.2). The last three terms at the right hand side can be obtained applying twice the result Eq. (3.95), thus

obtaining

$$\begin{aligned}
 & PL(t)L(t_\alpha)PL(t_\beta)L(t_\gamma)P\rho \otimes \rho_E = \\
 & [-4\sigma_+\rho\sigma_-\{\text{Re } f(t-t_\alpha)\text{Re } g(t_\beta-t_\gamma) + \text{Re } g(t-t_\alpha)\text{Re } g(t_\beta-t_\gamma)\} \\
 & -4\sigma_-\rho\sigma_+\{\text{Re } g(t-t_\alpha)\text{Re } f(t_\beta-t_\gamma) + \text{Re } f(t-t_\alpha)\text{Re } f(t_\beta-t_\gamma)\} \\
 & +\sigma_+\sigma_-\rho f(t-t_\alpha)f(t_\beta-t_\gamma) + \rho\sigma_+\sigma_-\rho f^*(t-t_\alpha)f^*(t_\beta-t_\gamma) \\
 & +\sigma_-\sigma_+\rho g(t-t_\alpha)g(t_\beta-t_\gamma) + \rho\sigma_-\sigma_+\rho g^*(t-t_\alpha)g^*(t_\beta-t_\gamma) \\
 & +\sigma_+\sigma_-\rho\sigma_+\sigma_-\{2\text{Re } [f(t-t_\alpha)f^*(t_\beta-t_\gamma)] + 4\text{Re } g(t-t_\alpha)\text{Re } f(t_\beta-t_\gamma)\} \\
 & +\sigma_-\sigma_+\rho\sigma_-\sigma_+\{2\text{Re } [g(t-t_\alpha)g^*(t_\beta-t_\gamma)] + 4\text{Re } f(t-t_\alpha)\text{Re } g(t_\beta-t_\gamma)\} \\
 & +\sigma_-\sigma_+\rho\sigma_+\sigma_-\{f^*(t-t_\alpha)g(t_\beta-t_\gamma) + g(t-t_\alpha)f^*(t_\beta-t_\gamma)\} \\
 & +\sigma_+\sigma_-\rho\sigma_-\sigma_+\{g^*(t-t_\alpha)f(t_\beta-t_\gamma) + f(t-t_\alpha)g^*(t_\beta-t_\gamma)\} \otimes \rho_E, \tag{F.3}
 \end{aligned}$$

where the relations $\sigma_+^2 = \sigma_-^2 = 0$ have been repeatedly used, together with the assumption $[\rho_E, n_k] = 0$.

The first term at the right hand side of Eq. (F.2) instead requires the introduction of a four-point correlation function, which is given by

$$h(t_a, t_b, t_c, t_d) = e^{i\omega_0(t_a-t_b+t_c-t_d)} \text{tr}_E \left\{ B(t_a)B^\dagger(t_b)B(t_c)B^\dagger(t_d)\rho_E \right\}, \tag{F.4}$$

with $B(t)$ as in Eq. (3.91). An explicit evaluation of $PL(t)L(t_1)L(t_2)\mathcal{L}(t_3)P\rho \otimes \rho_E$ together with the repeated use of Eq. (F.3) then leads to the desired result, which can be obtained with a straightforward though very lengthy calculation. The fourth order contribution reads

$$\begin{aligned}
 K_{\text{TCL}}^{(4)}(t)\rho(t) = & i[\mathbf{p}_I(t) + \mathbf{r}_I(t) + \mathbf{v}_I(t)] [\sigma_+\sigma_-, \rho(t)] + \mathbf{t}(t) \left[\sigma_+\rho(t)\sigma_- - \frac{1}{2} \{\sigma_-\sigma_+, \rho(t)\} \right] \\
 & + \mathbf{u}(t) \left[\sigma_-\rho(t)\sigma_+ - \frac{1}{2} \{\sigma_+\sigma_-, \rho(t)\} \right] + \frac{1}{4} [\mathbf{q}(t) + \mathbf{s}(t) + 2\mathbf{v}_R(t)] [\sigma_z\rho\sigma_z - \rho], \tag{F.5}
 \end{aligned}$$

where in analogy to the notation of Eq. (3.97) we use the Fraktur character to denote the triple integral over time of the function with the corresponding Roman letter, for example

$$\mathbf{p}(t) = \int_0^t dt_1 \int_0^{t_1} dt_2 \int_0^{t_2} dt_3 p(t, t_1, t_2, t_3). \tag{F.6}$$

The functions determining the coefficients appearing in Eq. (F.5) are given in terms of the above introduced two- and four-points correlation functions of the model according to the expressions

$$\begin{aligned}
p(t, t_1, t_2, t_3) &= - \sum_{\alpha\beta\gamma} f(t - t_\alpha) f(t_\beta - t_\gamma) + h(t, t_1, t_2, t_3) \\
q(t, t_1, t_2, t_3) &= -2 \sum_{\alpha\beta\gamma} \{ \text{Re} [f(t - t_\alpha) f^*(t_\beta - t_\gamma)] + 2 \text{Re} g(t - t_\alpha) \text{Re} f(t_\beta - t_\gamma) - \text{Re} h(t_\alpha, t, t_\beta, t_\gamma) \} \\
r(t, t_1, t_2, t_3) &= g(t - t_2) g(t_1 - t_3) + g(t - t_3) g(t_1 - t_2) + f(t_1 - t) f(t_3 - t_2) - h(t_1, t, t_3, t_2) \\
s(t, t_1, t_2, t_3) &= -2 \sum_{\alpha\beta\gamma} \{ \text{Re} [f(t - t_\alpha) f(t_\gamma - t_\beta)] + 2 \text{Re} f(t - t_\alpha) \text{Re} g(t_\beta - t_\gamma) - \text{Re} h(t, t_\alpha, t_\gamma, t_\beta) \} \\
t(t, t_1, t_2, t_3) &= 2 \sum_{\alpha\beta\gamma} \{ \text{Re} [f(t - t_\alpha) f(t_\gamma - t_\beta)] + \text{Re} [g(t - t_\alpha) g(t_\beta - t_\gamma)] \\
&\quad + 2 \text{Re} f(t - t_\alpha) \text{Re} g(t_\beta - t_\gamma) - \text{Re} h(t, t_\alpha, t_\gamma, t_\beta) \} \\
&\quad + 2 \{ \text{Re} [f(t_1 - t) f(t_3 - t_2)] - \text{Re} [g(t - t_1) g(t_2 - t_3)] - \text{Re} h(t_1, t, t_3, t_2) \} \\
u(t, t_1, t_2, t_3) &= 2 \sum_{\alpha\beta\gamma} \{ \text{Re} f(t - t_\alpha) \text{Re} f(t_\beta - t_\gamma) + 2 \text{Re} g(t - t_\alpha) \text{Re} f(t_\beta - t_\gamma) - \text{Re} h(t_\alpha, t, t_\beta, t_\gamma) \} \\
&\quad - 2 \text{Re} h(t, t_1, t_2, t_3) \\
v(t, t_1, t_2, t_3) &= 2 \sum_{\alpha\beta\gamma} \{ f(t_\alpha - t) f(t_\gamma - t_\beta) - h(t_\alpha, t, t_\gamma, t_\beta) \}, \tag{F.7}
\end{aligned}$$

where the following summation convention has been used

$$\sum_{\alpha\beta\gamma} \psi(t_\alpha, t_\beta, t_\gamma) = \psi(t_1, t_2, t_3) + \psi(t_2, t_1, t_3) + \psi(t_3, t_1, t_2). \tag{F.8}$$

Including terms up to fourth order one therefore has the expression Eq. (3.98) with time dependent coefficients given by the identifications

$$\begin{aligned}
\gamma_s(t) &= -\mathbf{f}(t) - \mathbf{g}(t) + \mathbf{p}(t) + \mathbf{r}(t) + \mathbf{v}(t) \\
\gamma_+(t) &= 2\mathbf{f}_R(t) + \mathbf{t}(t) \\
\gamma_-(t) &= 2\mathbf{g}_R(t) + \mathbf{u}(t) \\
\gamma_d(t) &= \mathbf{q}(t) + \mathbf{s}(t) + 2\mathbf{v}_R(t). \tag{F.9}
\end{aligned}$$

Bibliography

- [1] H.-P. Breuer and F. Petruccione. *The Theory of Open Quantum Systems*. Oxford University Press, Oxford, 2002.
- [2] E. Joos, H.D. Zeh, C. Kiefer, D. Giulini, J. Kupsch, and I.-O. Stamatescu. *Decoherence and the Appearance of a Classical World in Quantum Theory*. Springer-Verlag, Berlin, 2nd edition, 2003.
- [3] M. A. Nielsen and I. L. Chuang. *Quantum Computation and Quantum Information*. Cambridge University Press, Cambridge, 2000.
- [4] D.F. Walls and G.J. Milburn. *Quantum Optics*. Springer-Verlag, Berlin, 2nd edition, 1994.
- [5] G. Ludwig. *Foundations of Quantum Mechanics I*. Springer-Verlag, New York, 1983.
- [6] G. Ludwig. *Foundations of Quantum Mechanics II*. Springer-Verlag, New York, 1983.
- [7] A.S. Holevo. *Probabilistic and Statistical Aspects of Quantum Theory*. North-Holland Publishing Co., Amsterdam, 1982.
- [8] K. Kraus. *States, Effects and Operations: Fundamental Notions of Quantum Theory*. Springer, Berlin, 1983.
- [9] A. Bassi and G.C. Ghirardi. A general argument against the universal validity of the superposition principle. *Phys. Lett. A*, 275:373, 2000.
- [10] L. Lanz, F. Belgiorno, and B. Vacchini. Macro-objectivation: a challenge in quantum field theory. *AIP Conf. Proc.*, 884:244, 2006.
- [11] L. Lanz, O. Melsheimer, and B. Vacchini. Description of isolated macroscopic systems inside quantum mechanics. *Rep. Math. Phys.*, 46:191, 2000.
- [12] L. Lanz, O. Melsheimer, and B. Vacchini. Physics of a microsystem starting from non-equilibrium quantum statistical mechanics. *Rep. Math. Phys.*, 49:279, 2002.
- [13] L. Lanz, B. Vacchini, and O. Melsheimer. Quantum theory: the role of microsystems and macrosystems. *J. Phys. A: Math. Theor.*, 40:3123, 2007.

- [14] V. Gorini, A. Kossakowski, and E. C. G. Sudarshan. Completely positive dynamical semi-groups of N -level systems. *J. Math. Phys.*, 17:821, 1976.
- [15] G. Lindblad. On the generators of quantum dynamical semigroups. *Comm. Math. Phys.*, 48:119, 1976.
- [16] G. S. Engel, T.R Calhoun, E.L. Read, T.Y. Ahn, T. Mančal, Y.C. Cheng, R.E. Blankenship, and G.R. Fleming. Evidence for wavelike energy transfer through quantum coherence in photosynthetic systems. *Nature*, 446:782, 2007.
- [17] A. Ishizaki and G.R. Fleming. Unified treatment of quantum coherent and incoherent hopping dynamics in electronic energy transfer: Reduced hierarchy equation approach. *J. Chem. Phys.*, 130:234111, 2009.
- [18] M. M. Wolf, J. Eisert, T. S. Cubitt, and J. I. Cirac. Assessing non-Markovian quantum dynamics. *Phys. Rev. Lett.*, 101:150402, 2008.
- [19] H.-P. Breuer, E. M. Laine, and J. Piilo. Measure for the degree of non-Markovian behavior of quantum processes in open systems. *Phys. Rev. Lett.*, 103:210401, 2009.
- [20] A. Rivas, S. F. Huelga, and M. B. Plenio. Entanglement and non-Markovianity of quantum evolutions. *Phys. Rev. Lett.*, 105:050403, 2010.
- [21] E.-M. Laine, J. Piilo, and H.-P. Breuer. Measure for the non-Markovianity of quantum processes. *Phys. Rev. A*, 81:062115, 2010.
- [22] P. Pechukas. Reduced dynamics needs not be completely positive. *Phys. Rev. Lett.*, 73:1060, 1994.
- [23] A. Alicki. Comment on "Reduced dynamics needs not be completely positive". *Phys. Rev. Lett.*, 75:3020, 1994.
- [24] P. Pechukas. Reply on "Reduced dynamics needs not be completely positive". *Phys. Rev. Lett.*, 75:3021, 1994.
- [25] T. F. Jordan. Maps and inverse maps in open quantum dynamics. *Ann. Phys. (N.Y.)*, 325:2075, 2010.
- [26] E.-M. Laine, J. Piilo, and H.-P. Breuer. Witness for initial system-environment correlations in open-system dynamics. *Europhys. Lett.*, 92:60010, 2010.
- [27] A. Smirne, D. Brivio, S. Cialdi, B. Vacchini, and M.G.A. Paris. Experimental investigation of initial system-environment correlations via trace distance evolution. *Phys. Rev. A*, 84:032112, 2011.
- [28] A. Smirne and B. Vacchini. Nakajima-Zwanzig versus time-convolutionless master equation for the non-Markovian dynamics of a two-level system. *Phys. Rev. A*, 82:022110, 2010.

-
- [29] A. Smirne and B. Vacchini. Quantum master equation for collisional dynamics of massive particles with internal degrees of freedom. *Phys. Rev. A*, 82:042111, 2010.
- [30] A. Smirne, H.-P Breuer, J. Piilo, and B. Vacchini. Initial correlations in open system's dynamics: The Jaynes-Cummings model. *Phys. Rev. A*, 82:062114, 2010.
- [31] B. Vacchini, A. Smirne, E.-M. Laine, J. Piilo, and H.-P. Breuer. Markovianity and non-Markovianity in quantum and classical systems. *New J. Phys.*, 13:093004, 2011.
- [32] A. S. Holevo. *Statistical Structure of Quantum Theory*, volume m 67 of *Lecture Notes in Physics*. Springer, Berlin, 2001.
- [33] R. Alicki and M. Fannes. *Quantum dynamical systems*. Oxford University Press, Oxford, 2001.
- [34] F. Strocchi. *An Introduction to the Mathematical Structure of Quantum Mechanics*. World Scientific, 2005.
- [35] B. Vacchini. *Covariant Mappings for the Description of Measurement, Dissipation and Decoherence in Quantum Mechanics*. edited by E. Brüning and F. Petruccione, Lecture Notes in Physics 787, 39. Springer, Berlin, 2010.
- [36] M. Reed and B. Simon. *Methods of Modern Mathematical Physics*, volume I. Academic Press, San Diego, 1980.
- [37] J. von Neumann. *Mathematical Foundations of Quantum Mechanics*. Princeton University Press, Princeton, 1955.
- [38] R. F. Werner. Quantum states with Einstein-Podolsky-Rosen correlations admitting a hidden-variable model. *Phys. Rev. A*, 40:4277, 1989.
- [39] E. Schrödinger. Die gegenwärtige Situation in der Quantenmechanik. *Naturwissenschaften*, 23:844, 1935.
- [40] A. Einstein, B. Podolsky, and N. Rosen. Can quantum-mechanical description of physical reality be considered complete? *Phys. Rev.*, 47:777, 1935.
- [41] R. Horodecki, P. Horodecki, M. Horodecki, and K. Horodecki. Quantum entanglement. *Rev. Mod. Phys.*, 81:865, 2009.
- [42] L. Henderson and V. Vedral. Classical, quantum and total correlations. *J. Phys. A: Math. Gen.*, 34:6899, 2001.
- [43] H. Ollivier and W. H. Zurek. Quantum discord: A measure of the quantumness of correlations. *Phys. Rev. Lett.*, 88:017901, 2001.
- [44] K. Modi, T. Paterek, W. Son, V. Vedral, and M. Williamson. Unified view of quantum and classical correlations. *Phys. Rev. Lett.*, 104:080501, 2010.

- [45] A. Ferraro, L. Aolita, D. Cavalcanti, F. M. Cucchietti, and A. Acín. Almost all quantum states have nonclassical correlations. *Phys. Rev. A*, 81:052318, 2010.
- [46] A. Rivas and S. F. Huelga. Introduction to the time evolution of open quantum systems. 2011. arXiv:1104.5242.
- [47] M. Asorey, A. Kossakowski, G. Marmo, and E. C. G. Sudarshan. Dynamical maps and density matrices. *J. Phys.: Conf. Ser.*, 196:012023, 2009.
- [48] D. Chruściński, A. Kossakowski, P. Aniello, G. Marmo, and F. Ventriglia. A class of commutative dynamics of open quantum systems. *Open Syst. Inf. Dyn.*, 17:255, 2010.
- [49] E. C. G. Sudarshan, P. M. Mathews, and J. Rau. Stochastic dynamics of quantum-mechanical systems. *Phys. Rev.*, 121:920, 1961.
- [50] T. F. Jordan and E. C. G. Sudarshan. Dynamical mappings of density operators in quantum mechanics. *J. Math. Phys.*, 2:772, 1961.
- [51] M. D. Choi. Positive linear maps on C^* -algebras. *Can. J. Math.*, 3:520, 1972.
- [52] M. D. Choi. Completely positive linear maps on complex matrices. *Lin. Alg. Appl.*, 10:285, 1975.
- [53] K. Kraus. General state changes in quantum theory. *Ann. Phys.*, 64:311, 1971.
- [54] I. Bengtsson and K. Życzkowski. *Geometry of quantum states: an introduction to quantum entanglement*. Cambridge University Press, Cambridge, 2006.
- [55] A. Jamiołkowski. Linear transformations which preserve trace and positive semidefiniteness of operators. *Rep. Math. Phys.*, 3:275, 1972.
- [56] E. Andersson, J. D. Cresser, and M. J. W. Hall. Finding the Kraus decomposition from a master equation and vice versa. *J. Mod. Opt.*, 54:1695, 2007.
- [57] H.-J. Briegel and B.-G. Englert. Quantum optical master equations: the use of damping bases. *Phys. Rev. A*, 47:3311, 1993.
- [58] C. King and M.B. Ruskai. Minimal entropy of states emerging from noisy quantum channels. *IEEE Trans. Info. Theory*, 47:192, 2001.
- [59] M.B. Ruskai, S. Szarek, and E. Werner. An analysis of completely-positive trace-preserving maps on M_2 . *Lin. Alg. Appl.*, 347:159, 2002.
- [60] W. F. Stinespring. Positive functions on C^* -algebras. *Proc. Amer. Math. Soc.*, 6:211, 1955.
- [61] S. Nakajima. On quantum theory of transport phenomena. *Progr. Theor. Phys.*, 20:948, 1958.

-
- [62] R. Zwanzig. Ensemble method in the theory of irreversibility. *J. Chem. Phys.*, 33:1338, 1960.
- [63] C. Cohen-Tannoudji, J. Dupont-Roc, and G. Grynberg. *Atom-Photon Interactions*. John Wiley & Sons, New York, 1992.
- [64] S. Chaturvedi and F. Shibata. Time-convolutionless projection operator formalism for elimination of fast variables. Applications to Brownian motion. *Z. Phys. B*, 35:297, 1979.
- [65] F. Shibata and T. Arimitsu. Expansion formulas in nonequilibrium statistical mechanics. *J. Phys. Soc. Jpn.*, 49:891, 1980.
- [66] H.-P. Breuer, B. Kappler, and F. Petruccione. Stochastic wave-function method for non-Markovian quantum master equations. *Phys. Rev. A*, 59:1633, 1999.
- [67] H.-P. Breuer, B. Kappler, and F. Petruccione. The time-convolutionless projection operator technique in the quantum theory of dissipation and decoherence. *Ann. Physics*, 291:36, 2001.
- [68] A. Kossakowski and R. Rebolledo. On the structure of generators for non-Markovian master equations. *Open Syst. Inf. Dyn.*, 16:259, 2009.
- [69] D. Chruściński and A. Kossakowski. Non-Markovian quantum dynamics: Local versus nonlocal. *Phys. Rev. Lett.*, 104:070406, 2010.
- [70] D. Chruściński and A. Kossakowski. General form of quantum evolution. 2010. arXiv:1006.2764.
- [71] A. J. van Wonderen and K. Lendi. Virtues and limitations of Markovian master equations with a time-dependent generator. *J. Stat. Phys.*, 100:633, 2000.
- [72] A. Shabani and D. A. Lidar. Completely positive post-Markovian master equation via a measurement approach. *Phys. Rev. A*, 71:020101, 2005.
- [73] S. Maniscalco. Complete positivity of a spin-1/2 master equation with memory. *Phys. Rev. A*, 75:062103, 2007.
- [74] R.R. Puri. *Mathematical Methods of Quantum Optics*. Springer, Berlin, 2001.
- [75] J. Salo, S.M. Barnett, and S. Stenholm. Non-Markovian thermalisation of a two-level atom. *Opt. Commun.*, 259:772, 2006.
- [76] J. Cresser and C. Facer. Master equations with memory for systems driven by classical noise. *Opt. Commun.*, 283:773, 2010.
- [77] B. Vacchini and H.-P. Breuer. Exact master equations for the non-Markovian decay of a qubit. *Phys. Rev. A*, 81:042103, 2010.

- [78] A. Frigerio, J.T. Lewis, and J. V. Pulé. The averaging method for asymptotic evolutions. II. Quantum open systems. *J. Approx. Th.*, 45:310, 1985.
- [79] N. G. van Kampen. A cumulant expansion for stochastic linear differential equations. I. *Physica*, 74:215, 1974.
- [80] N. G. van Kampen. A cumulant expansion for stochastic linear differential equations. II. *Physica*, 74:239, 1974.
- [81] A. Kossakowski. On quantum statistical mechanics of non-Hamiltonian systems. *Rep. Math. Phys.*, 3:247, 1972.
- [82] F. Benatti and R. Floreanini. Open quantum dynamics: Complete positivity and entanglement. *Int.J.Mod.Phys. B*, 19:3063, 2005.
- [83] E. B. Davies. Markovian master equations. *Commun. Math. Phys.*, 39:91, 1974.
- [84] E. B. Davies. Markovian master equations. II. *Math. Ann.*, 219:147, 1976.
- [85] V. Gorini and A. Kossakowski. N-level system in contact with a singular reservoir. *J. Math. Phys.*, 17:1298, 1976.
- [86] A. Frigerio and V. Gorini. N-level system in contact with a singular reservoir. II. *J. Math. Phys.*, 17:2123, 1976.
- [87] M. M. Wolf and J. I. Cirac. Dividing quantum channels. *Commun. Math. Phys.*, 279:147, 2008.
- [88] M. J. W. Hall. Complete positivity for time-dependent qubit master equations. *J. Phys. A: Math. Gen.*, 41:205302, 2008.
- [89] S. M. Barnett and S. Stenholm. Hazards of reservoir memory. *Phys. Rev. A*, 64:033808, 2001.
- [90] A. Kossakowski and R. Rebolledo. On completely positive non-Markovian evolution of a d-level system. *Open Syst. Inf. Dyn.*, 15:135, 2008.
- [91] D. Chruściński and A. Kossakowski. From Markovian semigroup to non-Markovian quantum evolution. 2010. arXiv:1010.4745.
- [92] H.-P. Breuer and B. Vacchini. Quantum semi-Markov processes. *Phys. Rev. Lett.*, 101:140402, 2008.
- [93] H.-P. Breuer and B. Vacchini. Structure of completely positive quantum master equations with memory kernel. *Phys. Rev. E*, 79:041147, 2009.
- [94] A. A. Budini. Stochastic representation of a class of non-Markovian completely positive evolutions. *Phys. Rev. A*, 69:042107, 2004.

-
- [95] J. T. Stockburger and H. Grabert. Exact c-number representation of non-Markovian quantum dissipation. *Phys. Rev. Lett.*, 88:170407, 2002.
- [96] S. Daffer, K. Wódkiewicz, J. D. Cresser, and J. K. McIver. Depolarizing channel as a completely positive map with memory. *Phys. Rev. A*, 70:010304, 2004.
- [97] J. Piilo, S. Maniscalco, K. Harkonen, and K.-A. Suominen. Non-Markovian quantum jumps. *Phys. Rev. Lett.*, 100:180402, 2008.
- [98] A. Barchielli, C. Pellegrini, and F. Petruccione. Stochastic Schrödinger equations with coloured noise. *Europhys. Lett.*, 91:24001, 2010.
- [99] C. A. Fuchs and J. van de Graaf. Cryptographic distinguishability measures for quantum mechanical states. *IEEE Trans. Inf. Th.*, 45:1216, 1999.
- [100] D. Chruściński, A. Kossakowski, and A. Rivas. Measures of non-Markovianity: Divisibility versus backflow of information. *Phys. Rev. A*, 83:052128, 2011.
- [101] V. Karimipour and L. Memarzadeh. Linking classical and quantum stochastic processes. 2011. arXiv:1105:2728.
- [102] N. van Kampen. Remarks on non-Markov processes. *Braz. J. Phys.*, 28:90, 1998.
- [103] D. T. Gillespie. Describing the state of a stochastic process. *Am. J. Phys.*, 66:533, 1998.
- [104] N.G.van Kampen. *Stochastic Processes in Physics and Chemistry*. North-Holland, Amsterdam, 1992.
- [105] D. T. Gillespie. *Markov Processes: An Introduction for Physical Scientists*. Academic, San Diego, 1992.
- [106] W. Feller. Non-Markovian processes with the semigroup property. *Ann. Mat. Statist.*, 30:1252, 1959.
- [107] D. T. Gillespie, W. O. Alltop, and J. M. Martin. Modeling quantum measurement probability as a classical stochastic process. *Chaos*, 11:548, 2001.
- [108] P. Hänggi and H. Thomas. Time evolution, correlations, and linear response of non-Markov processes. *Z. Physik B*, 26:85, 1977.
- [109] H. Grabert, P. Talkner, and P. Hänggi. Microdynamics and time-evolution of macroscopic non-Markovian systems. *Z. Physik B*, 26:389, 1977.
- [110] H. Grabert, P. Talkner, and P. Hänggi. Microdynamics and time-evolution of macroscopic non-Markovian systems. II. *Z. Physik B*, 29:273, 1978.
- [111] P. Hänggi, H. Thomas, H. Grabert, and P. Talkner. Note on time evolution of non-Markov processes. *J. Stat. Phys.*, 18:155, 1978.

- [112] P. Hänggi and H. Thomas. Stochastic processes: time evolution, symmetries and linear response. *Phys. Rep.*, 88:207, 1982.
- [113] W. Feller. *An introduction to probability theory and its applications. Vol. II.* John Wiley & Sons Inc., New York, 1971.
- [114] S. M. Ross. *Introduction to Probability Models.* Academic Press, Burlington, MA, 2007.
- [115] W. Feller. On semi-Markov processes. *Proc. Nat. Acad. Sci. U.S.A.*, 51:653, 1964.
- [116] D. T. Gillespie. Master equations for random walks with arbitrary pausing time distributions. *Phys. Lett. A*, 64:22, 1977.
- [117] J. R. Norris. *Markov Chains.* Cambridge University Press, Cambridge, 1999.
- [118] D. R. Cox and H. D. Miller. *The Theory of Stochastic Processes.* John Wiley & Sons Inc., New York, 1965.
- [119] J. Medhi. *Stochastic Processes.* John Wiley & Sons, New York, 1994.
- [120] I. M. Sokolov. Solutions of a class of non-Markovian Fokker-Planck equations. *Phys. Rev. E*, 66:041101, 2002.
- [121] T. J. G. Apollaro, C. Di Franco, F. Plastina, and M. Paternostro. Memory-keeping effects and forgetfulness in the dynamics of a qubit coupled to a spin chain. *Phys. Rev. A*, 83:032103, 2011.
- [122] P. Haikka, S. McEndoo, G. de Chiara, M. Palma, and S. Maniscalco. Quantifying, characterizing and controlling information flow in ultracold atomic gases. *Phys. Rev. A*, 84:031602, 2011.
- [123] P. Rebentrost and A. Aspuru-Guzik. Communication: Exciton-phonon information flow in the energy transfer process of photosynthetic complexes. *J. Chem. Phys.*, 134:101103, 2011.
- [124] S. Lorenzo, F. Plastina, and M. Paternostro. Role of environmental correlations in the non-Markovian dynamics of a spin system. *Phys. Rev. A*, 84:032124, 2011.
- [125] J. Helm and W. T. Strunz. Quantum decoherence of two qubits. *Phys. Rev. A*, 80:042108, 2009.
- [126] P. Kaer, T. R. Nielsen, P. Lodahl, A.-P. Jauho, and J. Mørk. Non-Markovian model of photon-assisted dephasing by electron-phonon interactions in a coupled quantum-dot-cavity system. *Phys. Rev. Lett.*, 104:157401, 2010.
- [127] J.-S. Xu, C.-F. Li, C.-J. Zhang, X.-Y. Xu, Y.-S. Zhang, and G.-C. Guo. Experimental investigation of the non-Markovian dynamics of classical and quantum correlations. *Phys. Rev. A*, 82:042328, 2010.

-
- [128] M. Žnidarič, C. Pineda, and I. García-Mata. Non-Markovian behavior of small and large complex quantum systems. *Phys. Rev. Lett.*, 107:080404, 2011.
- [129] P. Haikka, J. D. Cresser, and S. Maniscalco. Comparing different non-Markovianity measures in a driven qubit system. *Phys. Rev. A*, 83:012112, 2011.
- [130] G. Lindblad. Non-Markovian quantum stochastic processes and their entropy. *Commun. math. Phys.*, 65:281, 1979.
- [131] L. Accardi, A. Frigerio, and J.T. Lewis. Quantum stochastic processes. *Publ. RIMS, Kyoto Univ.*, 18:97, 1982.
- [132] A.-m. Kuah, K. Modi, C.A. Rodríguez-Rosario, and E.C.G. Sudarshan. How state preparation can affect a quantum experiment: Quantum process tomography for open systems. *Phys. Rev. A*, 76:042113, 2007.
- [133] S. Tasaki, K. Yuasa, P. Facchi, G. Kimura, H. Nakazato, Ohba, and S. Pascazio. On the assumption of initial factorization in the master equation for weakly coupled systems I: General framework. *Ann. Phys.*, 322:631, 2007.
- [134] K. Yuasa, S. Tasaki, P. Facchi, G. Kimura, H. Nakazato, I. Ohba, and S. Pascazio. On the assumption of initial factorization in the master equation for weakly coupled systems I: General framework. *Ann. Phys.*, 322:657, 2007.
- [135] V. Hakim and V. Ambegaokar. Quantum theory of a free particle interacting with a linearly dissipative environment. *Phys. Rev. A*, 32:423, 1985.
- [136] H. Grabert, P. Schramm, and G.-L. Ingold. Quantum Brownian motion: the functional integral approach. *Phys. Rep.*, 168:115, 1988.
- [137] V. Gorini, M. Verri, and A. Frigerio. Non-Markovian behaviour in low-temperature damping. *Phys. A*, 161:357, 1989.
- [138] L. D. Romero and J. P. Paz. Decoherence and initial correlations in quantum Brownian motion. *Phys. Rev. A*, 55:4070, 1997.
- [139] C. Uchiyama and M. Aihara. Role of initial quantum correlation in transient linear response. *Phys. Rev. A*, 82:044104, 2010.
- [140] A. G. Dijkstra and Y. Tanimura. Non-Markovian entanglement dynamics in the presence of system-bath coherence. *Phys. Rev. Lett.*, 104:250401, 2010.
- [141] Y.-J. Zhang, X.-B. Zou, Y.-J. Xia, and G.-C. Guo. Different entanglement dynamical behaviors due to initial system-environment correlations. *Phys. Rev. A*, 82:022108, 2010.
- [142] E. Lutz. Effect of initial correlations on short-time decoherence. *Phys. Rev. A*, 67:022109, 2003.

- [143] B. Bellomo, G. Compagno, and F. Petruccione. Initial correlations effects on decoherence at zero temperature. *J. Phys. A: Math. Gen.*, 38:10203, 2003.
- [144] V.G. Morozov, S. Mathey, and G. Röpke. Decoherence in an exactly solvable qubit model with initial qubit-environment correlations. 2011. arXiv:1106.5654.
- [145] H.-P. Breuer. Non-Markovian generalization of the Lindblad theory of open quantum systems. *Phys. Rev. A*, 75:022103, 2007.
- [146] P. Štelmachovič and V. Bužek. Dynamics of open quantum systems initially entangled with environment: Beyond the Kraus representation. *Phys. Rev. A*, 64:062106, 2001.
- [147] T. F. Jordan. Affine maps of density matrices. *Phys. Rev. A*, 71:034101, 2005.
- [148] T. F. Jordan, A. Shaji, and E.C.G. Sudarshan. Dynamics of initially entangled open quantum systems. *Phys. Rev. A*, 70:052110, 2004.
- [149] C. A. Rodríguez-Rosario, K. Modi, A.-m. Kuah, A. Shaji, and E. C. G. Sudarshan. Completely positive maps and classical correlations. *J. Phys. A: Math. Gen.*, 41:205301, 2008.
- [150] T. F. Jordan, A. Shaji, and E.C.G. Sudarshan. Mapping the Schrödinger picture of open quantum dynamics. *Phys. Rev. A*, 73:012106, 2006.
- [151] A. Shabani and D. A. Lidar. Vanishing quantum discord is necessary and sufficient for completely positive maps. *Phys. Rev. Lett.*, 102:100402, 2009.
- [152] A. Shabani and D. A. Lidar. Maps for general open quantum systems and a theory of linear quantum error correction. *Phys. Rev. A*, 80:012309, 2009.
- [153] H. Hayashi, G. Kimura, and Y. Ota. Kraus representation in the presence of initial correlations. *Phys. Rev. A*, 67:062109, 2003.
- [154] H. A. Carteret, D. R. Terno, and K. Życzkowski. Dynamics beyond completely positive maps: Some properties and applications. *Phys. Rev. A*, 77:042113, 2008.
- [155] K. M. Fonseca Romero, P. Talkner, and P. Hänggi. Is the dynamics of open quantum systems always linear? *Phys. Rev. A*, 69:052109, 2004.
- [156] C. A. Rodríguez-Rosario, K. Modi, and A. Aspuru-Guzik. Linear assignment maps for correlated system-environment states. *Phys. Rev. A*, 81:012313, 2010.
- [157] A. Shaji and E.C.G. Sudarshan. Who's afraid of not completely positive maps? *Phys. Lett. A*, 341:48, 2005.
- [158] F. Masillo, G. Sclarici, and L. Solombrino. Some remarks on assignment maps. *J. Math. Phys.*, 52:012101, 2011.
- [159] I. Burghardt. Reduced dynamics with initial correlations: Multiconfigurational approach. *J. Chem. Phys.*, 114:89, 2001.

-
- [160] H.-P. Breuer, J. Gemmer, and M. Michel. Non-Markovian quantum dynamics: Correlated projection superoperators and Hilbert space averaging. *Phys. Rev. E*, 73:016139, 2006.
- [161] A.A. Budini. Lindblad rate equations. *Phys. Rev. A*, 74:053815, 2006.
- [162] J. Fischer and H.-P. Breuer. Correlated projection operator approach to non-Markovian dynamics in spin baths. *Phys. Rev. A*, 76:052119, 2007.
- [163] K. Kassner. Quantum relaxation with initial system-bath correlations. *Phys. Rev. A*, 36:5381, 1987.
- [164] A. A. Budini. Random Lindblad equations from complex environments. *Phys. Rev. E*, 72:056106, 2005.
- [165] B. Vacchini. Non-Markovian dynamics for bipartite systems. *Phys. Rev. A*, 78:022112, 2008.
- [166] A. Barchielli and C. Pellegrini. Jump-diffusion unravelling of a non-Markovian generalized Lindblad master equation. *J. Math. Phys.*, 51:112104, 2010.
- [167] A. Barchielli and M. Gregoratti. *Quantum Trajectories And Measurements In Continuous Time: The Diffusive Case*, volume 782 of *Lecture Notes in Physics*. Springer & Heidelberg, Berlin, 2009.
- [168] M. Gessner and H.-P. Breuer. Detecting nonclassical system-environment correlations by local operations. *Phys. Rev. Lett.*, 107:180402, 2011.
- [169] C.-F. Li, J.-S. Tang, Y.-L. Li, and G.-C. Guo. Experimentally witnessing the initial correlation between an open quantum system and its environment. *Phys. Rev. A*, 83:064102, 2011.
- [170] C. C. Gerry and P. L. Knight. *Introductory Quantum Optics*. Cambridge University Press, Cambridge, 2005.
- [171] A. Joobeur, B. E. A. Saleh, and M. C. Teich. Spatiotemporal coherence properties of entangled light beams generated by parametric down-conversion. *Phys. Rev. A*, 50:3349, 1994.
- [172] S. Cialdi, F. Castelli, and M.G.A. Paris. Properties of entangled photon pairs generated by a CW laser with small coherence time: theory and experiment. *J. Mod. Opt.*, 56:215, 2009.
- [173] D. Brivio. *A novel source of entangled states for quantum information applications*. PhD thesis, Università degli Studi di Milano, Italy, 2011.
- [174] L. Hardy. Source of photons with correlated polarisations and correlated directions. *Phys. Lett. A*, 161:326, 1992.
- [175] P.G. Kwiat, E. Waks, A. G. White, I. Appelbaum, and P.H. Eberhard. Ultrabright source of polarization-entangled photons. *Phys. Rev. A*, 60:R733, 1999.

- [176] S. Cialdi, D. Brivio, and M.G.A. Paris. Demonstration of a programmable source of two-photon multiqubit entangled states. *Phys. Rev. A*, 81:042322, 2010.
- [177] S. Cialdi, D. Brivio, and M.G.A. Paris. Programmable purification of type-I polarization-entanglement. *Appl. Phys. Lett.*, 97:041108, 2010.
- [178] S. Cialdi, F. Castelli, I. Boscolo, and M.G.A. Paris. Generation of entangled photon pairs using small-coherence-time continuous wave pump lasers. *Appl. Opt.*, 47:1832, 2008.
- [179] R. Rangarajan, M. Goggin, and P. Kwiat. Optimizing type-I polarization-entangled photons. *Opt. Expr.*, 17:18920, 2009.
- [180] S. Cialdi, D. Brivio, E. Tesio, and M.G.A. Paris. Programmable entanglement oscillations in a non-Markovian channel. *Phys. Rev. A*, 83:042308, 2011.
- [181] J. Dajka and J. Łuczka. Distance growth of quantum states due to initial system-environment correlations. *Phys. Rev. A*, 82:012341, 2010.
- [182] A. R. Usha Devi, A. K. Rajagopal, and Sudha. Open-system quantum dynamics with correlated initial states, not completely positive maps, and non-Markovianity. *Phys. Rev. A*, 83:022109, 2011.
- [183] K. Banaszek, G. M. D'Ariano, M. G. A. Paris, and M. F. Sacchi. Maximum-likelihood estimation of the density matrix. *Phys. Rev. A*, 61:010304(R), 1999.
- [184] D. F. V. James, P. G. Kwiat, W. J. Munro, and A. G. White. Measurement of qubits. *Phys. Rev. A*, 64:052312, 2001.
- [185] C. Corduneanu. *Almost Periodic Functions*. Chelsea Publishing Company, New York, 1989.
- [186] B. Militello F. Anzà and A. Messina. Tripartite thermal correlations in an inhomogeneous spin-star system. *J. Phys. B*, 43:205501, 2010.
- [187] P. Meystre and M. Sargent III. *Elements of Quantum Optics*. Springer-Verlag, Berlin, 1991.
- [188] K. Hornberger, S. Uttenthaler, B. Brezger, L. Hackermüller, M. Arndt, and A. Zeilinger. Collisional decoherence observed in matter wave interferometry. *Phys. Rev. Lett.*, 90:160401, 2003.
- [189] K. Hornberger, J.E. Sipe, and M. Arndt. Theory of decoherence in a matter wave Talbot-Lau interferometer. *Phys. Rev. A*, 70:053608, 2004.
- [190] J. R. Taylor. *Scattering Theory*. John Wiley & Sons, New York, 1972.
- [191] K. Hornberger. Monitoring approach to open quantum dynamics using scattering theory. *Europhys. Lett.*, 77:50007, 2007.

-
- [192] K. Hornberger and B. Vacchini. Monitoring derivation of the quantum linear Boltzmann equation. *Phys. Rev. A*, 77:022112, 2008.
- [193] B. Vacchini and K. Hornberger. Quantum linear Boltzmann equation. *Phys. Rep.*, 478:71, 2009.
- [194] R. Martinazzo, B. Vacchini, K.H. Hugues, and I. Burghardt. Communication: Universal Markovian reduction of Brownian particle dynamics. *J. Chem. Phys*, 134:011101, 2011.
- [195] R. Alicki and S. Kryszewski. Completely positive Bloch-Boltzmann equation. *Phys. Rev. A*, 68:013809, 2003.
- [196] C. M. Savage and D. F. Walls. Damping of quantum coherence: The master-equation approach. *Phys. Rev. A*, 32:2316, 1985.
- [197] A. A. Budini and H. Schomerus. Non-Markovian master equations from entanglement with stationary unobserved degrees of freedom. *J. Phys. A: Math. Gen.*, 38:9251, 2005.
- [198] D. Chruściński, A. Kossakowski, and S. Pascazio. Long-time memory in non-Markovian evolutions. *Phys. Rev. A*, 81:032101, 2010.
- [199] C. J. Hemming and R. V. Krems. Collisional decoherence of internal-state superpositions in a trapped ultracold gas. *Phys. Rev. A*, 81:052701, 2010.
- [200] K. Hornberger. Thermal limitation of far-field matter-wave interference. *Phys. Rev. A*, 73:052102, 2006.
- [201] D. A. Kokorowski, A. D. Cronin, T. D. Roberts, and D. E. Pritchard. From single- to multiple-photon decoherence in an atom interferometer. *Phys. Rev. Lett.*, 86:2191, 2001.
- [202] R. Vasile, S. Maniscalco, M.G.A. Paris, H.-P. Breuer, and J. Piilo. Quantifying non-Markovianity of continuous variable Gaussian dynamical maps. *Phys. Rev. A*, 84:052118, 2011.
- [203] X. Wang and S.G. Schirmer. Contractivity of the Hilbert-Schmidt distance under open-system dynamics. *Phys. Rev. A*, 79:052326, 2009.
- [204] K.M.R. Audenaert. Telescopic relative entropy. 2011. arXiv:1102.3040.
- [205] J. Dajka, J. Łuczka, and P. Hänggi. Distance between quantum states in the presence of initial qubit-environment correlations: A comparative study. *Phys. Rev. A*, 84:032120, 2011.
- [206] A. Pazy. *Semigroups of Linear Operators and Applications to Partial Differential Equations*, volume 44 of *Applied Mathematical Sciences*. Springer, Berlin, 1983.
- [207] R. Alicki and K. Lendi. *Quantum Dynamical Semigroups and Applications*, volume 286 of *Lecture Notes in Physics*. Springer, Berlin, 1987.

- [208] K.-J. Engel and R. Nagel. *One-Parameter Semigroups for Linear Evolution Equations*,. Springer, New York, 2000.
- [209] E. Hille. *Functional Analysis and Semi-groups*, volume 31. Amer. Math. Soc. Colloq. Publ., New York, 1948.
- [210] K. Yosida. On the differentiability and the representation of one- parameter semigroups of linear operators. *J. Math. Soc. Japan.*, 1:15, 1948.
- [211] E. Størmer. *Positive linear maps of C^* -algebras*, volume 29 of *Lecture Notes in Physics*. Springer, Berlin, 1974.
- [212] A. Kossakowski. On necessary and sufficient conditions for a generator of a quantum dynamical semi-group. *Bull. Acad. Polon. Sci. Math.*, 20:1021, 1972.
- [213] M. B. Ruskai. Beyond strong subadditivity? Improved bounds on the contraction of generalized relative entropy. *Rev. Math. Phys.*, 6:1147, 1994.
- [214] A. Gilchrist, N. K. Langford, and M. A. Nielsen. Distance measures to compare real and ideal quantum processes. *Phys. Rev. A*, 71:062310, 2005.
- [215] B.-H. Liu, L. Li, Y.-F. Huang, C.-F. Li, G.-C. Guo, E.-M. Laine, H.-P. Breuer, and J. Piilo. Experimental control of the transition from Markovian to non-Markovian dynamics of open quantum systems. *Nature Phys.*, 7:931, 2011.
- [216] J.-S. Tang, C.-F. Li, Y.-L. Li, X.-B. Zou, G.-C. Guo, H.-P. Breuer, E.-M. Laine, and J. Piilo. Measuring non-Markovianity of processes with controllable system-environment interaction. *Europhys. Lett.*, 97:1002, 2012.